

UPDATED: 2026-05-05

TECHNICAL MANUAL

NOKIAN HEAVY TYRES

nokian[®]
TYRES

TABLE OF CONTENTS

| | | | |
|---|-----------|---|------------|
| FORESTRY | 4 | ALL TERRAIN TRUCKS AND MILITARY VEHICLES | 88 |
| TR FOREST | 6 | MPT AGILE | 90 |
| LOGGER KING LS-2 EXTREME | 19 | TRUCKS AND BUSES | 93 |
| FOREST KING T | 22 | HAKKAPOLIITTA TRUCK F2 | 95 |
| AGRICULTURAL AND CONTRACTING | 25 | E-TRUCK DRIVE | 97 |
| TRI 2 EXTREME STEEL | 27 | HAKKA TRUCK 844 | 99 |
| CT | 35 | E-TRUCK TRAILER | 101 |
| ELS | 38 | HAKKA TRUCK STEER | 103 |
| COUNTRY KING | 43 | HAKKAPOLIITTA TRUCK D2 | 105 |
| UNDERGROUND MINING | 48 | GENERAL INFO | 107 |
| ARMOR GARD MINE | 50 | TIRE MARKINGS | 108 |
| MINE E-3 | 54 | TIRE STRUCTURES | 115 |
| PORTS AND TERMINALS | 57 | INFLATION PRESSURE | 116 |
| HTS E-4 | 59 | LIQUID AND SALT BALLASTING | 118 |
| HTS E-3 | 64 | TRACTOR AND LOADER TIRES FOR WINTER APPLICATION | 119 |
| RTG | 67 | NON-SKID CHAINS | 121 |
| NORDMAN HARBOUR | 70 | TRACKS | 122 |
| HTS L-4S | 73 | RIMS | 123 |
| EARTHMOVING AND ROAD MAINTENANCE | 77 | | |
| GRS | 79 | | |
| EXCAVATOR | 83 | | |

| | | | |
|---|------------|--|------------|
| RIM MARKINGS | 124 | STUDS AND CHAINS | 199 |
| WHEEL STUD HOLES AND COUNTERSINKS | 125 | MPT AGILE STUD RECOMMENDATIONS | 203 |
| RIM CONTOURS | 129 | MOUNTING TIRES ON FOUR WHEEL DRIVE TRACTORS | 204 |
| WHEEL MAIN DIMENSIONS | 130 | MINE TIRE MAINTENANCE | 206 |
| WHEEL PARTS / COMPONENTS | 131 | HAKKAPELIITTA LOADER INFLATION PRESSURE RECOMMENDATIONS FOR DIFFERENT WHEEL LOADERS | 207 |
| FORESTRY RIMS | 132 | GROUND KARE AND EXCAVATOR MOUNTING RECOMMENDATIONS | 210 |
| KNURLING | 133 | NOKIAN TYRES INTUITU™ SMART TIRES | 212 |
| TUBELESS FORESTRY RIMS | 134 | REGROOVING OF NOKIAN TYRES TRUCK AND BUS TIRES | 215 |
| INDUSTRIAL AND EM MULTI-PIECE WHEELS | 135 | REGROOVING RECOMMENDATIONS | 216 |
| FLAPS AND O-RINGS | 137 | STUDDING OF NOKIAN TYRES HAKKAPELIITTA TRUCK BRANDED TIRES | 219 |
| INSPECTIONS ON RIMS | 140 | AREAS OF USE AND EU LABEL INFO | 220 |
| TIRE MOUNTING CLAMPS | 141 | HOW TO USE LOAD CAPACITY TABLES | 222 |
| TUBES AND VALVES | 143 | LIMITED WARRANTY | 224 |
| TIRE CHOICE AND INFLATION PRESSURES BY APPLICATION | 144 | GENERAL TERMS OF DELIVERY | 225 |
| GROUND CONTACT PRESSURE COMPARISON | 190 | | |
| CONTACT AREAS ON A HARD DRIVING SURFACE | 196 | | |



FORESTRY

The unique qualities of Nokian forestry tires arise from decades of experience on the forestry machinery and the extreme working conditions. This continuous forefront product development is based on close dialogue with customers and the respect for the nature. Understanding the application leads to high quality products giving customers added value in safety, reliability and cost per hour.

nokian
TYRES

FORESTRY TIRES

TRACTOR



6

**Nokian Tyres
TR Forest**

OTHER VEHICLES



19

**Nokian Tyres
Logger King
LS-2 Extreme**



22

**Nokian Tyres
Forest King T**

NOKIAN TYRES TR FOREST

RELIABLE TIRE FOR TRACTORS IN FORESTRY USE

- Tread pattern giving excellent traction
- Good self cleaning properties
- Tread compound developed especially for forestry use

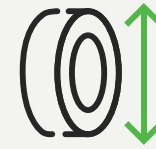

AVAILABLE SIZES

- 12.4-24 - T482192
- 13.6-24 - T482198
- 14.9-24 - T482220
- 13.6-28 - T483150
- 14.9-28 - T445409
- 16.9-28 - T483301
- 16.9-30 - T483810
- 16.9-34 - T484390
- 18.4-34 - T484420
- 18.4-38 - T485430
- 20.8-38 - T485450

NOKIAN TYRES TR FOREST

ALL SIZES

| Product code | Size | LI/SS | Ply rating | TL/TT | Rim | Permitted rims | Width (mm) | Diameter (mm) | Loaded static radius (mm) | Rolling circumference (mm) | Pressure (kPa) | Max. inflation pressure (kPa) | Tread depth (mm) | Tread code | Tube product code | Load capacity for forestry service (lt), kg | Load capacity for road, kg | | | | |
|--------------|---------|--------------|------------|-------|------|---------------------|------------|---------------|---------------------------|----------------------------|----------------|-------------------------------|------------------|------------|-------------------|---|----------------------------|------|------|------|------|
| | | | | | | | | | | | | | | | | Speed (km/h) | Speed (km/h) | | | | |
| | | | | | | | | | | | | | | | | | 10 | 10 | 20 | 30 | 40 |
| T482192 | 12.4-24 | 128A8 (125B) | 12 | TT | DW11 | DW10, W11, W10, W9 | 312 | 1156 | 538 | 3443 | 350 | 350 | 41 | R-1 | T55100 | 2215 | 2700 | 2215 | 1930 | 1800 | 1640 |
| T482198 | 13.6-24 | 128A8 (125B) | 10 | TT | DW12 | DW11, W12, W11 | 342 | 1183 | 548 | 3512 | 250 | 250 | 46 | R-1 | T55105 | 2215 | 2700 | 2215 | 1930 | 1800 | 1640 |
| T482220 | 14.9-24 | 138A8 (134B) | 14 | TT | DW13 | DW12, W13, W12, W11 | 375 | 1262 | 582 | 3707 | 300 | 300 | 44 | R-1 | T55112 | 2905 | 3540 | 2905 | 2530 | 2360 | 2150 |
| T483150 | 13.6-28 | 130A8 (127B) | 10 | TT | DW12 | DW11, W12, W11 | 336 | 1321 | 609 | 3934 | 250 | 250 | 33 | R-1 | T55105 | 2335 | 2850 | 2335 | 2040 | 1900 | 1730 |
| T445409 | 14.9-28 | 140A8 (137B) | 14 | TT | DW13 | DW12, W13, W12, W11 | 390 | 1353 | 635 | 4065 | 300 | 300 | 38 | R-1 | T55351 | 3075 | 3750 | 3075 | 2680 | 2500 | 2280 |
| T483301 | 16.9-28 | 145A8 (142B) | 14 | TT | DW15 | DW14, W15L, W14L | 440 | 1426 | 662 | 4291 | 270 | 270 | 42 | R-1 | T55370 | 3565 | 4350 | 3565 | 3120 | 2900 | 2640 |
| T483810 | 16.9-30 | 144A8 (141B) | 14 | TT | DW15 | DW14, W15L, W14L | 434 | 1465 | 683 | 4361 | 260 | 260 | 45 | R-1 | T55371 | 3445 | 4200 | 3445 | 3000 | 2800 | 2550 |
| T484390 | 16.9-34 | 146A8 (143B) | 14 | TT | DW15 | DW14, W15L, W14L | 432 | 1562 | 742 | 4599 | 260 | 260 | 45 | R-1 | T55391 | 3690 | 4500 | 3690 | 3220 | 3000 | 2730 |
| T484420 | 18.4-34 | 154A8 (151B) | 14 | TT | DW16 | DW15, W16L, W15L | 478 | 1629 | 765 | 4825 | 260 | 260 | 48 | R-1 | T55391 | 4615 | 5625 | 4615 | 4020 | 3750 | 3420 |
| T485430 | 18.4-38 | 155A8 (152B) | 14 | TT | DW16 | DW15, W16L, W15L | 468 | 1738 | 819 | 5150 | 260 | 260 | 53 | R-1 | T55430 | 4765 | 5815 | 4765 | 4160 | 3875 | 3540 |
| T485450 | 20.8-38 | 159A8 (156B) | 14 | TT | DW18 | DW16, W18L, W16L | 538 | 1825 | 853 | 5510 | 230 | 230 | 53 | R-1 | | 5380 | 6565 | 5380 | 4700 | 4375 | 4000 |

NOKIAN TYRES TR FOREST 12.4-24 - T482192

| Product code | Size | LI/SS | Ply rating | TL/TT | Rim | Permitted rims | Width (mm) | Diameter (mm) | Loaded static radius (mm) | Rolling circumference (mm) | Pressure (kPa) | Max. inflation pressure (kPa) | Tread depth (mm) | Tread code | Tube product code |
|--------------|---------|--------------|------------|-------|------|--------------------|------------|---------------|---------------------------|----------------------------|----------------|-------------------------------|------------------|------------|-------------------|
| T482192 | 12.4-24 | 128A8 (125B) | 12 | TT | DW11 | DW10, W11, W10, W9 | 312 | 1156 | 538 | 3443 | 350 | 350 | 41 | R-1 | T55100 |

LOAD CAPACITY FOR TRACTOR, KG

| Pressure (kPa) | Forestry service (LT) | Road | | | | |
|----------------|-----------------------|------------|---------|---------------|---------|---------|
| | | 10 km/h LT | 20 km/h | 30 km/h 10 HT | 40 km/h | 50 km/h |
| 120 | 1255 | 1530 | 1255 | 1090 | 1020 | 930 |
| 160 | 1525 | 1860 | 1525 | 1325 | 1240 | 1130 |
| 200 | 1685 | 2055 | 1685 | 1465 | 1370 | 1245 |
| 240 | 1785 | 2175 | 1785 | 1550 | 1450 | 1320 |
| 280 | 1960 | 2395 | 1960 | 1705 | 1595 | 1450 |
| 320 | 2115 | 2580 | 2115 | 1840 | 1720 | 1565 |
| 350 | 2215 | 2700 | 2215 | 1930 | 1800 | 1640 |

WATER AND SALT BALLASTING

| Tire volume 100% | | Water filling 75% | | Water/salt filling (75% / -30°C) | | | | Total weight increase | |
|------------------|---------|-------------------|---------|----------------------------------|---------|------|-----|-----------------------|-----|
| Litres | Gallons | Litres | Gallons | Water | | Salt | | kg | lbs |
| | | | | Litres | Gallons | kg | lbs | | |
| 150 | 40 | 113 | 30 | 92 | 24 | 47 | 104 | 139 | 306 |

(CaCl2, 75%, -30°C) Always use a tube when filled with water/salt.

TUBES AND VALVES

| Tube product code | Tube valve |
|-------------------|------------|
| T55100 | TR218A |

STUDDABLE

| Studdable | Number of studs |
|-----------|-----------------|
| Yes | 108 pcs |

NOKIAN TYRES TR FOREST 13.6-24 - T482198

| Product code | Size | LI/SS | Ply rating | TL/TT | Rim | Permitted rims | Width (mm) | Diameter (mm) | Loaded static radius (mm) | Rolling circumference (mm) | Pressure (kPa) | Max. inflation pressure (kPa) | Tread depth (mm) | Tread code | Tube product code |
|--------------|---------|--------------|------------|-------|------|----------------|------------|---------------|---------------------------|----------------------------|----------------|-------------------------------|------------------|------------|-------------------|
| T482198 | 13.6-24 | 128A8 (125B) | 10 | TT | DW12 | DW11, W12, W11 | 342 | 1183 | 548 | 3512 | 250 | 250 | 46 | R-1 | T55105 |

LOAD CAPACITY FOR TRACTOR, KG

| Pressure (kPa) | Forestry service (LT) | Road | | | | |
|----------------|-----------------------|------------|---------|---------------|---------|---------|
| | 10 km/h LT | 10 km/h LT | 20 km/h | 30 km/h 10 HT | 40 km/h | 50 km/h |
| 120 | 1520 | 1855 | 1520 | 1320 | 1235 | 1125 |
| 160 | 1855 | 2265 | 1855 | 1615 | 1510 | 1375 |
| 200 | 2035 | 2485 | 2035 | 1770 | 1655 | 1505 |
| 250 | 2215 | 2700 | 2215 | 1930 | 1800 | 1640 |

WATER AND SALT BALLASTING

| Tire volume 100% | | Water filling 75% | | Water/salt filling (75% / -30°C) | | | | Total weight increase | |
|------------------|---------|-------------------|---------|----------------------------------|---------|------|-----|-----------------------|-----|
| Litres | Gallons | Litres | Gallons | Water | | Salt | | kg | lbs |
| | | | | Litres | Gallons | kg | lbs | | |
| 180 | 48 | 135 | 36 | 111 | 29 | 56 | 124 | 167 | 368 |

(CaCl2, 75%, -30°C) Always use a tube when filled with water/salt.

TUBES AND VALVES

| Tube product code | Tube valve |
|-------------------|------------|
| T55105 | TR218A |

STUDDABLE

| Studdable | Number of studs |
|-----------|-----------------|
| Yes | 108 pcs |

NOKIAN TYRES TR FOREST 14.9-24 - T482220

| Product code | Size | LI/SS | Ply rating | TL/TT | Rim | Permitted rims | Width (mm) | Diameter (mm) | Loaded static radius (mm) | Rolling circumference (mm) | Pressure (kPa) | Max. inflation pressure (kPa) | Tread depth (mm) | Tread code | Tube product code |
|--------------|---------|--------------|------------|-------|------|---------------------|------------|---------------|---------------------------|----------------------------|----------------|-------------------------------|------------------|------------|-------------------|
| T482220 | 14.9-24 | 138A8 (134B) | 14 | TT | DW13 | DW12, W13, W12, W11 | 375 | 1262 | 582 | 3707 | 300 | 300 | 44 | R-1 | T55112 |

LOAD CAPACITY FOR TRACTOR, KG

| Pressure (kPa) | Forestry service (LT) | Road | | | | |
|----------------|-----------------------|------------|---------|---------------|---------|---------|
| | 10 km/h LT | 10 km/h LT | 20 km/h | 30 km/h 10 HT | 40 km/h | 50 km/h |
| 120 | 1785 | 2175 | 1785 | 1550 | 1450 | 1320 |
| 160 | 2175 | 2655 | 2175 | 1895 | 1770 | 1610 |
| 200 | 2390 | 2920 | 2390 | 2080 | 1945 | 1770 |
| 240 | 2550 | 3115 | 2550 | 2220 | 2075 | 1890 |
| 280 | 2800 | 3415 | 2800 | 2435 | 2275 | 2070 |
| 300 | 2905 | 3540 | 2905 | 2530 | 2360 | 2150 |

WATER AND SALT BALLASTING

| Tire volume 100% | | Water filling 75% | | Water/salt filling (75% / -30°C) | | | | Total weight increase | |
|------------------|---------|-------------------|---------|----------------------------------|---------|------|-----|-----------------------|-----|
| | | | | Water | | Salt | | | |
| Litres | Gallons | Litres | Gallons | Litres | Gallons | kg | lbs | kg | lbs |
| 240 | 63 | 180 | 48 | 148 | 39 | 75 | 166 | 223 | 492 |

(CaCl2, 75%, -30°C) Always use a tube when filled with water/salt.

TUBES AND VALVES

| Tube product code | Tube valve |
|-------------------|------------|
| T55112 | TR218A |

STUDDABLE

| Studdable | Number of studs |
|-----------|-----------------|
| Yes | 114 pcs |

NOKIAN TYRES TR FOREST 13.6-28 - T483150

| Product code | Size | LI/SS | Ply rating | TL/TT | Rim | Permitted rims | Width (mm) | Diameter (mm) | Loaded static radius (mm) | Rolling circumference (mm) | Pressure (kPa) | Max. inflation pressure (kPa) | Tread depth (mm) | Tread code | Tube product code |
|--------------|---------|--------------|------------|-------|------|----------------|------------|---------------|---------------------------|----------------------------|----------------|-------------------------------|------------------|------------|-------------------|
| T483150 | 13.6-28 | 130A8 (127B) | 10 | TT | DW12 | DW11, W12, W11 | 336 | 1321 | 609 | 3934 | 250 | 250 | 33 | R-1 | T55105 |

LOAD CAPACITY FOR TRACTOR, KG

| Pressure (kPa) | Forestry service (LT) | Road | | | | |
|----------------|-----------------------|------------|---------|---------------|---------|---------|
| | 10 km/h LT | 10 km/h LT | 20 km/h | 30 km/h 10 HT | 40 km/h | 50 km/h |
| 120 | 1600 | 1950 | 1600 | 1390 | 1300 | 1185 |
| 160 | 1960 | 2395 | 1960 | 1705 | 1595 | 1450 |
| 200 | 2155 | 2625 | 2155 | 1875 | 1750 | 1595 |
| 250 | 2335 | 2850 | 2335 | 2040 | 1900 | 1730 |

WATER AND SALT BALLASTING

| Tire volume 100% | | Water filling 75% | | Water/salt filling (75% / -30°C) | | | | Total weight increase | |
|------------------|---------|-------------------|---------|----------------------------------|---------|------|-----|-----------------------|-----|
| Litres | Gallons | Litres | Gallons | Water | | Salt | | kg | lbs |
| | | | | Litres | Gallons | kg | lbs | | |
| 210 | 55 | 158 | 42 | 129 | 34 | 66 | 145 | 195 | 430 |

(CaCl₂, 75%, -30°C) Always use a tube when filled with water/salt.

TUBES AND VALVES

| Tube product code | Tube valve |
|-------------------|------------|
| T55105 | TR218A |

STUDDABLE

| Studdable |
|-----------|
| Yes |

NOKIAN TYRES TR FOREST 14.9-28 - T445409

| Product code | Size | LI/SS | Ply rating | TL/TT | Rim | Permitted rims | Width (mm) | Diameter (mm) | Loaded static radius (mm) | Rolling circumference (mm) | Pressure (kPa) | Max. inflation pressure (kPa) | Tread depth (mm) | Tread code | Tube product code |
|--------------|---------|--------------|------------|-------|------|---------------------|------------|---------------|---------------------------|----------------------------|----------------|-------------------------------|------------------|------------|-------------------|
| T445409 | 14.9-28 | 140A8 (137B) | 14 | TT | DW13 | DW12, W13, W12, W11 | 390 | 1353 | 635 | 4065 | 300 | 300 | 38 | R-1 | T55351 |

LOAD CAPACITY FOR TRACTOR, KG

| Pressure (kPa) | Forestry service (LT) | Road | | | | |
|----------------|-----------------------|------------|---------|---------------|---------|---------|
| | 10 km/h LT | 10 km/h LT | 20 km/h | 30 km/h 10 HT | 40 km/h | 50 km/h |
| 120 | 1895 | 2310 | 1895 | 1650 | 1540 | 1400 |
| 160 | 2305 | 2815 | 2305 | 2005 | 1875 | 1705 |
| 200 | 2540 | 3100 | 2540 | 2210 | 2065 | 1880 |
| 240 | 2705 | 3300 | 2705 | 2355 | 2200 | 2000 |
| 280 | 2970 | 3625 | 2970 | 2585 | 2415 | 2200 |
| 300 | 3075 | 3750 | 3075 | 2680 | 2500 | 2280 |

WATER AND SALT BALLASTING

| Tire volume 100% | | Water filling 75% | | Water/salt filling (75% / -30°C) | | | | Total weight increase | |
|------------------|---------|-------------------|---------|----------------------------------|---------|------|-----|-----------------------|-----|
| Litres | Gallons | Litres | Gallons | Water | | Salt | | kg | lbs |
| | | | | Litres | Gallons | kg | lbs | | |
| 240 | 63 | 180 | 48 | 148 | 39 | 75 | 166 | 223 | 492 |

(CaCl₂, 75%, -30°C) Always use a tube when filled with water/salt.

TUBES AND VALVES

| Tube product code | Tube valve |
|-------------------|------------|
| T55351 | TR218A |

NOKIAN TYRES TR FOREST 16.9-28 - T483301

| Product code | Size | LI/SS | Ply rating | TL/TT | Rim | Permitted rims | Width (mm) | Diameter (mm) | Loaded static radius (mm) | Rolling circumference (mm) | Pressure (kPa) | Max. inflation pressure (kPa) | Tread depth (mm) | Tread code | Tube product code |
|--------------|---------|--------------|------------|-------|------|------------------|------------|---------------|---------------------------|----------------------------|----------------|-------------------------------|------------------|------------|-------------------|
| T483301 | 16.9-28 | 145A8 (142B) | 14 | TT | DW15 | DW14, W15L, W14L | 440 | 1426 | 662 | 4291 | 270 | 270 | 42 | R-1 | T55370 |

LOAD CAPACITY FOR TRACTOR, KG

| Pressure (kPa) | Forestry service (LT) | | Road | | | |
|----------------|-----------------------|------------|---------|---------------|---------|---------|
| | 10 km/h LT | 10 km/h LT | 20 km/h | 30 km/h 10 HT | 40 km/h | 50 km/h |
| 120 | 2335 | 2850 | 2335 | 2035 | 1900 | 1730 |
| 160 | 2855 | 3480 | 2855 | 2480 | 2320 | 2110 |
| 200 | 3135 | 3825 | 3135 | 2730 | 2550 | 2320 |
| 240 | 3325 | 4060 | 3325 | 2895 | 2705 | 2460 |
| 270 | 3565 | 4350 | 3565 | 3120 | 2900 | 2640 |

WATER AND SALT BALLASTING

| Tire volume 100% | | Water filling 75% | | Water/salt filling (75% / -30°C) | | | | Total weight increase | |
|------------------|---------|-------------------|---------|----------------------------------|---------|------|-----|-----------------------|-----|
| | | | | Water | | Salt | | | |
| Litres | Gallons | Litres | Gallons | Litres | Gallons | kg | lbs | kg | lbs |
| 335 | 88 | 251 | 66 | 206 | 54 | 105 | 232 | 311 | 686 |

(CaCl₂, 75%, -30°C) Always use a tube when filled with water/salt.

TUBES AND VALVES

| Tube product code | Tube valve |
|-------------------|------------|
| T55370 | TR218A |

STUDDABLE

| Studdable | Number of studs |
|-----------|-----------------|
| Yes | 114 pcs |

NOKIAN TYRES TR FOREST 16.9-30 - T483810

| Product code | Size | LI/SS | Ply rating | TL/TT | Rim | Permitted rims | Width (mm) | Diameter (mm) | Loaded static radius (mm) | Rolling circumference (mm) | Pressure (kPa) | Max. inflation pressure (kPa) | Tread depth (mm) | Tread code | Tube product code |
|--------------|---------|--------------|------------|-------|------|------------------|------------|---------------|---------------------------|----------------------------|----------------|-------------------------------|------------------|------------|-------------------|
| T483810 | 16.9-30 | 144A8 (141B) | 14 | TT | DW15 | DW14, W15L, W14L | 434 | 1465 | 683 | 4361 | 260 | 260 | 45 | R-1 | T55371 |

LOAD CAPACITY FOR TRACTOR, KG

| Pressure (kPa) | Forestry service (LT) | Road | | | | |
|----------------|-----------------------|------------|---------|---------------|---------|---------|
| | 10 km/h LT | 10 km/h LT | 20 km/h | 30 km/h 10 HT | 40 km/h | 50 km/h |
| 160 | 2885 | 3480 | 2855 | 2480 | 2320 | 2110 |
| 200 | 3235 | 3945 | 3235 | 2815 | 2630 | 2395 |
| 240 | 3445 | 4200 | 3445 | 3000 | 2800 | 2550 |

WATER AND SALT BALLASTING

| Tire volume 100% | | Water filling 75% | | Water/salt filling (75% / -30°C) | | | | Total weight increase | |
|------------------|---------|-------------------|---------|----------------------------------|---------|------|-----|-----------------------|-----|
| Litres | Gallons | Litres | Gallons | Water | | Salt | | kg | lbs |
| | | | | Litres | Gallons | kg | lbs | | |
| 360 | 95 | 270 | 71 | 222 | 59 | 113 | 249 | 335 | 739 |

(CaCl2, 75%, -30°C) Always use a tube when filled with water/salt.

TUBES AND VALVES

| Tube product code | Tube valve |
|-------------------|------------|
| T55371 | TR218A |

STUDDABLE

| Studdable |
|-----------|
| Yes |

NOKIAN TYRES TR FOREST 16.9-34 - T484390

| Product code | Size | LI/SS | Ply rating | TL/TT | Rim | Permitted rims | Width (mm) | Diameter (mm) | Loaded static radius (mm) | Rolling circumference (mm) | Pressure (kPa) | Max. inflation pressure (kPa) | Tread depth (mm) | Tread code | Tube product code |
|--------------|---------|--------------|------------|-------|------|------------------|------------|---------------|---------------------------|----------------------------|----------------|-------------------------------|------------------|------------|-------------------|
| T484390 | 16.9-34 | 146A8 (143B) | 14 | TT | DW15 | DW14, W15L, W14L | 432 | 1562 | 742 | 4599 | 260 | 260 | 45 | R-1 | T55391 |

LOAD CAPACITY FOR TRACTOR, KG

| Pressure (kPa) | Forestry service (LT) | Road | | | | |
|----------------|-----------------------|------------|---------|---------------|---------|---------|
| | 10 km/h LT | 10 km/h LT | 20 km/h | 30 km/h 10 HT | 40 km/h | 50 km/h |
| 160 | 3175 | 3870 | 3175 | 2760 | 2580 | 2350 |
| 200 | 2470 | 4230 | 3470 | 3015 | 2820 | 2565 |
| 240 | 3690 | 4500 | 3690 | 3220 | 3000 | 2730 |

WATER AND SALT BALLASTING

| Tire volume 100% | | Water filling 75% | | Water/salt filling (75% / -30°C) | | | | Total weight increase | |
|------------------|---------|-------------------|---------|----------------------------------|---------|------|-----|-----------------------|-----|
| Litres | Gallons | Litres | Gallons | Water | | Salt | | kg | lbs |
| | | | | Litres | Gallons | kg | lbs | | |
| 390 | 103 | 293 | 77 | 240 | 63 | 122 | 270 | 362 | 798 |

(CaCl2, 75%, -30°C) Always use a tube when filled with water/salt.

TUBES AND VALVES

| Tube product code | Tube valve |
|-------------------|------------|
| T55391 | TR218A |

STUDDABLE

| Studdable | Number of studs |
|-----------|-----------------|
| Yes | 126 pcs |

NOKIAN TYRES TR FOREST 18.4-34 - T484420

| Product code | Size | LI/SS | Ply rating | TL/TT | Rim | Permitted rims | Width (mm) | Diameter (mm) | Loaded static radius (mm) | Rolling circumference (mm) | Pressure (kPa) | Max. inflation pressure (kPa) | Tread depth (mm) | Tread code | Tube product code |
|--------------|---------|--------------|------------|-------|------|------------------|------------|---------------|---------------------------|----------------------------|----------------|-------------------------------|------------------|------------|-------------------|
| T484420 | 18.4-34 | 154A8 (151B) | 14 | TT | DW16 | DW15, W16L, W15L | 478 | 1629 | 765 | 4825 | 260 | 260 | 48 | R-1 | T55391 |

LOAD CAPACITY FOR TRACTOR, KG

| Pressure (kPa) | Forestry service (LT) | Road | | | | |
|----------------|-----------------------|------------|---------|---------------|---------|---------|
| | 10 km/h LT | 10 km/h LT | 20 km/h | 30 km/h 10 HT | 40 km/h | 50 km/h |
| 120 | 3160 | 3855 | 3160 | 2750 | 2570 | 2340 |
| 160 | 3875 | 4725 | 3875 | 3370 | 3150 | 2865 |
| 200 | 4245 | 5175 | 4245 | 3690 | 3450 | 3140 |
| 250 | 4615 | 5625 | 4615 | 4020 | 3750 | 3420 |

WATER AND SALT BALLASTING

| Tire volume 100% | | Water filling 75% | | Water/salt filling (75% / -30°C) | | | | Total weight increase | |
|------------------|---------|-------------------|---------|----------------------------------|---------|------|-----|-----------------------|-----|
| Litres | Gallons | Litres | Gallons | Water | | Salt | | kg | lbs |
| | | | | Litres | Gallons | kg | lbs | | |
| 480 | 127 | 360 | 95 | 295 | 78 | 151 | 332 | 446 | 983 |

(CaCl2, 75%, -30°C) Always use a tube when filled with water/salt.

TUBES AND VALVES

| Tube product code | Tube valve |
|-------------------|------------|
| T55391 | TR218A |

STUDDABLE

| Studdable | Number of studs |
|-----------|-----------------|
| Yes | 126 pcs |

NOKIAN TYRES TR FOREST 18.4-38 - T485430

| Product code | Size | LI/SS | Ply rating | TL/TT | Rim | Permitted rims | Width (mm) | Diameter (mm) | Loaded static radius (mm) | Rolling circumference (mm) | Pressure (kPa) | Max. inflation pressure (kPa) | Tread depth (mm) | Tread code | Tube product code |
|--------------|---------|--------------|------------|-------|------|------------------|------------|---------------|---------------------------|----------------------------|----------------|-------------------------------|------------------|------------|-------------------|
| T485430 | 18.4-38 | 155A8 (152B) | 14 | TT | DW16 | DW15, W16L, W15L | 468 | 1738 | 819 | 5150 | 260 | 260 | 53 | R-1 | T55430 |

LOAD CAPACITY FOR TRACTOR, KG

| Pressure (kPa) | Forestry service (LT) | Road | | | | |
|----------------|-----------------------|------------|---------|---------------|---------|---------|
| | 10 km/h LT | 10 km/h LT | 20 km/h | 30 km/h 10 HT | 40 km/h | 50 km/h |
| 120 | 3225 | 3930 | 3225 | 2805 | 2620 | 2385 |
| 160 | 3935 | 4800 | 3935 | 3425 | 3200 | 2910 |
| 200 | 4325 | 5275 | 4325 | 3760 | 3515 | 3200 |
| 240 | 4550 | 5550 | 4550 | 3960 | 3700 | 3365 |
| 260 | 4765 | 5815 | 4765 | 4160 | 3875 | 3540 |

WATER AND SALT BALLASTING

| Tire volume 100% | | Water filling 75% | | Water/salt filling (75% / -30°C) | | | | Total weight increase | |
|------------------|---------|-------------------|---------|----------------------------------|---------|------|-----|-----------------------|------|
| Litres | Gallons | Litres | Gallons | Water | | Salt | | kg | lbs |
| | | | | Litres | Gallons | kg | lbs | | |
| 510 | 135 | 383 | 101 | 314 | 83 | 160 | 353 | 474 | 1045 |

(CaCl2, 75%, -30°C) Always use a tube when filled with water/salt.

TUBES AND VALVES

| Tube product code | Tube valve |
|-------------------|------------|
| T55430 | TR218A |

STUDDABLE

| Studdable | Number of studs |
|-----------|-----------------|
| Yes | 120 pcs |

NOKIAN TYRES TR FOREST 20.8-38 - T485450

| Product code | Size | LI/SS | Ply rating | TL/TT | Rim | Permitted rims | Width (mm) | Diameter (mm) | Loaded static radius (mm) | Rolling circumference (mm) | Pressure (kPa) | Max. inflation pressure (kPa) | Tread depth (mm) | Tread code |
|--------------|---------|--------------|------------|-------|------|------------------|------------|---------------|---------------------------|----------------------------|----------------|-------------------------------|------------------|------------|
| T485450 | 20.8-38 | 159A8 (156B) | 14 | TT | DW18 | DW16, W18L, W16L | 538 | 1825 | 853 | 5510 | 230 | 230 | 53 | R-1 |

LOAD CAPACITY FOR TRACTOR, KG

| Pressure (kPa) | Forestry service (LT) | Road | | | | |
|----------------|-----------------------|------------|---------|---------------|---------|---------|
| | 10 km/h LT | 10 km/h LT | 20 km/h | 30 km/h 10 HT | 40 km/h | 50 km/h |
| 120 | 3830 | 4675 | 3830 | 3335 | 3115 | 2835 |
| 160 | 4690 | 5725 | 4690 | 4080 | 3815 | 3470 |
| 200 | 5140 | 6270 | 5140 | 4475 | 4180 | 3805 |
| 230 | 5380 | 6565 | 5380 | 4700 | 4375 | 4000 |

WATER AND SALT BALLASTING

| Tire volume 100% | | Water filling 75% | | Water/salt filling (75% / -30°C) | | | | Total weight increase | |
|------------------|---------|-------------------|---------|----------------------------------|---------|------|-----|-----------------------|------|
| | | | | Water | | Salt | | | |
| Litres | Gallons | Litres | Gallons | Litres | Gallons | kg | lbs | kg | lbs |
| 685 | 181 | 514 | 136 | 422 | 111 | 215 | 474 | 637 | 1404 |

(CaCl2, 75%, -30°C) Always use a tube when filled with water/salt.

TUBES AND VALVES

| |
|-----------------------------|
| Tube valve TR218A |
|-----------------------------|

STUDDABLE

| | |
|-------------------------|-----------------------------------|
| Studdable Yes | Number of studs 120 pcs |
|-------------------------|-----------------------------------|

NOKIAN TYRES LOGGER KING LS-2 EXTREME

TIRE FOR FULL-TREE MACHINES, I. A. SKIDDERS AND WHEELED FELLER BUNCHERS

- Strong diagonal carcass with steel fortification layers covering the whole tread area and shoulders. Very thick layer of CCR rubber on top of steel fortification.
- More straight tread profile enables very wide contact to surface. Wide, open and aggressive tread design with “shovel” lug shape gives great traction and self-cleaning.
- In extreme versions there are added layers of carcass material and extra layers of steel in tread that give more load-bearing capacity and ultimate puncture resistance.

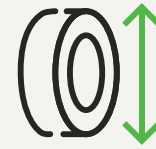

AVAILABLE SIZES

- - - T445660

NOKIAN TYRES LOGGER KING LS-2 EXTREME

ALL SIZES

| Product code | Size | LI/SS | Ply rating | Rim | Width (mm) | Pressure (kPa) | Max. inflation pressure (kPa) | Tread depth (mm) | Tread code | Tube product code |
|--------------|------|-------|------------|------|------------|----------------|-------------------------------|------------------|------------|-------------------|
| T445660 | - | 180A6 | 32 | DH27 | 775 | 380 | 380 | 67 | LS-2 | T55388 |

NOKIAN TYRES LOGGER KING LS-2 EXTREME - - T445660

| Product code | Size | LI/SS | Ply rating | Rim | Width (mm) | Pressure (kPa) | Max. inflation pressure (kPa) | Tread depth (mm) | Tread code | Tube product code |
|--------------|------|-------|------------|------|------------|----------------|-------------------------------|------------------|------------|-------------------|
| T445660 | - | 180A6 | 32 | DH27 | 775 | 380 | 380 | 67 | LS-2 | T55388 |

WATER AND SALT BALLASTING

| Tire volume 100% | | Water filling 75% | | Water/salt filling (75% / -30°C) | | | | Total weight increase | |
|------------------|---------|-------------------|---------|----------------------------------|---------|------|-----|-----------------------|------|
| | | | | Water | | Salt | | | |
| Litres | Gallons | Litres | Gallons | Litres | Gallons | kg | lbs | kg | lbs |
| 1040 | 275 | 780 | 206 | 640 | 169 | 326 | 719 | 966 | 2130 |

(CaCl₂, 75%, -30°C) Always use a tube when filled with water/salt.

TUBES AND VALVES

| | |
|------------------------------------|-----------------------------|
| Tube product code T55388 | Tube valve TR218A |
| Tubeless valve TR618A | |

NOKIAN TYRES FOREST KING T

FOR TRACTORS AND SKIDDERS USED IN FORESTRY, FOREST CLEARANCE OR ROAD CONSTRUCTION

- Strong and wide lugs enable good traction and tolerate high tractive forces.
- Steel fortifications together with strong diagonal construction give excellent puncture resistance.
- Stiff diagonal construction enables better stability.

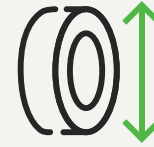

AVAILABLE SIZES

- 620/75-26 - T445365



NOKIAN TYRES FOREST KING T

ALL SIZES

| Product code | Size | L/SS | Reinforced code | TL/TT | Rim | Width (mm) | Loaded static radius (mm) | Rolling circumference (mm) | Pressure (kPa) | Max. inflation pressure (kPa) | Tread depth (mm) | Tread code | Tube product code |
|--------------|-----------|-------|-----------------|-------|-------|------------|---------------------------|----------------------------|----------------|-------------------------------|------------------|------------|-------------------|
| T445365 | 620/75-26 | 159A8 | SF | TT | DW20B | 627 | 723 | 4763 | 240 | 280 | 52 | LS-2 | T55102 |

NOKIAN TYRES FOREST KING T 620/75-26 - T445365

| Product code | Size | LI/SS | Reinforced code | TL/TT | Rim | Width (mm) | Loaded static radius (mm) | Rolling circumference (mm) | Pressure (kPa) | Max. inflation pressure (kPa) | Tread depth (mm) | Tread code | Tube product code |
|--------------|-----------|-------|-----------------|-------|-------|------------|---------------------------|----------------------------|----------------|-------------------------------|------------------|------------|-------------------|
| T445365 | 620/75-26 | 159A8 | SF | TT | DW20B | 627 | 723 | 4763 | 240 | 280 | 52 | LS-2 | T55102 |

WATER AND SALT BALLASTING

| Tire volume 100% | | Water filling 75% | | Water/salt filling (75% / -30°C) | | | | Total weight increase | |
|------------------|---------|-------------------|---------|----------------------------------|---------|------|-----|-----------------------|-----|
| | | | | Water | | Salt | | | |
| Litres | Gallons | Litres | Gallons | Litres | Gallons | kg | lbs | kg | lbs |
| 450 | 119 | 338 | 89 | 277 | 73 | 141 | 311 | 418 | 922 |

(CaCl₂, 75%, -30°C) Always use a tube when filled with water/salt.

TUBES AND VALVES

| Tube product code | Tube valve |
|-------------------|------------|
| T55102 | TR218A |



AGRICULTURAL AND CONTRACTING

Tractors and other agricultural machines are getting bigger and also faster in transition driving and other such situations. Consequently, low soil compaction and fuel costs are particular focus areas. In response to the quickly changing demands of farming, we are developing new radial products alongside the traditional cross-ply tires. Our extensive range of special agricultural tires provides farmers and the environment with controlled power and gentle efficiency throughout the year, every year.

nokian[®]
TYRES

AGRICULTURAL AND CONTRACTING TIRES

TRACTOR



27
**Nokian Tyres
TRI 2 Extreme
Steel**

TRAILER



35
**Nokian Tyres
CT**



38
**Nokian Tyres
ELS**

OTHER VEHICLES



43
**Nokian Tyres
Country King**

NOKIAN TYRES TRI 2 EXTREME STEEL

**MORE OPERATING HOURS, RELIABLE
GRIP ALL YEAR ROUND, DRIVING
COMFORT AND HIGH LOAD-BEARING
CAPACITY AT DEMANDING
CONTRACTING SITES**

- Excellent wear resistance against tear and wear in rough on and off the road conditions
- Steel belts give good puncture resistance to tread area
- Tread rubber designed for extreme conditions, requiring constant use of chains

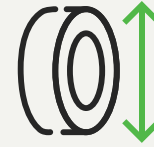

AVAILABLE SIZES

- 400/80R24 - T445530
- 440/80R24 - T445531
- 440/80R28 - T445532
- 480/80R34 - T445533
- 480/80R38 - T445534
- 540/80R38 - T445535

NOKIAN TYRES TRI 2 EXTREME STEEL

ALL SIZES

| Product code | Size | LI/SS | TL/TT | Rim | Permitted rims | Width (mm) | Diameter (mm) | Loaded static radius (mm) | Rolling circumference (mm) | SRI | Pressure (kPa) | Max. inflation pressure (kPa) | Tread depth (mm) | Tread code | Tube product code | M+S | Load capacity for constant load, kg | | | | | |
|--------------|-----------|--------------|-------|-------|-----------------------------|------------|---------------|---------------------------|----------------------------|-----|----------------|-------------------------------|------------------|------------|-------------------|-----|-------------------------------------|------|------|------|------|------|
| | | | | | | | | | | | | | | | | | Speed (km/h) | | | | | |
| | | | | | | | | | | | | | | | | | 40 | 45 | 50 | 55 | 60 | 65 |
| T445530 | 400/80R24 | 149A8 (144D) | TL | DW13 | W12, W13, W14L, DW12, DW14L | 403 | 1242 | 563 | 3751 | 600 | 320 | 320 | 27 | R-4 | T55112 | Yes | 3220 | 3135 | 3025 | 2940 | 2885 | 2800 |
| T445531 | 440/80R24 | 154A8 (149D) | TL | DW14L | W15L, DW15L | 443 | 1307 | 596 | 3946 | 625 | 320 | 320 | 28 | R-4 | T55112 | Yes | 3740 | 3640 | 3510 | 3415 | 3350 | 3250 |
| T445532 | 440/80R28 | 156A8 (151D) | TL | DW14L | W15L, W16L, DW15L, DW16L | 441 | 1410 | 643 | 4260 | 675 | 320 | 320 | 28 | R-4 | T55370 | Yes | 4085 | 3975 | 3835 | 3730 | 3655 | 3550 |
| T445533 | 480/80R34 | 164A8 (159D) | TL | DW15L | DW16L, DW18L | 482 | 1627 | 743 | 4932 | 775 | 320 | 320 | 29 | R-4 | T55391 | Yes | 5030 | 4900 | 4725 | 4595 | 4505 | 4375 |
| T445534 | 480/80R38 | 166A8 (161D) | TL | DW15L | DW16L, DW18L | 479 | 1729 | 793 | 5246 | 825 | 320 | 320 | 29 | R-4 | T55430 | Yes | 5320 | 5180 | 4995 | 4855 | 4765 | 4625 |
| T445535 | 540/80R38 | 172A8 (167D) | TL | DW18L | DW16L | 540 | 1826 | 829 | 5535 | 875 | 320 | 320 | 30 | R-4 | T55445 | Yes | 6440 | 6270 | 6050 | 5880 | 5770 | 5600 |

NOKIAN TYRES TRI 2 EXTREME STEEL 400/80R24 - T445530

| Product code | Size | LI/SS | TL/TT | Rim | Permitted rims | Width (mm) | Diameter (mm) | Loaded static radius (mm) | Rolling circumference (mm) | SRI | Pressure (kPa) | Max. inflation pressure (kPa) | Tread depth (mm) | Tread code | Tube product code | M+S |
|--------------|-----------|--------------|-------|------|-----------------------------|------------|---------------|---------------------------|----------------------------|-----|----------------|-------------------------------|------------------|------------|-------------------|-----|
| T445530 | 400/80R24 | 149A8 (144D) | TL | DW13 | W12, W13, W14L, DW12, DW14L | 403 | 1242 | 563 | 3751 | 600 | 320 | 320 | 27 | R-4 | T55112 | Yes |

LOAD CAPACITY FOR TRACTOR, KG

| Pressure (kPa) | Constant load | | | | | | | | | | | | | |
|----------------|---------------|--------|------------|---------|---------|---------|---------------|---------|---------|---------|---------|---------|---------|---------|
| | 0 km/h | 5 km/h | 10 km/h LT | 15 km/h | 20 km/h | 25 km/h | 30 km/h 10 HT | 35 km/h | 40 km/h | 45 km/h | 50 km/h | 55 km/h | 60 km/h | 65 km/h |
| 80 | 3390 | 2145 | 1850 | 1670 | 1620 | 1570 | 1540 | 1515 | 1480 | 1440 | 1390 | 1350 | 1325 | 1285 |
| 120 | 4355 | 2755 | 2375 | 2145 | 2080 | 2015 | 1980 | 1945 | 1900 | 1850 | 1780 | 1735 | 1700 | 1650 |
| 160 | 5280 | 3340 | 2880 | 2600 | 2520 | 2440 | 2400 | 2360 | 2300 | 2240 | 2160 | 2100 | 2060 | 2000 |
| 200 | 5755 | 3640 | 3140 | 2835 | 2745 | 2660 | 2615 | 2570 | 2505 | 2440 | 2355 | 2290 | 2245 | 2180 |
| 240 | 6230 | 3940 | 3400 | 3070 | 2975 | 2880 | 2830 | 2785 | 2715 | 2645 | 2550 | 2480 | 2430 | 2360 |
| 280 | 6800 | 4300 | 3710 | 3350 | 3245 | 3140 | 3090 | 3040 | 2960 | 2885 | 2780 | 2705 | 2650 | 2575 |
| 320 | 7390 | 4675 | 4030 | 3640 | 3530 | 3415 | 3360 | 3305 | 3220 | 3135 | 3025 | 2940 | 2885 | 2800 |

WATER AND SALT BALLASTING

| Tire volume 100% | | Water filling 75% | | Water/salt filling (75% / -30°C) | | | | Total weight increase | |
|------------------|---------|-------------------|---------|----------------------------------|---------|------|-----|-----------------------|-----|
| Litres | Gallons | Litres | Gallons | Water | | Salt | | kg | lbs |
| | | | | Litres | Gallons | kg | lbs | | |
| 265 | 70 | 199 | 53 | 163 | 43 | 83 | 183 | 246 | 542 |

(CaCl2, 75%, -30°C) Always use a tube when filled with water/salt.

TUBES AND VALVES

| | |
|------------------------------------|-----------------------------|
| Tube product code T55112 | Tube valve TR218A |
| Tubeless valve TR618A | |

STUDDABLE

| | |
|---------------------------------------|-----------------------------------|
| Studdable Yes | Number of studs 168 pcs |
| Marked stud positions on tread | |

NOKIAN TYRES TRI 2 EXTREME STEEL 440/80R24 - T445531

| Product code | Size | LI/SS | TL/TT | Rim | Permitted rims | Width (mm) | Diameter (mm) | Loaded static radius (mm) | Rolling circumference (mm) | SRI | Pressure (kPa) | Max. inflation pressure (kPa) | Tread depth (mm) | Tread code | Tube product code | M+S |
|--------------|-----------|--------------|-------|-------|----------------|------------|---------------|---------------------------|----------------------------|-----|----------------|-------------------------------|------------------|------------|-------------------|-----|
| T445531 | 440/80R24 | 154A8 (149D) | TL | DW14L | W15L, DW15L | 443 | 1307 | 596 | 3946 | 625 | 320 | 320 | 28 | R-4 | T55112 | Yes |

LOAD CAPACITY FOR TRACTOR, KG

| Pressure (kPa) | Constant load | | | | | | | | | | | | | |
|----------------|---------------|--------|------------|---------|---------|---------|---------------|---------|---------|---------|---------|---------|---------|---------|
| | 0 km/h | 5 km/h | 10 km/h LT | 15 km/h | 20 km/h | 25 km/h | 30 km/h 10 HT | 35 km/h | 40 km/h | 45 km/h | 50 km/h | 55 km/h | 60 km/h | 65 km/h |
| 80 | 3960 | 2505 | 2160 | 1950 | 1890 | 1830 | 1800 | 1770 | 1725 | 1680 | 1620 | 1575 | 1545 | 1500 |
| 120 | 5015 | 3175 | 2735 | 2470 | 2395 | 2320 | 2280 | 2240 | 2185 | 2130 | 2050 | 1995 | 1955 | 1900 |
| 160 | 6070 | 3840 | 3310 | 2990 | 2900 | 2805 | 2760 | 2715 | 2645 | 2575 | 2485 | 2415 | 2370 | 2300 |
| 200 | 6800 | 4300 | 3710 | 3350 | 3245 | 3140 | 3090 | 3040 | 2960 | 2885 | 2780 | 2705 | 2650 | 2575 |
| 240 | 7195 | 4550 | 3925 | 3545 | 3435 | 3325 | 3270 | 3215 | 3135 | 3050 | 2945 | 2860 | 2805 | 2725 |
| 280 | 7920 | 5010 | 4320 | 3900 | 3780 | 3660 | 3600 | 3540 | 3450 | 3360 | 3240 | 3150 | 3090 | 3000 |
| 320 | 8580 | 5430 | 4680 | 4225 | 4095 | 3965 | 3900 | 3835 | 3740 | 3640 | 3510 | 3415 | 3350 | 3250 |

WATER AND SALT BALLASTING

| Tire volume 100% | | Water filling 75% | | Water/salt filling (75% / -30°C) | | | | Total weight increase | |
|------------------|---------|-------------------|---------|----------------------------------|---------|------|-----|-----------------------|-----|
| Litres | Gallons | Litres | Gallons | Water | | Salt | | kg | lbs |
| | | | | Litres | Gallons | kg | lbs | | |
| 325 | 86 | 244 | 64 | 200 | 53 | 102 | 225 | 302 | 666 |

(CaCl2, 75%, -30°C) Always use a tube when filled with water/salt.

TUBES AND VALVES

| | |
|------------------------------------|-----------------------------|
| Tube product code T55112 | Tube valve TR218A |
| Tubeless valve TR618A | |

STUDDABLE

| | |
|---------------------------------------|-----------------------------------|
| Studdable Yes | Number of studs 168 pcs |
| Marked stud positions on tread | |

NOKIAN TYRES TRI 2 EXTREME STEEL 440/80R28 - T445532

| Product code | Size | LI/SS | TL/TT | Rim | Permitted rims | Width (mm) | Diameter (mm) | Loaded static radius (mm) | Rolling circumference (mm) | SRI | Pressure (kPa) | Max. inflation pressure (kPa) | Tread depth (mm) | Tread code | Tube product code | M+S |
|--------------|-----------|--------------|-------|-------|--------------------------|------------|---------------|---------------------------|----------------------------|-----|----------------|-------------------------------|------------------|------------|-------------------|-----|
| T445532 | 440/80R28 | 156A8 (151D) | TL | DW14L | W15L, W16L, DW15L, DW16L | 441 | 1410 | 643 | 4260 | 675 | 320 | 320 | 28 | R-4 | T55370 | Yes |

LOAD CAPACITY FOR TRACTOR, KG

| Pressure (kPa) | Constant load | | | | | | | | | | | | | |
|----------------|---------------|--------|------------|---------|---------|---------|---------------|---------|---------|---------|---------|---------|---------|---------|
| | 0 km/h | 5 km/h | 10 km/h LT | 15 km/h | 20 km/h | 25 km/h | 30 km/h 10 HT | 35 km/h | 40 km/h | 45 km/h | 50 km/h | 55 km/h | 60 km/h | 65 km/h |
| 80 | 4225 | 2670 | 2305 | 2080 | 2015 | 1950 | 1920 | 1890 | 1840 | 1790 | 1730 | 1680 | 1650 | 1600 |
| 120 | 5280 | 3340 | 2880 | 2600 | 2520 | 2440 | 2400 | 2360 | 2300 | 2240 | 2160 | 2100 | 2060 | 2000 |
| 160 | 6600 | 4175 | 3600 | 3250 | 3150 | 3050 | 3000 | 2950 | 2875 | 2800 | 2700 | 2625 | 2575 | 2500 |
| 200 | 7195 | 4550 | 3925 | 3545 | 3435 | 3325 | 3270 | 3215 | 3135 | 3050 | 2945 | 2860 | 2805 | 2725 |
| 240 | 7655 | 4845 | 4175 | 3770 | 3655 | 3540 | 3480 | 3420 | 3335 | 3250 | 3130 | 3045 | 2985 | 2900 |
| 280 | 8315 | 5260 | 4535 | 4095 | 3970 | 3845 | 3780 | 3715 | 3625 | 3530 | 3400 | 3310 | 3245 | 3150 |
| 320 | 9370 | 5930 | 5110 | 4615 | 4475 | 4330 | 4260 | 4190 | 4085 | 3975 | 3835 | 3730 | 3655 | 3550 |

WATER AND SALT BALLASTING

| Tire volume 100% | | Water filling 75% | | Water/salt filling (75% / -30°C) | | | | Total weight increase | |
|------------------|---------|-------------------|---------|----------------------------------|---------|------|-----|-----------------------|-----|
| Litres | Gallons | Litres | Gallons | Water | | Salt | | kg | lbs |
| | | | | Litres | Gallons | kg | lbs | | |
| 365 | 96 | 274 | 72 | 225 | 59 | 115 | 252 | 340 | 750 |

(CaCl₂, 75%, -30°C) Always use a tube when filled with water/salt.

TUBES AND VALVES

| | |
|------------------------------------|-----------------------------|
| Tube product code T55370 | Tube valve TR218A |
| Tubeless valve TR618A | |

STUDDABLE

| | |
|---------------------------------------|-----------------------------------|
| Studdable Yes | Number of studs 168 pcs |
| Marked stud positions on tread | |

NOKIAN TYRES TRI 2 EXTREME STEEL 480/80R34 - T445533

| Product code | Size | LI/SS | TL/TT | Rim | Permitted rims | Width (mm) | Diameter (mm) | Loaded static radius (mm) | Rolling circumference (mm) | SRI | Pressure (kPa) | Max. inflation pressure (kPa) | Tread depth (mm) | Tread code | Tube product code | M+S |
|--------------|-----------|--------------|-------|-------|----------------|------------|---------------|---------------------------|----------------------------|-----|----------------|-------------------------------|------------------|------------|-------------------|-----|
| T445533 | 480/80R34 | 164A8 (159D) | TL | DW15L | DW16L, DW18L | 482 | 1627 | 743 | 4932 | 775 | 320 | 320 | 29 | R-4 | T55391 | Yes |

LOAD CAPACITY FOR TRACTOR, KG

| Pressure (kPa) | Constant load | | | | | | | | | | | | | |
|----------------|---------------|--------|------------|---------|---------|---------|---------------|---------|---------|---------|---------|---------|---------|---------|
| | 0 km/h | 5 km/h | 10 km/h LT | 15 km/h | 20 km/h | 25 km/h | 30 km/h 10 HT | 35 km/h | 40 km/h | 45 km/h | 50 km/h | 55 km/h | 60 km/h | 65 km/h |
| 80 | 5150 | 3255 | 2810 | 2535 | 2455 | 2380 | 2340 | 2300 | 2245 | 2185 | 2105 | 2050 | 2010 | 1950 |
| 120 | 6600 | 4175 | 3600 | 3250 | 3150 | 3050 | 3000 | 2950 | 2875 | 2800 | 2700 | 2625 | 2575 | 2500 |
| 160 | 8120 | 5135 | 4430 | 4000 | 3875 | 3750 | 3690 | 3630 | 3535 | 3445 | 3320 | 3230 | 3165 | 3075 |
| 200 | 9110 | 5760 | 4970 | 4485 | 4345 | 4210 | 4140 | 4070 | 3970 | 3865 | 3725 | 3625 | 3555 | 3450 |
| 240 | 9635 | 6095 | 5255 | 4745 | 4600 | 4455 | 4380 | 4305 | 4200 | 4090 | 3940 | 3835 | 3760 | 3650 |
| 280 | 10560 | 6680 | 5760 | 5200 | 5040 | 4880 | 4800 | 4720 | 4600 | 4480 | 4320 | 4200 | 4120 | 4000 |
| 320 | 11550 | 7305 | 6300 | 5690 | 5515 | 5340 | 5250 | 5165 | 5030 | 4900 | 4725 | 4595 | 4505 | 4375 |

WATER AND SALT BALLASTING

| Tire volume 100% | | Water filling 75% | | Water/salt filling (75% / -30°C) | | | | Total weight increase | |
|------------------|---------|-------------------|---------|----------------------------------|---------|------|-----|-----------------------|------|
| Litres | Gallons | Litres | Gallons | Water | | Salt | | kg | lbs |
| | | | | Litres | Gallons | kg | lbs | | |
| 515 | 136 | 386 | 102 | 317 | 84 | 162 | 356 | 479 | 1056 |

(CaCl2, 75%, -30°C) Always use a tube when filled with water/salt.

TUBES AND VALVES

| | |
|------------------------------------|-----------------------------|
| Tube product code T55391 | Tube valve TR218A |
| Tubeless valve TR618A | |

STUDDABLE

| | |
|---------------------------------------|-----------------------------------|
| Studdable Yes | Number of studs 192 pcs |
| Marked stud positions on tread | |

NOKIAN TYRES TRI 2 EXTREME STEEL 480/80R38 - T445534

| Product code | Size | LI/SS | TL/TT | Rim | Permitted rims | Width (mm) | Diameter (mm) | Loaded static radius (mm) | Rolling circumference (mm) | SRI | Pressure (kPa) | Max. inflation pressure (kPa) | Tread depth (mm) | Tread code | Tube product code | M+S |
|--------------|-----------|--------------|-------|-------|----------------|------------|---------------|---------------------------|----------------------------|-----|----------------|-------------------------------|------------------|------------|-------------------|-----|
| T445534 | 480/80R38 | 166A8 (161D) | TL | DW15L | DW16L, DW18L | 479 | 1729 | 793 | 5246 | 825 | 320 | 320 | 29 | R-4 | T55430 | Yes |

LOAD CAPACITY FOR TRACTOR, KG

| Pressure (kPa) | Constant load | | | | | | | | | | | | | |
|----------------|---------------|--------|------------|---------|---------|---------|---------------|---------|---------|---------|---------|---------|---------|---------|
| | 0 km/h | 5 km/h | 10 km/h LT | 15 km/h | 20 km/h | 25 km/h | 30 km/h 10 HT | 35 km/h | 40 km/h | 45 km/h | 50 km/h | 55 km/h | 60 km/h | 65 km/h |
| 80 | 5440 | 3440 | 2965 | 2680 | 2595 | 2515 | 2470 | 2430 | 2370 | 2305 | 2225 | 2165 | 2120 | 2060 |
| 120 | 6995 | 4425 | 3815 | 3445 | 3340 | 3235 | 3180 | 3125 | 3050 | 2970 | 2860 | 2785 | 2730 | 2650 |
| 160 | 8580 | 5430 | 4680 | 4225 | 4095 | 3965 | 3900 | 3835 | 3740 | 3640 | 3510 | 3415 | 3350 | 3250 |
| 200 | 9370 | 5930 | 5110 | 4615 | 4475 | 4330 | 4260 | 4190 | 4085 | 3975 | 3835 | 3730 | 3655 | 3550 |
| 240 | 10230 | 6470 | 5580 | 5040 | 4885 | 4730 | 4650 | 4575 | 4455 | 4340 | 4185 | 4070 | 3990 | 3875 |
| 280 | 10890 | 6890 | 5940 | 5365 | 5200 | 5035 | 4950 | 4870 | 4745 | 4620 | 4455 | 4330 | 4250 | 4125 |
| 320 | 12210 | 7725 | 6660 | 6015 | 5830 | 5645 | 5550 | 5460 | 5320 | 5180 | 4995 | 4855 | 4765 | 4625 |

WATER AND SALT BALLASTING

| Tire volume 100% | | Water filling 75% | | Water/salt filling (75% / -30°C) | | | | Total weight increase | |
|------------------|---------|-------------------|---------|----------------------------------|---------|------|-----|-----------------------|------|
| Litres | Gallons | Litres | Gallons | Water | | Salt | | kg | lbs |
| | | | | Litres | Gallons | kg | lbs | | |
| 560 | 148 | 420 | 111 | 345 | 91 | 176 | 387 | 521 | 1149 |

(CaCl2, 75%, -30°C) Always use a tube when filled with water/salt.

TUBES AND VALVES

| | |
|------------------------------------|-----------------------------|
| Tube product code T55430 | Tube valve TR218A |
| Tubeless valve TR618A | |

STUDDABLE

| | |
|---------------------------------------|-----------------------------------|
| Studdable Yes | Number of studs 192 pcs |
| Marked stud positions on tread | |

NOKIAN TYRES TRI 2 EXTREME STEEL 540/80R38 - T445535

| Product code | Size | LI/SS | TL/TT | Rim | Permitted rims | Width (mm) | Diameter (mm) | Loaded static radius (mm) | Rolling circumference (mm) | SRI | Pressure (kPa) | Max. inflation pressure (kPa) | Tread depth (mm) | Tread code | Tube product code | M+S |
|--------------|-----------|--------------|-------|-------|----------------|------------|---------------|---------------------------|----------------------------|-----|----------------|-------------------------------|------------------|------------|-------------------|-----|
| T445535 | 540/80R38 | 172A8 (167D) | TL | DW18L | DW16L | 540 | 1826 | 829 | 5535 | 875 | 320 | 320 | 30 | R-4 | T55445 | Yes |

LOAD CAPACITY FOR TRACTOR, KG

| Pressure (kPa) | Constant load | | | | | | | | | | | | | |
|----------------|---------------|--------|------------|---------|---------|---------|---------------|---------|---------|---------|---------|---------|---------|---------|
| | 0 km/h | 5 km/h | 10 km/h LT | 15 km/h | 20 km/h | 25 km/h | 30 km/h 10 HT | 35 km/h | 40 km/h | 45 km/h | 50 km/h | 55 km/h | 60 km/h | 65 km/h |
| 80 | 6600 | 4175 | 3600 | 3250 | 3150 | 3050 | 3000 | 2950 | 2875 | 2800 | 2700 | 2625 | 2575 | 2500 |
| 120 | 8315 | 5260 | 4535 | 4095 | 3970 | 3845 | 3780 | 3715 | 3625 | 3530 | 3400 | 3310 | 3245 | 3150 |
| 160 | 10230 | 6470 | 5580 | 5040 | 4885 | 4730 | 4650 | 4575 | 4455 | 4340 | 4185 | 4070 | 3990 | 3875 |
| 200 | 11220 | 7100 | 6120 | 5525 | 5355 | 5185 | 5100 | 5015 | 4890 | 4760 | 4590 | 4465 | 4380 | 4250 |
| 240 | 12210 | 7725 | 6660 | 6015 | 5830 | 5645 | 5550 | 5460 | 5320 | 5180 | 4995 | 4855 | 4765 | 4625 |
| 280 | 13200 | 8350 | 7200 | 6500 | 6300 | 6100 | 6000 | 5900 | 5750 | 5600 | 5400 | 5250 | 5150 | 5000 |
| 320 | 14785 | 9350 | 8065 | 7280 | 7055 | 6830 | 6720 | 6610 | 6440 | 6270 | 6050 | 5880 | 5770 | 5600 |

WATER AND SALT BALLASTING

| Tire volume 100% | | Water filling 75% | | Water/salt filling (75% / -30°C) | | | | Total weight increase | |
|------------------|---------|-------------------|---------|----------------------------------|---------|------|-----|-----------------------|------|
| Litres | Gallons | Litres | Gallons | Water | | Salt | | kg | lbs |
| | | | | Litres | Gallons | kg | lbs | | |
| 740 | 195 | 555 | 147 | 455 | 120 | 232 | 512 | 687 | 1515 |

(CaCl2, 75%, -30°C) Always use a tube when filled with water/salt.

TUBES AND VALVES

| | |
|------------------------------------|-----------------------------|
| Tube product code T55445 | Tube valve TR218A |
| Tubeless valve TR618A | |

STUDDABLE

| | |
|---------------------------------------|-----------------------------------|
| Studdable Yes | Number of studs 192 pcs |
| Marked stud positions on tread | |

NOKIAN TYRES CT

EARTHMOVING GRADE RADIAL FLOTATION TIRE FOR HEAVY TRANSPORTATIONS

- Exceptional mileage provided by dense and thick heavy-duty block pattern.
- Special puncture damage resistance with three layers of steel reinforcements in the tread area.
- Stable load-bearing provided by the extra-strength multilayer construction.



2026-05-05

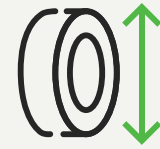

AVAILABLE SIZES

- 600/55R26.5 - T445628

NOKIAN TYRES CT

ALL SIZES

| Product code | Size | LI/SS | TL/TT | Rim | Width (mm) | Diameter (mm) | Loaded static radius (mm) | Rolling circumference (mm) | SRI | Pressure (kPa) | Max. inflation pressure (kPa) | Tread depth (mm) | Tube product code | Load capacity for mixed, kg | | | | | |
|--------------|-------------|-------|-------|---------|------------|---------------|---------------------------|----------------------------|-----|----------------|-------------------------------|------------------|-------------------|-----------------------------|------|------|------|------|------|
| | | | | | | | | | | | | | | Speed (km/h) | | | | | |
| | | | | | | | | | | | | | | 40 | 45 | 50 | 55 | 60 | 65 |
| T445628 | 600/55R26.5 | 169D | TL | AG20.00 | 601 | 1333 | 603 | 4067 | 625 | 500 | 500 | 24 | T55098 | 7890 | 7480 | 7020 | 6610 | 6205 | 5800 |

NOKIAN TYRES CT 600/55R26.5 - T445628

| Product code | Size | LI/SS | TL/TT | Rim | Width (mm) | Diameter (mm) | Loaded static radius (mm) | Rolling circumference (mm) | SRI | Pressure (kPa) | Max. inflation pressure (kPa) | Tread depth (mm) | Tube product code |
|--------------|-------------|-------|-------|---------|------------|---------------|---------------------------|----------------------------|-----|----------------|-------------------------------|------------------|-------------------|
| T445628 | 600/55R26.5 | 169D | TL | AG20.00 | 601 | 1333 | 603 | 4067 | 625 | 500 | 500 | 24 | T55098 |

LOAD CAPACITY FOR TRAILER, KG

| Pressure (kPa) | Mixed | | | | | | | | | | | |
|----------------|---------|---------|---------|---------|---------|---------|---------|---------|---------|---------|---------|---------|
| | 10 km/h | 15 km/h | 20 km/h | 25 km/h | 30 km/h | 35 km/h | 40 km/h | 45 km/h | 50 km/h | 55 km/h | 60 km/h | 65 km/h |
| 80 | 2970 | 2855 | 2725 | 2605 | 2490 | 2375 | 2245 | 2130 | 1995 | 1880 | 1765 | 1650 |
| 120 | 3815 | 3670 | 3500 | 3350 | 3200 | 3055 | 2885 | 2735 | 2565 | 2415 | 2270 | 2120 |
| 160 | 4635 | 4455 | 4250 | 4070 | 3890 | 3710 | 3500 | 3320 | 3115 | 2935 | 2755 | 2575 |
| 200 | 5220 | 5015 | 4785 | 4580 | 4380 | 4175 | 3945 | 3740 | 3510 | 3305 | 3105 | 2900 |
| 240 | 6030 | 5795 | 5530 | 5295 | 5060 | 4825 | 4555 | 4320 | 4055 | 3820 | 3585 | 3350 |
| 280 | 6975 | 6705 | 6395 | 6125 | 5850 | 5580 | 5270 | 5000 | 4690 | 4420 | 4145 | 3875 |
| 320 | 7650 | 7355 | 7015 | 6715 | 6420 | 6120 | 5780 | 5485 | 5145 | 4845 | 4550 | 4250 |
| 360 | 8325 | 8000 | 7630 | 7310 | 6985 | 6660 | 6290 | 5965 | 5595 | 5275 | 4950 | 4625 |
| 400 | 9270 | 8910 | 8500 | 8135 | 7775 | 7415 | 7005 | 6645 | 6230 | 5870 | 5510 | 5150 |
| 450 | 9810 | 9430 | 8995 | 8610 | 8230 | 7850 | 7410 | 7030 | 6595 | 6215 | 5830 | 5450 |
| 500 | 10440 | 10035 | 9570 | 9165 | 8760 | 8350 | 7890 | 7480 | 7020 | 6610 | 6205 | 5800 |

WATER AND SALT BALLASTING

| Tire volume 100% | | Water filling 75% | | Water/salt filling (75% / -30°C) | | | | Total weight increase | |
|------------------|---------|-------------------|---------|----------------------------------|---------|------|-----|-----------------------|-----|
| Litres | Gallons | Litres | Gallons | Water | | Salt | | kg | lbs |
| | | | | Litres | Gallons | kg | lbs | | |
| 475 | 125 | 356 | 94 | 292 | 77 | 149 | 329 | 441 | 972 |

(CaCl2, 75%, -30°C) Always use a tube when filled with water/salt.

TUBES AND VALVES

| | |
|------------------------------------|-----------------------------|
| Tube product code T55098 | Tube valve TR218A |
| Tubeless valve TR618A | |

NOKIAN TYRES ELS

RADIAL TRACTION FLOTATION TIRE FOR AGRICULTURAL OPERATIONS IN CHALLENGING SOIL CONDITIONS

- Reliable grip due to open, well cleaning traction pattern.
- Soil and crop damage prevention with large pattern contact and rounded shoulder design.
- Directional stability and controlled handling performance with high strength steel belted construction.



2026-05-05

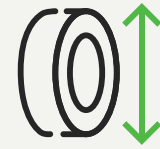

AVAILABLE SIZES

- 710/45R22.5 - T445348
- 700/50R26.5 - T445227
- 600/55R26.5 - T445146

NOKIAN TYRES ELS

ALL SIZES

| Product code | Size | LI/SS | TL/TT | Rim | Permitted rims | Width (mm) | Diameter (mm) | Loaded static radius (mm) | Rolling circumference (mm) | SRI | Pressure (kPa) | Max. inflation pressure (kPa) | Tread depth (mm) | Load capacity for mixed, kg | | | | | |
|--------------|-------------|-------|-------|---------|----------------|------------|---------------|---------------------------|----------------------------|-----|----------------|-------------------------------|------------------|-----------------------------|------|------|------|------|------|
| | | | | | | | | | | | | | | Speed (km/h) | | | | | |
| | | | | | | | | | | | | | | 40 | 45 | 50 | 55 | 60 | 65 |
| T445348 | 710/45R22.5 | 156D | TL | AG24.00 | 24.00 | 712 | 1212 | 582 | 3654 | 575 | 280 | 280 | 20 | 5270 | 5000 | 4690 | 4420 | 4145 | 3875 |
| T445146 | 600/55R26.5 | 158D | TL | AG20.00 | 20.00 | 625 | 1333 | 603 | 4040 | 625 | 320 | 320 | 22 | 5780 | 5485 | 5145 | 4845 | 4550 | 4250 |
| T445227 | 700/50R26.5 | 161D | TL | AG24.00 | 20.00, 24.00 | 728 | 1373 | 625 | 4160 | 650 | 280 | 280 | 22 | | | | | | |

NOKIAN TYRES ELS 710/45R22.5 - T445348

| Product code | Size | LI/SS | TL/TT | Rim | Permitted rims | Width (mm) | Diameter (mm) | Loaded static radius (mm) | Rolling circumference (mm) | SRI | Pressure (kPa) | Max. inflation pressure (kPa) | Tread depth (mm) |
|--------------|-------------|-------|-------|---------|----------------|------------|---------------|---------------------------|----------------------------|-----|----------------|-------------------------------|------------------|
| T445348 | 710/45R22.5 | 156D | TL | AG24.00 | 24.00 | 712 | 1212 | 582 | 3654 | 575 | 280 | 280 | 20 |

LOAD CAPACITY FOR TRAILER, KG

| Pressure (kPa) | Mixed | | | | | | | | | | | |
|----------------|---------|---------|---------|---------|---------|---------|---------|---------|---------|---------|---------|---------|
| | 10 km/h | 15 km/h | 20 km/h | 25 km/h | 30 km/h | 35 km/h | 40 km/h | 45 km/h | 50 km/h | 55 km/h | 60 km/h | 65 km/h |
| 80 | 2970 | 2855 | 2725 | 2605 | 2490 | 2375 | 2245 | 2130 | 1995 | 1880 | 1765 | 1650 |
| 120 | 3815 | 3670 | 3500 | 3350 | 3200 | 3055 | 2885 | 2735 | 2565 | 2415 | 2270 | 2120 |
| 160 | 4635 | 4455 | 4250 | 4070 | 3890 | 3710 | 3500 | 3320 | 3115 | 2935 | 2755 | 2575 |
| 200 | 5400 | 5190 | 4950 | 4740 | 4530 | 4320 | 4080 | 3870 | 3630 | 3420 | 3210 | 3000 |
| 240 | 6210 | 5970 | 5695 | 5450 | 5210 | 4970 | 4690 | 4450 | 4175 | 3935 | 3690 | 3450 |
| 280 | 6975 | 6705 | 6395 | 6125 | 5850 | 5580 | 5270 | 5000 | 4690 | 4420 | 4145 | 3875 |

WATER AND SALT BALLASTING

| Tire volume 100% | | Water filling 75% | | Water/salt filling (75% / -30°C) | | | | Total weight increase | |
|------------------|---------|-------------------|---------|----------------------------------|---------|------|-----|-----------------------|-----|
| Litres | Gallons | Litres | Gallons | Water | | Salt | | kg | lbs |
| | | | | Litres | Gallons | kg | lbs | | |
| 0 | 0 | 0 | 0 | 0 | 0 | 0 | 0 | 0 | 0 |

(CaCl₂, 75%, -30°C) Always use a tube when filled with water/salt.

NOKIAN TYRES ELS 600/55R26.5 - T445146

| Product code | Size | LI/SS | TL/TT | Rim | Permitted rims | Width (mm) | Diameter (mm) | Loaded static radius (mm) | Rolling circumference (mm) | SRI | Pressure (kPa) | Max. inflation pressure (kPa) | Tread depth (mm) |
|--------------|-------------|-------|-------|---------|----------------|------------|---------------|---------------------------|----------------------------|-----|----------------|-------------------------------|------------------|
| T445146 | 600/55R26.5 | 158D | TL | AG20.00 | 20.00 | 625 | 1333 | 603 | 4040 | 625 | 320 | 320 | 22 |

LOAD CAPACITY FOR TRAILER, KG

| Pressure (kPa) | Mixed | | | | | | | | | | | |
|----------------|---------|---------|---------|---------|---------|---------|---------|---------|---------|---------|---------|---------|
| | 10 km/h | 15 km/h | 20 km/h | 25 km/h | 30 km/h | 35 km/h | 40 km/h | 45 km/h | 50 km/h | 55 km/h | 60 km/h | 65 km/h |
| 80 | 2970 | 2855 | 2725 | 2605 | 2490 | 2375 | 2245 | 2130 | 1995 | 1880 | 1765 | 1650 |
| 120 | 3815 | 3670 | 3500 | 3350 | 3200 | 3055 | 2885 | 2735 | 2565 | 2415 | 2270 | 2120 |
| 160 | 4635 | 4455 | 4250 | 4070 | 3890 | 3710 | 3500 | 3320 | 3115 | 2935 | 2755 | 2575 |
| 200 | 5220 | 5015 | 4785 | 4580 | 4380 | 4175 | 3945 | 3740 | 3510 | 3305 | 3105 | 2900 |
| 240 | 6030 | 5795 | 5530 | 5295 | 5060 | 4825 | 4555 | 4320 | 4055 | 3820 | 3585 | 3350 |
| 280 | 6975 | 6705 | 6395 | 6125 | 5850 | 5580 | 5270 | 5000 | 4690 | 4420 | 4145 | 3875 |
| 320 | 7650 | 7355 | 7015 | 6715 | 6420 | 6120 | 5780 | 5485 | 5145 | 4845 | 4550 | 4250 |

WATER AND SALT BALLASTING

| Tire volume 100% | | Water filling 75% | | Water/salt filling (75% / -30°C) | | | | Total weight increase | |
|------------------|---------|-------------------|---------|----------------------------------|---------|------|-----|-----------------------|-----|
| Litres | Gallons | Litres | Gallons | Water | | Salt | | kg | lbs |
| | | | | Litres | Gallons | kg | lbs | | |
| 0 | 0 | 0 | 0 | 0 | 0 | 0 | 0 | 0 | 0 |

(CaCl2, 75%, -30°C) Always use a tube when filled with water/salt.

NOKIAN TYRES ELS 700/50R26.5 - T445227

| Product code | Size | LI/SS | TL/TT | Rim | Permitted rims | Width (mm) | Diameter (mm) | Loaded static radius (mm) | Rolling circumference (mm) | SRI | Pressure (kPa) | Max. inflation pressure (kPa) | Tread depth (mm) |
|--------------|-------------|-------|-------|---------|----------------|------------|---------------|---------------------------|----------------------------|-----|----------------|-------------------------------|------------------|
| T445227 | 700/50R26.5 | 161D | TL | AG24.00 | 20.00, 24.00 | 728 | 1373 | 625 | 4160 | 650 | 280 | 280 | 22 |

WATER AND SALT BALLASTING

| Tire volume 100% | | Water filling 75% | | Water/salt filling (75% / -30°C) | | | | Total weight increase | |
|------------------|---------|-------------------|---------|----------------------------------|---------|------|-----|-----------------------|-----|
| | | | | Water | | Salt | | | |
| Litres | Gallons | Litres | Gallons | Litres | Gallons | kg | lbs | kg | lbs |
| 0 | 0 | 0 | 0 | 0 | 0 | 0 | 0 | 0 | 0 |

(CaCl₂, 75%, -30°C) Always use a tube when filled with water/salt.

NOKIAN TYRES COUNTRY KING

EFFICIENT RADIAL FLOTATION TIRE FOR AGRICULTURAL TRANSPORTATIONS ON ROAD AND FIELD

- Durability and low rolling resistance due to high positive pattern ratio and special tread compound.
- Soil and crop damage prevention with large pattern contact and rounded shoulder design.
- Directional stability and controlled handling performance with high strength steel belted construction.

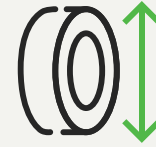

AVAILABLE SIZES

- 560/60R22.5 - T445560
- 580/65R22.5 - T445648
- 600/50R22.5 - T445558

NOKIAN TYRES COUNTRY KING

ALL SIZES

| Product code | Size | LI/SS | TL/TT | Rim | Width (mm) | Diameter (mm) | Loaded static radius (mm) | Rolling circumference (mm) | SRI | Pressure (kPa) | Max. inflation pressure (kPa) | Tread depth (mm) | Tube product code | Load capacity for mixed, kg | | | | | |
|--------------|-------------|-------|-------|---------|------------|---------------|---------------------------|----------------------------|-----|----------------|-------------------------------|------------------|-------------------|-----------------------------|------|------|------|------|------|
| | | | | | | | | | | | | | | Speed (km/h) | | | | | |
| | | | | | | | | | | | | | | 40 | 45 | 50 | 55 | 60 | 65 |
| T445560 | 560/60R22.5 | 162D | TL | | 571 | 1244 | | | 600 | 400 | | | | | | | | | |
| T445648 | 580/65R22.5 | 166D | TL | | 555 | 1326 | | | 625 | 400 | | | | | | | | | |
| T445558 | 600/50R22.5 | 160D | TL | AG20.00 | 608 | 1165 | 532 | 3569 | 550 | 400 | 600 | 18 | T55089 | 5950 | 5645 | 5295 | 4990 | 4680 | 4375 |

NOKIAN TYRES COUNTRY KING 560/60R22.5 - T445560

| Product code | Size | LI/SS | TL/TT | Width (mm) | Diameter (mm) | SRI | Pressure (kPa) |
|--------------|-------------|-------|-------|------------|---------------|-----|----------------|
| T445560 | 560/60R22.5 | 162D | TL | 571 | 1244 | 600 | 400 |

WATER AND SALT BALLASTING

| Tire volume 100% | | Water filling 75% | | Water/salt filling (75% / -30°C) | | | | Total weight increase | |
|------------------|---------|-------------------|---------|----------------------------------|---------|------|-----|-----------------------|-----|
| | | | | Water | | Salt | | | |
| Litres | Gallons | Litres | Gallons | Litres | Gallons | kg | lbs | kg | lbs |
| 0 | 0 | 0 | 0 | 0 | 0 | 0 | 0 | 0 | 0 |

(CaCl2, 75%, -30°C) Always use a tube when filled with water/salt.

NOKIAN TYRES COUNTRY KING 580/65R22.5 - T445648

| Product code | Size | LI/SS | TL/TT | Width (mm) | Diameter (mm) | SRI | Pressure (kPa) |
|--------------|-------------|-------|-------|------------|---------------|-----|----------------|
| T445648 | 580/65R22.5 | 166D | TL | 555 | 1326 | 625 | 400 |

WATER AND SALT BALLASTING

| Tire volume 100% | | Water filling 75% | | Water/salt filling (75% / -30°C) | | | | Total weight increase | |
|------------------|---------|-------------------|---------|----------------------------------|---------|------|-----|-----------------------|-----|
| Litres | Gallons | Litres | Gallons | Water | | Salt | | kg | lbs |
| Litres | Gallons | Litres | Gallons | Litres | Gallons | kg | lbs | kg | lbs |
| 0 | 0 | 0 | 0 | 0 | 0 | 0 | 0 | 0 | 0 |

(CaCl2, 75%, -30°C) Always use a tube when filled with water/salt.

NOKIAN TYRES COUNTRY KING 600/50R22.5 - T445558

| Product code | Size | LI/SS | TL/TT | Rim | Width (mm) | Diameter (mm) | Loaded static radius (mm) | Rolling circumference (mm) | SRI | Pressure (kPa) | Max. inflation pressure (kPa) | Tread depth (mm) | Tube product code |
|--------------|-------------|-------|-------|---------|------------|---------------|---------------------------|----------------------------|-----|----------------|-------------------------------|------------------|-------------------|
| T445558 | 600/50R22.5 | 160D | TL | AG20.00 | 608 | 1165 | 532 | 3569 | 550 | 400 | 600 | 18 | T55089 |

LOAD CAPACITY, KG

| Pressure (kPa) | Mixed | | | | | | | | | | | |
|----------------|---------|---------|---------|---------|---------|---------|---------|---------|---------|---------|---------|---------|
| | 10 km/h | 15 km/h | 20 km/h | 25 km/h | 30 km/h | 35 km/h | 40 km/h | 45 km/h | 50 km/h | 55 km/h | 60 km/h | 65 km/h |
| 80 | 2520 | 2420 | 2310 | 2210 | 2115 | 2015 | 1905 | 1805 | 1695 | 1595 | 1500 | 1400 |
| 120 | 3240 | 3115 | 2970 | 2845 | 2720 | 2590 | 2450 | 2320 | 2180 | 2050 | 1925 | 1800 |
| 160 | 3925 | 3770 | 3595 | 3445 | 3290 | 3140 | 2965 | 2810 | 2640 | 2485 | 2335 | 2180 |
| 200 | 4500 | 4325 | 4125 | 3950 | 3775 | 3600 | 3400 | 3225 | 3025 | 2850 | 2675 | 2500 |
| 240 | 5220 | 5015 | 4785 | 4580 | 4380 | 4175 | 3945 | 3740 | 3510 | 3305 | 3105 | 2900 |
| 280 | 5850 | 5625 | 5365 | 5135 | 4910 | 4680 | 4420 | 4195 | 3935 | 3705 | 3480 | 3250 |
| 320 | 6570 | 6315 | 6025 | 5765 | 5510 | 5255 | 4965 | 4710 | 4415 | 4160 | 3905 | 3650 |
| 360 | 7200 | 6920 | 6600 | 6320 | 6040 | 5760 | 5440 | 5160 | 4840 | 4560 | 4280 | 4000 |
| 400 | 7875 | 7570 | 7220 | 6915 | 6605 | 6300 | 5950 | 5645 | 5295 | 4990 | 4680 | 4375 |

WATER AND SALT BALLASTING

| Tire volume 100% | | Water filling 75% | | Water/salt filling (75% / -30°C) | | | | Total weight increase | |
|------------------|---------|-------------------|---------|----------------------------------|---------|------|-----|-----------------------|-----|
| Litres | Gallons | Litres | Gallons | Water | | Salt | | kg | lbs |
| | | | | Litres | Gallons | kg | lbs | | |
| 370 | 98 | 278 | 73 | 228 | 60 | 116 | 256 | 344 | 758 |

(CaCl₂, 75%, -30°C) Always use a tube when filled with water/salt.

TUBES AND VALVES

| | |
|------------------------------------|-----------------------------|
| Tube product code T55089 | Tube valve TR218A |
| Tubeless valve TR618A | |



UNDERGROUND MINING

The world of mining tires is rough. Uneven surfaces with sharp edges require tires that offer extreme durability and high load-bearing capacity. Particularly for mining tires, we have developed the CCR (cut and crack resistant) rubber compound that enhances demanding transportation and mining tasks. The sturdy and stable tires for mine loaders, drill rigs and various other mining equipment guarantee a long service life.

nokian[®]
TYRES

UNDERGROUND MINING TIRES

DRILL RIGS AND OTHER MINING MACHINES



50

**Nokian Tyres
Armor Gard
MINE**



54

**Nokian Tyres
Mine E-3**

NOKIAN TYRES ARMOR GARD MINE

TOP-CLASS TIRE FOR MINING MACHINERY, LIFT TRUCKS AND EXCAVATORS

- Precise and stable driving response
- Record-breaking mileage
- Tread design with excellent traction

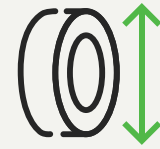

AVAILABLE SIZES

- 9.00-20 - T445562
- 12.00-20 - T445449



NOKIAN TYRES ARMOR GARD MINE

ALL SIZES

| Product code | Size | LI/SS | Ply rating | TL/TT | Rim | Permitted rims | Width (mm) | Diameter (mm) | Loaded static radius (mm) | Rolling circumference (mm) | Pressure (kPa) | Max. inflation pressure (kPa) | Tread depth (mm) | Tread code | Tube product code | Min. dual spacing (mm) | Load capacity, kg | | | | | |
|--------------|----------|-------|------------|-------|-----|----------------|------------|---------------|---------------------------|----------------------------|----------------|-------------------------------|------------------|------------|-------------------|------------------------|-------------------|------|------|------|------|------|
| | | | | | | | | | | | | | | | | | Speed (km/h) | | | | | |
| | | | | | | | | | | | | | | | | | 0 | 1 | 5 | 10 | 20 | 25 |
| T445562 | 9.00-20 | 160A5 | 16 | TT | 7.0 | 7.5 | 278 | 1038 | 480 | 3123 | 1000 | 1000 | 20 | E-2 | T52520 | 311 | 6795 | 5850 | 5850 | 5850 | 4500 | 4500 |
| T445449 | 12.00-20 | 176A5 | 20 | TT | 8.5 | 9.0 | 330 | 1140 | 521 | 3431 | 1000 | 1000 | 25 | | T52810 | 378 | 10720 | 9230 | 9230 | 9230 | 7100 | 7100 |

NOKIAN TYRES ARMOR GARD MINE 9.00-20 - T445562

| Product code | Size | LI/SS | Ply rating | TL/TT | Rim | Permitted rims | Width (mm) | Diameter (mm) | Loaded static radius (mm) | Rolling circumference (mm) | Pressure (kPa) | Max. inflation pressure (kPa) | Tread depth (mm) | Tread code | Tube product code | Min. dual spacing (mm) |
|--------------|---------|-------|------------|-------|-----|----------------|------------|---------------|---------------------------|----------------------------|----------------|-------------------------------|------------------|------------|-------------------|------------------------|
| T445562 | 9.00-20 | 160A5 | 16 | TT | 7.0 | 7.5 | 278 | 1038 | 480 | 3123 | 1000 | 1000 | 20 | E-2 | T52520 | 311 |

LOAD CAPACITY FOR DRILL RIGS AND OTHER MINING MACHINES, KG

| Pressure (kPa) | 0 km/h | 1 km/h | 5 km/h | 10 km/h | 20 km/h | 25 km/h |
|----------------|--------|--------|--------|---------|---------|---------|
| 800 | 5965 | 5135 | 5135 | 5135 | 3950 | 3950 |
| 825 | 6070 | 5225 | 5225 | 5225 | 4020 | 4020 |
| 850 | 6180 | 5320 | 5320 | 5320 | 4090 | 4090 |
| 875 | 6285 | 5410 | 5410 | 5410 | 4160 | 4160 |
| 900 | 6390 | 5500 | 5500 | 5500 | 4230 | 4230 |
| 925 | 6490 | 5590 | 5590 | 5590 | 4300 | 4300 |
| 950 | 6595 | 5675 | 5675 | 5675 | 4365 | 4365 |
| 975 | 6695 | 5765 | 5765 | 5765 | 4435 | 4435 |
| 1000 | 6795 | 5850 | 5850 | 5850 | 4500 | 4500 |

WATER AND SALT BALLASTING

| Tire volume 100% | | Water filling 75% | | Water/salt filling (75% / -30°C) | | | | Total weight increase | |
|------------------|---------|-------------------|---------|----------------------------------|---------|------|-----|-----------------------|-----|
| Litres | Gallons | Litres | Gallons | Water | | Salt | | kg | lbs |
| | | | | Litres | Gallons | kg | lbs | | |
| 90 | 24 | 68 | 18 | 55 | 15 | 28 | 62 | 83 | 183 |

(CaCl₂, 75%, -30°C) Always use a tube when filled with water/salt.

TUBES AND VALVES

| Tube product code | Tube valve |
|-------------------|------------|
| T52520 | TR175 |

NOKIAN TYRES ARMOR GARD MINE 12.00-20 - T445449

| Product code | Size | LI/SS | Ply rating | TL/TT | Rim | Permitted rims | Width (mm) | Diameter (mm) | Loaded static radius (mm) | Rolling circumference (mm) | Pressure (kPa) | Max. inflation pressure (kPa) | Tread depth (mm) | Tube product code | Min. dual spacing (mm) |
|--------------|----------|-------|------------|-------|-----|----------------|------------|---------------|---------------------------|----------------------------|----------------|-------------------------------|------------------|-------------------|------------------------|
| T445449 | 12.00-20 | 176A5 | 20 | TT | 8.5 | 9.0 | 330 | 1140 | 521 | 3431 | 1000 | 1000 | 25 | T52810 | 378 |

LOAD CAPACITY FOR DRILL RIGS AND OTHER MINING MACHINES, KG

| Pressure (kPa) | 0 km/h | 1 km/h | 5 km/h | 10 km/h | 20 km/h | 25 km/h |
|----------------|--------|--------|--------|---------|---------|---------|
| 800 | 9410 | 8100 | 8100 | 8100 | 6230 | 6230 |
| 825 | 9580 | 8250 | 8250 | 8250 | 6345 | 6345 |
| 850 | 9750 | 8395 | 8395 | 8395 | 6455 | 6455 |
| 875 | 9915 | 8535 | 8535 | 8535 | 6565 | 6565 |
| 900 | 10080 | 8680 | 8680 | 8680 | 6675 | 6675 |
| 925 | 10245 | 8820 | 8820 | 8820 | 6785 | 6785 |
| 950 | 10405 | 8955 | 8955 | 8955 | 6890 | 6890 |
| 975 | 10565 | 9095 | 9095 | 9095 | 6995 | 6995 |
| 1000 | 10720 | 9230 | 9230 | 9230 | 7100 | 7100 |

WATER AND SALT BALLASTING

| Tire volume 100% | | Water filling 75% | | Water/salt filling (75% / -30°C) | | | | Total weight increase | |
|------------------|---------|-------------------|---------|----------------------------------|---------|------|-----|-----------------------|-----|
| Litres | Gallons | Litres | Gallons | Water | | Salt | | kg | lbs |
| | | | | Litres | Gallons | kg | lbs | | |
| 145 | 38 | 109 | 29 | 89 | 24 | 45 | 100 | 134 | 295 |

(CaCl₂, 75%, -30°C) Always use a tube when filled with water/salt.

TUBES AND VALVES

| Tube product code | Tube valve |
|-------------------|------------|
| T52810 | V3.02.16 |

NOKIAN TYRES MINE E-3

STURDINESS AND RELIABILITY FOR DRILL RIGS

- Sturdy special tire for drill rigs and other mining machines
- Durable tread ensures long lifespan
- Stable driving response

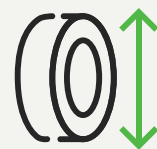

AVAILABLE SIZES

- 14.00-24 - T445456

NOKIAN TYRES MINE E-3

ALL SIZES

| Product code | Size | LI/SS | Ply rating | TL/TT | Rim | Permitted rims | Width (mm) | Diameter (mm) | Loaded static radius (mm) | Rolling circumference (mm) | Pressure (kPa) | Max. inflation pressure (kPa) | Tread depth (mm) | Tread code | Tube product code | Min. dual spacing (mm) | Load capacity, kg | | | | | |
|--------------|----------|-------|------------|-------|------|------------------|------------|---------------|---------------------------|----------------------------|----------------|-------------------------------|------------------|------------|-------------------|------------------------|-------------------|-------|-------|-------|------|------|
| | | | | | | | | | | | | | | | | | Speed (km/h) | | | | | |
| | | | | | | | | | | | | | | | | | 0 | 1 | 5 | 10 | 20 | 25 |
| T445456 | 14.00-24 | 186A5 | 28 | TL | 10.0 | 10.00WA, 10.00VA | 391 | 1372 | 634 | 4134 | 1000 | 1000 | 29 | E-3 | T55767 | 450 | 14250 | 12350 | 12350 | 12350 | 9500 | 9500 |

NOKIAN TYRES MINE E-3 14.00-24 - T445456

| Product code | Size | LI/SS | Ply rating | TL/TT | Rim | Permitted rims | Width (mm) | Diameter (mm) | Loaded static radius (mm) | Rolling circumference (mm) | Pressure (kPa) | Max. inflation pressure (kPa) | Tread depth (mm) | Tread code | Tube product code | Min. dual spacing (mm) |
|--------------|----------|-------|------------|-------|------|------------------|------------|---------------|---------------------------|----------------------------|----------------|-------------------------------|------------------|------------|-------------------|------------------------|
| T445456 | 14.00-24 | 186A5 | 28 | TL | 10.0 | 10.00WA, 10.00VA | 391 | 1372 | 634 | 4134 | 1000 | 1000 | 29 | E-3 | T55767 | 450 |

LOAD CAPACITY FOR DRILL RIGS AND OTHER MINING MACHINES, KG

| Pressure (kPa) | 0 km/h | 1 km/h | 5 km/h | 10 km/h | 20 km/h | 25 km/h |
|----------------|--------|--------|--------|---------|---------|---------|
| 700 | 11565 | 10025 | 10025 | 10025 | 7710 | 7710 |
| 725 | 11805 | 10230 | 10230 | 10230 | 7870 | 7870 |
| 750 | 12045 | 10435 | 10435 | 10435 | 8030 | 8030 |
| 775 | 12275 | 10640 | 10640 | 10640 | 8185 | 8185 |
| 800 | 12505 | 10840 | 10840 | 10840 | 8335 | 8335 |
| 825 | 12735 | 11035 | 11035 | 11035 | 8490 | 8490 |
| 850 | 12960 | 11230 | 11230 | 11230 | 8640 | 8640 |
| 875 | 13180 | 11420 | 11420 | 11420 | 8785 | 8785 |
| 900 | 13400 | 11610 | 11610 | 11610 | 8930 | 8930 |
| 925 | 13615 | 11800 | 11800 | 11800 | 9075 | 9075 |
| 950 | 13830 | 11985 | 11985 | 11985 | 9220 | 9220 |
| 975 | 14040 | 12170 | 12170 | 12170 | 9360 | 9360 |
| 1000 | 14250 | 12350 | 12350 | 12350 | 9500 | 9500 |

WATER AND SALT BALLASTING

| Tire volume 100% | | Water filling 75% | | Water/salt filling (75% / -30°C) | | | | Total weight increase | |
|------------------|---------|-------------------|---------|----------------------------------|---------|------|-----|-----------------------|-----|
| Litres | Gallons | Litres | Gallons | Water | | Salt | | kg | lbs |
| | | | | Litres | Gallons | kg | lbs | | |
| 230 | 61 | 173 | 46 | 142 | 37 | 72 | 159 | 214 | 472 |

(CaCl2, 75%, -30°C) Always use a tube when filled with water/salt.

TUBES AND VALVES

| | |
|------------------------------------|------------------------------|
| Tube product code T55767 | Tube valve TR1175A |
| Tubeless valve TR650 | |



— PORTS AND TERMINALS

The relentless lifting, moving and transporting of heavy loads, requires besides high load bearing capacity absolute precision and stability from the tires. The much praised wear resistance of our container and material handling tires is based on thorough material and structure development.

nokian[®]
TYRES

PORTS AND TERMINALS TIRES

REACH STACKER



59

Nokian Tyres
HTS E-4

FORK LIFT



64

Nokian Tyres
HTS E-3

RTG



67

Nokian Tyres
RTG

OTHER VEHICLES



70

Nokian Tyres
Nordman
Harbour



73

Nokian Tyres
HTS L-4S

NOKIAN TYRES HTS E-4

STABLE CONTAINER HANDLING

- A stable special tire for harbour and terminal equipment; also suitable for sawmills and timberyards
- Durable cross-ply structure
- Excellent driving result, well suited for retreading

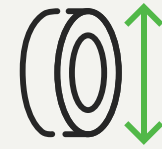

AVAILABLE SIZES

- 16.00-25 - T488431
- 18.00-25 - T488530
- 18.00-33 - T445514

NOKIAN TYRES HTS E-4

ALL SIZES

| Product code | Size | LI/SS | Ply rating | TL/TT | Rim | Permitted rims | Width (mm) | Diameter (mm) | Loaded static radius (mm) | Rolling circumference (mm) | Pressure (kPa) | Max. inflation pressure (kPa) | Tread depth (mm) | Tread code | Tube product code | Min. dual spacing (mm) | Load capacity for load wheel, kg | | | | | |
|--------------|----------|-------|------------|-------|-----------|-------------------------|------------|---------------|---------------------------|----------------------------|----------------|-------------------------------|------------------|------------|-------------------|------------------------|----------------------------------|-------|-------|-------|-------|-------|
| | | | | | | | | | | | | | | | | | Speed (km/h) | | | | | |
| | | | | | | | | | | | | | | | | | 0 | 1 | 5 | 10 | 20 | 25 |
| T488431 | 16.00-25 | 195A5 | 36 | TL | 11.25/2.0 | 11.25/2.0 IF, 13.00/2.0 | 450 | 1530 | 694 | 4618 | 1000 | 1000 | 52.5 | E-4 | T55810 | 518 | 18225 | 15795 | 15795 | 15795 | 15795 | 15795 |
| T488530 | 18.00-25 | 207A5 | 40 | TL | 13.00/2.5 | 13.00/2.5, 15.00/2.5 | 535 | 1673 | 772 | 4935 | 1000 | 1000 | 56 | E-4 | T55831 | 598 | | | | | | |
| T445514 | 18.00-33 | 214A5 | 40 | TL | 13.00/2.5 | 13.00/2.5 IF | 503 | 1869 | 853 | 5554 | 1000 | 1000 | 67 | E-4 | | 598 | | | | | | |

NOKIAN TYRES HTS E-4 16.00-25 - T488431

| Product code | Size | LI/SS | Ply rating | TL/TT | Rim | Permitted rims | Width (mm) | Diameter (mm) | Loaded static radius (mm) | Rolling circumference (mm) | Pressure (kPa) | Max. inflation pressure (kPa) | Tread depth (mm) | Tread code | Tube product code | Min. dual spacing (mm) |
|--------------|----------|-------|------------|-------|-----------|-------------------------|------------|---------------|---------------------------|----------------------------|----------------|-------------------------------|------------------|------------|-------------------|------------------------|
| T488431 | 16.00-25 | 195A5 | 36 | TL | 11.25/2.0 | 11.25/2.0 IF, 13.00/2.0 | 450 | 1530 | 694 | 4618 | 1000 | 1000 | 52.5 | E-4 | T55810 | 518 |

LOAD CAPACITY FOR REACH STACKER, KG

| Pressure (kPa) | Load wheel | | | | | | Steer wheel | | | | | |
|----------------|------------|--------|--------|---------|---------|---------|-------------|--------|--------|---------|---------|---------|
| | 0 km/h | 1 km/h | 5 km/h | 10 km/h | 20 km/h | 25 km/h | 0 km/h | 1 km/h | 5 km/h | 10 km/h | 20 km/h | 25 km/h |
| 1000 | 18225 | 15795 | 15795 | 15795 | 15795 | 15795 | 14580 | 12760 | 12760 | 12760 | 12150 | 12150 |

WATER AND SALT BALLASTING

| Tire volume 100% | | Water filling 75% | | Water/salt filling (75% / -30°C) | | | | Total weight increase | |
|------------------|---------|-------------------|---------|----------------------------------|---------|------|-----|-----------------------|-----|
| Litres | Gallons | Litres | Gallons | Water | | Salt | | kg | lbs |
| | | | | Litres | Gallons | kg | lbs | | |
| 355 | 94 | 266 | 70 | 218 | 58 | 111 | 246 | 329 | 725 |

(CaCl₂, 75%, -30°C) Always use a tube when filled with water/salt.

TUBES AND VALVES

| | |
|------------------------------------|-------------------------------|
| Tube product code T55810 | Tube valve TR J1175 |
| Tubeless valve TR650 | |

NOKIAN TYRES HTS E-4 18.00-25 - T488530

| Product code | Size | LI/SS | Ply rating | TL/TT | Rim | Permitted rims | Width (mm) | Diameter (mm) | Loaded static radius (mm) | Rolling circumference (mm) | Pressure (kPa) | Max. inflation pressure (kPa) | Tread depth (mm) | Tread code | Tube product code | Min. dual spacing (mm) |
|--------------|----------|-------|------------|-------|-----------|----------------------|------------|---------------|---------------------------|----------------------------|----------------|-------------------------------|------------------|------------|-------------------|------------------------|
| T488530 | 18.00-25 | 207A5 | 40 | TL | 13.00/2.5 | 13.00/2.5, 15.00/2.5 | 535 | 1673 | 772 | 4935 | 1000 | 1000 | 56 | E-4 | T55831 | 598 |

WATER AND SALT BALLASTING

| Tire volume 100% | | Water filling 75% | | Water/salt filling (75% / -30°C) | | | | Total weight increase | |
|------------------|---------|-------------------|---------|----------------------------------|---------|------|-----|-----------------------|-----|
| Litres | Gallons | Litres | Gallons | Water | | Salt | | kg | lbs |
| | | | | Litres | Gallons | kg | lbs | | |
| 470 | 124 | 353 | 93 | 289 | 76 | 147 | 325 | 436 | 961 |

(CaCl2, 75%, -30°C) Always use a tube when filled with water/salt.

TUBES AND VALVES

| | |
|------------------------------------|-------------------------------|
| Tube product code T55831 | Tube valve TR J1175 |
| Tubeless valve TR650 | |

NOKIAN TYRES HTS E-4 18.00-33 - T445514

| Product code | Size | LI/SS | Ply rating | TL/TT | Rim | Permitted rims | Width (mm) | Diameter (mm) | Loaded static radius (mm) | Rolling circumference (mm) | Pressure (kPa) | Max. inflation pressure (kPa) | Tread depth (mm) | Tread code | Min. dual spacing (mm) |
|--------------|----------|-------|------------|-------|-----------|----------------|------------|---------------|---------------------------|----------------------------|----------------|-------------------------------|------------------|------------|------------------------|
| T445514 | 18.00-33 | 214A5 | 40 | TL | 13.00/2.5 | 13.00/2.5 IF | 503 | 1869 | 853 | 5554 | 1000 | 1000 | 67 | E-4 | 598 |

WATER AND SALT BALLASTING

| Tire volume 100% | | Water filling 75% | | Water/salt filling (75% / -30°C) | | | | Total weight increase | |
|------------------|---------|-------------------|---------|----------------------------------|---------|------|-----|-----------------------|------|
| Litres | Gallons | Litres | Gallons | Water | | Salt | | kg | lbs |
| | | | | Litres | Gallons | kg | lbs | | |
| 520 | 137 | 390 | 103 | 320 | 85 | 163 | 360 | 483 | 1065 |

(CaCl₂, 75%, -30°C) Always use a tube when filled with water/salt.

TUBES AND VALVES

| |
|--------------------------------|
| Tubeless valve TR650 |
|--------------------------------|

NOKIAN TYRES HTS E-3

STABLE CONTAINER HANDLING

- A stable special tire for harbour and terminal equipment; also suitable for sawmills and timberyards
- Durable cross-ply structure
- Excellent driving result, well suited for retreading

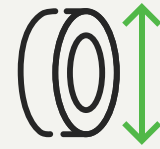

AVAILABLE SIZES

- 14.00-24 - T488311

NOKIAN TYRES HTS E-3

ALL SIZES

| Product code | Size | LI/SS | Ply rating | TL/TT | Rim | Permitted rims | Width (mm) | Diameter (mm) | Loaded static radius (mm) | Rolling circumference (mm) | Pressure (kPa) | Max. inflation pressure (kPa) | Tread depth (mm) | Tread code | Tube product code | Min. dual spacing (mm) | Load capacity for load wheel, kg | | | | | |
|--------------|----------|-------|------------|-------|--------|------------------|------------|---------------|---------------------------|----------------------------|----------------|-------------------------------|------------------|------------|-------------------|------------------------|----------------------------------|-------|-------|-------|-------|-------|
| | | | | | | | | | | | | | | | | | Speed (km/h) | | | | | |
| | | | | | | | | | | | | | | | | | 0 | 1 | 5 | 10 | 20 | 25 |
| T488311 | 14.00-24 | 186A5 | 28 | TL | 10.00W | 10.00WA, 10.00VA | 393 | 1375 | 624 | 4115 | 1000 | 1000 | 29 | E-3 | T55767 | 450 | 14250 | 12350 | 12350 | 12350 | 12350 | 12350 |

NOKIAN TYRES HTS E-3 14.00-24 - T488311

| Product code | Size | LI/SS | Ply rating | TL/TT | Rim | Permitted rims | Width (mm) | Diameter (mm) | Loaded static radius (mm) | Rolling circumference (mm) | Pressure (kPa) | Max. inflation pressure (kPa) | Tread depth (mm) | Tread code | Tube product code | Min. dual spacing (mm) |
|--------------|----------|-------|------------|-------|--------|------------------|------------|---------------|---------------------------|----------------------------|----------------|-------------------------------|------------------|------------|-------------------|------------------------|
| T488311 | 14.00-24 | 186A5 | 28 | TL | 10.00W | 10.00WA, 10.00VA | 393 | 1375 | 624 | 4115 | 1000 | 1000 | 29 | E-3 | T55767 | 450 |

LOAD CAPACITY FOR FORK LIFT, KG

| Pressure (kPa) | Load wheel | | | | | | Steer wheel | | | | | |
|----------------|------------|--------|--------|---------|---------|---------|-------------|--------|--------|---------|---------|---------|
| | 0 km/h | 1 km/h | 5 km/h | 10 km/h | 20 km/h | 25 km/h | 0 km/h | 1 km/h | 5 km/h | 10 km/h | 20 km/h | 25 km/h |
| 900 | 13400 | 11610 | 11610 | 11610 | 11610 | 11610 | 10720 | 9380 | 9380 | 9380 | 8930 | 8930 |
| 925 | 13615 | 11800 | 11800 | 11800 | 11800 | 11800 | 10890 | 9530 | 9530 | 9530 | 9075 | 9075 |
| 950 | 13830 | 11985 | 11985 | 11985 | 11985 | 11985 | 11065 | 9680 | 9680 | 9680 | 9220 | 9220 |
| 975 | 14040 | 12170 | 12170 | 12170 | 12170 | 12170 | 11230 | 9830 | 9830 | 9830 | 9360 | 9360 |
| 1000 | 14250 | 12350 | 12350 | 12350 | 12350 | 12350 | 11400 | 9975 | 9975 | 9975 | 9500 | 9500 |

WATER AND SALT BALLASTING

| Tire volume 100% | | Water filling 75% | | Water/salt filling (75% / -30°C) | | | | Total weight increase | |
|------------------|---------|-------------------|---------|----------------------------------|---------|------|-----|-----------------------|-----|
| Litres | Gallons | Litres | Gallons | Water | | Salt | | kg | lbs |
| | | | | Litres | Gallons | kg | lbs | | |
| 230 | 61 | 173 | 46 | 142 | 37 | 72 | 159 | 214 | 472 |

(CaCl₂, 75%, -30°C) Always use a tube when filled with water/salt.

TUBES AND VALVES

| | |
|------------------------------------|------------------------------|
| Tube product code T55767 | Tube valve TR1175A |
| Tubeless valve TR650 | |

NOKIAN TYRES RTG

MORE AGILITY AND DURABILITY FOR THE RTG CRANES

- Tread pattern and tire shape that allow the wheel to turn more easily.
- Low heat build-up slows down tire wear and gives it more operating hours.
- Special rubber compound optimized for harbour use.

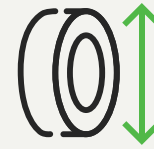

AVAILABLE SIZES

- 18.00-25 - T445468

NOKIAN TYRES RTG

ALL SIZES

| Product code | Size | LI/SS | Ply rating | TL/TT | Rim | Permitted rims | Width (mm) | Diameter (mm) | Loaded static radius (mm) | Rolling circumference (mm) | Pressure (kPa) | Max. inflation pressure (kPa) | Tread depth (mm) | Tread code | Tube product code | Min. dual spacing (mm) | Load capacity, kg | | | | |
|--------------|----------|-------|------------|-------|-----------|-------------------------|------------|---------------|---------------------------|----------------------------|----------------|-------------------------------|------------------|------------|-------------------|------------------------|-------------------|-------|-------|-------|-------|
| | | | | | | | | | | | | | | | | | Speed (km/h) | | | | |
| | | | | | | | | | | | | | | | | | 0 | 5 | 10 | 20 | 25 |
| T445468 | 18.00-25 | 207A5 | 40 | TL | 13.00/2.5 | 13.00/2.5 IF, 15.00/2.5 | 534 | 1663 | 738 | 4976 | 1000 | 1000 | 31.5 | E-3 | T55831 | 598 | 26250 | 22750 | 22750 | 22750 | 22750 |

NOKIAN TYRES RTG 18.00-25 - T445468

| Product code | Size | LI/SS | Ply rating | TL/TT | Rim | Permitted rims | Width (mm) | Diameter (mm) | Loaded static radius (mm) | Rolling circumference (mm) | Pressure (kPa) | Max. inflation pressure (kPa) | Tread depth (mm) | Tread code | Tube product code | Min. dual spacing (mm) |
|--------------|----------|-------|------------|-------|-----------|-------------------------|------------|---------------|---------------------------|----------------------------|----------------|-------------------------------|------------------|------------|-------------------|------------------------|
| T445468 | 18.00-25 | 207A5 | 40 | TL | 13.00/2.5 | 13.00/2.5 IF, 15.00/2.5 | 534 | 1663 | 738 | 4976 | 1000 | 1000 | 31.5 | E-3 | T55831 | 598 |

LOAD CAPACITY FOR RTG, KG

| Pressure (kPa) | 0 km/h | 5 km/h | 10 km/h | 20 km/h | 25 km/h |
|----------------|--------|--------|---------|---------|---------|
| 1000 | 26250 | 22750 | 22750 | 22750 | 22750 |

WATER AND SALT BALLASTING

| Tire volume 100% | | Water filling 75% | | Water/salt filling (75% / -30°C) | | | | Total weight increase | |
|------------------|---------|-------------------|---------|----------------------------------|---------|------|-----|-----------------------|-----|
| Litres | Gallons | Litres | Gallons | Water | | Salt | | kg | lbs |
| | | | | Litres | Gallons | kg | lbs | | |
| 470 | 124 | 353 | 93 | 289 | 76 | 147 | 325 | 436 | 961 |

(CaCl₂, 75%, -30°C) Always use a tube when filled with water/salt.

TUBES AND VALVES

| | |
|------------------------------------|-------------------------------|
| Tube product code T55831 | Tube valve TR J1175 |
| Tubeless valve TR650 | |

NOKIAN TYRES NORDMAN HARBOUR

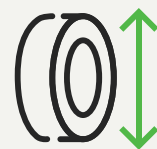

AVAILABLE SIZES

- -- T845489

NOKIAN TYRES NORDMAN HARBOUR

ALL SIZES

| Product code | Size | LI/SS | Ply rating | Diameter (mm) | Tread code |
|--------------|------|-------|------------|---------------|------------|
| T845489 | - | ONA | 40 | 1673 | E-4 |

NOKIAN TYRES NORDMAN HARBOUR - - T845489

| Product code | Size | LI/SS | Ply rating | Diameter (mm) | Tread code |
|--------------|------|-------|------------|---------------|------------|
| T845489 | - | ONA | 40 | 1673 | E-4 |

WATER AND SALT BALLASTING

| Tire volume 100% | | Water filling 75% | | Water/salt filling (75% / -30°C) | | | | Total weight increase | |
|------------------|---------|-------------------|---------|----------------------------------|---------|------|-----|-----------------------|-----|
| | | | | Water | | Salt | | | |
| Litres | Gallons | Litres | Gallons | Litres | Gallons | kg | lbs | kg | lbs |
| 0 | 0 | 0 | 0 | 0 | 0 | 0 | 0 | 0 | 0 |

(CaCl2, 75%, -30°C) Always use a tube when filled with water/salt.

NOKIAN TYRES HTS L-4S

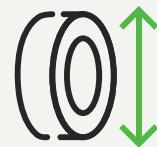

AVAILABLE SIZES

- 18.00-25 - T445329
- 18.00-33 - T445458

NOKIAN TYRES HTS L-4S

ALL SIZES

| Product code | Size | LI/SS | Ply rating | TL/TT | Rim | Permitted rims | Width (mm) | Diameter (mm) | Loaded static radius (mm) | Rolling circumference (mm) | Pressure (kPa) | Max. inflation pressure (kPa) | Tread depth (mm) | Tread code | Tube product code | Min. dual spacing (mm) |
|--------------|----------|-------|------------|-------|-----------|-------------------------|------------|---------------|---------------------------|----------------------------|----------------|-------------------------------|------------------|------------|-------------------|------------------------|
| T445329 | 18.00-25 | 207A5 | 40 | TL | 13.00/2.5 | 13.00/2.5 IF, 15.00/2.5 | 535 | 1673 | 772 | 4935 | 1000 | 1000 | 54 | L-4S | T55831 | 598 |
| T445458 | 18.00-33 | 214A5 | 40 | TL | 13.00/2.5 | 13.00/2.5 IF | 506 | 1863 | 838 | 5617 | 1000 | 1000 | 54 | L-4S | | 598 |

NOKIAN TYRES HTS L-4S 18.00-25 - T445329

| Product code | Size | LI/SS | Ply rating | TL/TT | Rim | Permitted rims | Width (mm) | Diameter (mm) | Loaded static radius (mm) | Rolling circumference (mm) | Pressure (kPa) | Max. inflation pressure (kPa) | Tread depth (mm) | Tread code | Tube product code | Min. dual spacing (mm) |
|--------------|----------|-------|------------|-------|-----------|-------------------------|------------|---------------|---------------------------|----------------------------|----------------|-------------------------------|------------------|------------|-------------------|------------------------|
| T445329 | 18.00-25 | 207A5 | 40 | TL | 13.00/2.5 | 13.00/2.5 IF, 15.00/2.5 | 535 | 1673 | 772 | 4935 | 1000 | 1000 | 54 | L-4S | T55831 | 598 |

WATER AND SALT BALLASTING

| Tire volume 100% | | Water filling 75% | | Water/salt filling (75% / -30°C) | | | | Total weight increase | |
|------------------|---------|-------------------|---------|----------------------------------|---------|------|-----|-----------------------|-----|
| | | | | Water | | Salt | | | |
| Litres | Gallons | Litres | Gallons | Litres | Gallons | kg | lbs | kg | lbs |
| 470 | 124 | 353 | 93 | 289 | 76 | 147 | 325 | 436 | 961 |

(CaCl₂, 75%, -30°C) Always use a tube when filled with water/salt.

TUBES AND VALVES

| | |
|------------------------------------|-------------------------------|
| Tube product code T55831 | Tube valve TR J1175 |
| Tubeless valve TR650 | |

NOKIAN TYRES HTS L-4S 18.00-33 - T445458

| Product code | Size | LI/SS | Ply rating | TL/TT | Rim | Permitted rims | Width (mm) | Diameter (mm) | Loaded static radius (mm) | Rolling circumference (mm) | Pressure (kPa) | Max. inflation pressure (kPa) | Tread depth (mm) | Tread code | Min. dual spacing (mm) |
|--------------|----------|-------|------------|-------|-----------|----------------|------------|---------------|---------------------------|----------------------------|----------------|-------------------------------|------------------|------------|------------------------|
| T445458 | 18.00-33 | 214A5 | 40 | TL | 13.00/2.5 | 13.00/2.5 IF | 506 | 1863 | 838 | 5617 | 1000 | 1000 | 54 | L-4S | 598 |

WATER AND SALT BALLASTING

| Tire volume 100% | | Water filling 75% | | Water/salt filling (75% / -30°C) | | | | Total weight increase | |
|------------------|---------|-------------------|---------|----------------------------------|---------|------|-----|-----------------------|------|
| Litres | Gallons | Litres | Gallons | Water | | Salt | | kg | lbs |
| | | | | Litres | Gallons | kg | lbs | | |
| 520 | 137 | 390 | 103 | 320 | 85 | 163 | 360 | 483 | 1065 |

(CaCl₂, 75%, -30°C) Always use a tube when filled with water/salt.

TUBES AND VALVES

| |
|--------------------------------|
| Tubeless valve TR650 |
|--------------------------------|



EARTHMOVING AND ROAD MAINTENANCE

Nokian Heavy Tyres produces tires for wheel loaders, excavators, graders, backhoe loaders and waste treatment machines. These tires offer supreme grip, driving comfort and durability. Tools for effortless and efficient contracting.

nokian[®]
TYRES

EARTHMOVING AND ROAD MAINTENANCE TIRES

ROAD GRADER



79
Nokian Tyres
GRS

WHEELED EXCAVATOR



83
Nokian Tyres
Excavator

NOKIAN TYRES GRS

SUPERB GRIP FOR GRADERS

- Good winter driving characteristics
- Also for wheel loader use when winter grip is needed
- Excellent drive comfort



2026-05-05

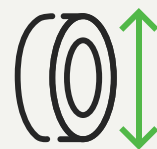

AVAILABLE SIZES

- 14.00R24 - T493551
- 17.5R25 - T493560

NOKIAN TYRES GRS

ALL SIZES

| Product code | Size | LI/SS | TL/TT | Rim | Permitted rims | Width (mm) | Diameter (mm) | Loaded static radius (mm) | Rolling circumference (mm) | Pressure (kPa) | Max. inflation pressure (kPa) | Tread depth (mm) | Tread code | Tube product code | Min. dual spacing (mm) |
|--------------|----------|-------|-------|-----------|----------------------------|------------|---------------|---------------------------|----------------------------|----------------|-------------------------------|------------------|------------|-------------------|------------------------|
| T493551 | 14.00R24 | 153A8 | TL | 10.00VA | 8.00TG, 9.00GR | 369 | 1348 | 614 | 4065 | 375 | 375 | 25 | G-2 | T55767 | 434 |
| T493560 | 17.5R25 | 153A8 | TL | 14.00/1.5 | 14.00/1.3 DC, 13.00/1.4 DC | 450 | 1345 | 605 | 4040 | 300 | 300 | 27 | G-2 | T55867 | 534 |

NOKIAN TYRES GRS 14.00R24 - T493551

| Product code | Size | LI/SS | TL/TT | Rim | Permitted rims | Width (mm) | Diameter (mm) | Loaded static radius (mm) | Rolling circumference (mm) | Pressure (kPa) | Max. inflation pressure (kPa) | Tread depth (mm) | Tread code | Tube product code | Min. dual spacing (mm) |
|--------------|----------|-------|-------|---------|----------------|------------|---------------|---------------------------|----------------------------|----------------|-------------------------------|------------------|------------|-------------------|------------------------|
| T493551 | 14.00R24 | 153A8 | TL | 10.00VA | 8.00TG, 9.00GR | 369 | 1348 | 614 | 4065 | 375 | 375 | 25 | G-2 | T55767 | 434 |

WATER AND SALT BALLASTING

| Tire volume 100% | | Water filling 75% | | Water/salt filling (75% / -30°C) | | | | Total weight increase | |
|------------------|---------|-------------------|---------|----------------------------------|---------|------|-----|-----------------------|-----|
| Litres | Gallons | Litres | Gallons | Water | | Salt | | kg | lbs |
| | | | | Litres | Gallons | kg | lbs | | |
| 230 | 61 | 173 | 46 | 142 | 37 | 72 | 159 | 214 | 472 |

(CaCl₂, 75%, -30°C) Always use a tube when filled with water/salt.

TUBES AND VALVES

| | |
|------------------------------------|------------------------------|
| Tube product code T55767 | Tube valve TR1175A |
| Tubeless valve T650 | |

NOKIAN TYRES GRS 17.5R25 - T493560

| Product code | Size | LI/SS | TL/TT | Rim | Permitted rims | Width (mm) | Diameter (mm) | Loaded static radius (mm) | Rolling circumference (mm) | Pressure (kPa) | Max. inflation pressure (kPa) | Tread depth (mm) | Tread code | Tube product code | Min. dual spacing (mm) |
|--------------|---------|-------|-------|-----------|----------------------------|------------|---------------|---------------------------|----------------------------|----------------|-------------------------------|------------------|------------|-------------------|------------------------|
| T493560 | 17.5R25 | 153A8 | TL | 14.00/1.5 | 14.00/1.3 DC, 13.00/1.4 DC | 450 | 1345 | 605 | 4040 | 300 | 300 | 27 | G-2 | T55867 | 534 |

WATER AND SALT BALLASTING

| Tire volume 100% | | Water filling 75% | | Water/salt filling (75% / -30°C) | | | | Total weight increase | |
|------------------|---------|-------------------|---------|----------------------------------|---------|------|-----|-----------------------|-----|
| Litres | Gallons | Litres | Gallons | Water | | Salt | | kg | lbs |
| | | | | Litres | Gallons | kg | lbs | | |
| 330 | 87 | 248 | 65 | 203 | 54 | 104 | 228 | 307 | 677 |

(CaCl₂, 75%, -30°C) Always use a tube when filled with water/salt.

TUBES AND VALVES

| | |
|------------------------------------|-------------------------------|
| Tube product code T55867 | Tube valve TR J1175 |
| Tubeless valve TR650 | |

NOKIAN TYRES EXCAVATOR

EXCAVATOR TIRE FOR SOFT SURFACES

- Excellent self-cleaning properties with curvy lug design improve traction on soft surfaces.
- High load-bearing capacity and improved stability.
- Steel fortified against punctures with a reinforced shoulder for a long service life.

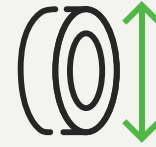

AVAILABLE SIZES

- 600/50-22.5 - T445633
- 710/40-22.5 - T445693
- 650/45-22.5 - T445692

NOKIAN TYRES EXCAVATOR

ALL SIZES

| Product code | Size | LI/SS | Ply rating | Reinforced code | TL/TT | Rim | Permitted rims | Width (mm) | Diameter (mm) | Loaded static radius (mm) | Rolling circumference (mm) | SRI | Pressure (kPa) | Max. inflation pressure (kPa) | Tread depth (mm) | Tube product code | Min. dual spacing (mm) | Load capacity for constant load, kg | | | | | |
|--------------|-------------|-------|------------|-----------------|-------|---------|----------------|------------|---------------|---------------------------|----------------------------|-----|----------------|-------------------------------|------------------|-------------------|------------------------|-------------------------------------|------|------|------|------|------|
| | | | | | | | | | | | | | | | | | | Speed (km/h) | | | | | |
| | | | | | | | | | | | | | | | | | | 25 | 30 | 35 | 40 | 45 | 50 |
| T445633 | 600/50-22.5 | 165A8 | 20 | SF | TL | AG20.00 | | 587 | 1150 | 524 | 3506 | 550 | 450 | 450 | 40 | T55089 | 721 | 5460 | 5355 | 5255 | 5150 | 4945 | 4685 |
| T445692 | 650/45-22.5 | 166A8 | 20 | SF | TL | AG22.00 | AG20.00 | 639 | 1150 | 530 | 3506 | 550 | 450 | 450 | 40 | T55092 | 774 | 5620 | 5510 | 5405 | 5300 | 5090 | 4825 |
| T445693 | 710/40-22.5 | 167A8 | 20 | SF | TL | AG24.00 | | 686 | 1152 | 528 | 3500 | 550 | 450 | 450 | 40 | T55092 | 872 | 5775 | 5670 | 5560 | 5450 | 5230 | 4960 |

NOKIAN TYRES EXCAVATOR 600/50-22.5 - T445633

| Product code | Size | LI/SS | Ply rating | Reinforced code | TL/TT | Rim | Width (mm) | Diameter (mm) | Loaded static radius (mm) | Rolling circumference (mm) | SRI | Pressure (kPa) | Max. inflation pressure (kPa) | Tread depth (mm) | Tube product code | Min. dual spacing (mm) |
|--------------|-------------|-------|------------|-----------------|-------|---------|------------|---------------|---------------------------|----------------------------|-----|----------------|-------------------------------|------------------|-------------------|------------------------|
| T445633 | 600/50-22.5 | 165A8 | 20 | SF | TL | AG20.00 | 587 | 1150 | 524 | 3506 | 550 | 450 | 450 | 40 | T55089 | 721 |

LOAD CAPACITY FOR WHEELED EXCAVATOR, KG

| Pressure (kPa) | Constant load | | | | | | | | | | |
|----------------|---------------|--------|---------|---------|---------|---------|---------|---------|---------|---------|---------|
| | 0 km/h | 5 km/h | 10 km/h | 15 km/h | 20 km/h | 25 km/h | 30 km/h | 35 km/h | 40 km/h | 45 km/h | 50 km/h |
| 200 | 5750 | 3625 | 3125 | 2825 | 2725 | 2650 | 2600 | 2550 | 2500 | 2400 | 2275 |
| 240 | 6900 | 4350 | 3750 | 3390 | 3270 | 3180 | 3120 | 3060 | 3000 | 2880 | 2730 |
| 320 | 8625 | 5440 | 4690 | 4240 | 4090 | 3975 | 3900 | 3825 | 3750 | 3600 | 3415 |
| 360 | 9775 | 6165 | 5315 | 4805 | 4635 | 4505 | 4420 | 4335 | 4250 | 4080 | 3870 |
| 400 | 10640 | 6705 | 5780 | 5225 | 5040 | 4905 | 4810 | 4720 | 4625 | 4440 | 4210 |
| 450 | 11845 | 7470 | 6440 | 5820 | 5615 | 5460 | 5355 | 5255 | 5150 | 4945 | 4685 |

WATER AND SALT BALLASTING

| Tire volume 100% | | Water filling 75% | | Water/salt filling (75% / -30°C) | | | | Total weight increase | |
|------------------|---------|-------------------|---------|----------------------------------|---------|------|-----|-----------------------|-----|
| Litres | Gallons | Litres | Gallons | Water | | Salt | | kg | lbs |
| | | | | Litres | Gallons | kg | lbs | | |
| 270 | 71 | 203 | 53 | 166 | 44 | 85 | 187 | 251 | 553 |

(CaCl₂, 75%, -30°C) Always use a tube when filled with water/salt.

TUBES AND VALVES

| | |
|------------------------------------|-----------------------------|
| Tube product code T55089 | Tube valve TR218A |
| Tubeless valve TR618A | |

NOKIAN TYRES EXCAVATOR 650/45-22.5 - T445692

| Product code | Size | LI/SS | Ply rating | Reinforced code | TL/TT | Rim | Permitted rims | Width (mm) | Diameter (mm) | Loaded static radius (mm) | Rolling circumference (mm) | SRI | Pressure (kPa) | Max. inflation pressure (kPa) | Tread depth (mm) | Tube product code | Min. dual spacing (mm) |
|--------------|-------------|-------|------------|-----------------|-------|---------|----------------|------------|---------------|---------------------------|----------------------------|-----|----------------|-------------------------------|------------------|-------------------|------------------------|
| T445692 | 650/45-22.5 | 166A8 | 20 | SF | TL | AG22.00 | AG20.00 | 639 | 1150 | 530 | 3506 | 550 | 450 | 450 | 40 | T55092 | 774 |

LOAD CAPACITY FOR WHEELED EXCAVATOR, KG

| Pressure (kPa) | Constant load | | | | | | | | | | |
|----------------|---------------|--------|---------|---------|---------|---------|---------|---------|---------|---------|---------|
| | 0 km/h | 5 km/h | 10 km/h | 15 km/h | 20 km/h | 25 km/h | 30 km/h | 35 km/h | 40 km/h | 45 km/h | 50 km/h |
| 200 | 5925 | 3735 | 3220 | 2910 | 2805 | 2730 | 2680 | 2625 | 2575 | 2470 | 2345 |
| 240 | 7075 | 4460 | 3845 | 3475 | 3350 | 3260 | 3200 | 3135 | 3075 | 2950 | 2800 |
| 320 | 8915 | 5620 | 4845 | 4380 | 4225 | 4110 | 4030 | 3955 | 3875 | 3720 | 3525 |
| 360 | 10065 | 6345 | 5470 | 4945 | 4770 | 4640 | 4550 | 4465 | 4375 | 4200 | 3980 |
| 400 | 10925 | 6890 | 5940 | 5370 | 5180 | 5035 | 4940 | 4845 | 4750 | 4560 | 4325 |
| 450 | 12190 | 7685 | 6625 | 5990 | 5775 | 5620 | 5510 | 5405 | 5300 | 5090 | 4825 |

WATER AND SALT BALLASTING

| Tire volume 100% | | Water filling 75% | | Water/salt filling (75% / -30°C) | | | | Total weight increase | |
|------------------|---------|-------------------|---------|----------------------------------|---------|------|-----|-----------------------|-----|
| Litres | Gallons | Litres | Gallons | Water | | Salt | | kg | lbs |
| | | | | Litres | Gallons | kg | lbs | | |
| 293 | 77 | 220 | 58 | 180 | 48 | 92 | 203 | 272 | 600 |

(CaCl₂, 75%, -30°C) Always use a tube when filled with water/salt.

TUBES AND VALVES

| | |
|------------------------------------|-----------------------------|
| Tube product code T55092 | Tube valve TR218A |
| Tubeless valve TR618A | |

NOKIAN TYRES EXCAVATOR 710/40-22.5 - T445693

| Product code | Size | LI/SS | Ply rating | Reinforced code | TL/TT | Rim | Width (mm) | Diameter (mm) | Loaded static radius (mm) | Rolling circumference (mm) | SRI | Pressure (kPa) | Max. inflation pressure (kPa) | Tread depth (mm) | Tube product code | Min. dual spacing (mm) |
|--------------|-------------|-------|------------|-----------------|-------|---------|------------|---------------|---------------------------|----------------------------|-----|----------------|-------------------------------|------------------|-------------------|------------------------|
| T445693 | 710/40-22.5 | 167A8 | 20 | SF | TL | AG24.00 | 686 | 1152 | 528 | 3500 | 550 | 450 | 450 | 40 | T55092 | 872 |

LOAD CAPACITY FOR WHEELED EXCAVATOR, KG

| Pressure (kPa) | Constant load | | | | | | | | | | |
|----------------|---------------|--------|---------|---------|---------|---------|---------|---------|---------|---------|---------|
| | 0 km/h | 5 km/h | 10 km/h | 15 km/h | 20 km/h | 25 km/h | 30 km/h | 35 km/h | 40 km/h | 45 km/h | 50 km/h |
| 200 | 6095 | 3845 | 3315 | 2995 | 2890 | 2810 | 2755 | 2705 | 2650 | 2545 | 2410 |
| 240 | 7245 | 4570 | 3940 | 3560 | 3435 | 3340 | 3275 | 3215 | 3150 | 3025 | 2865 |
| 320 | 9200 | 5800 | 5000 | 4520 | 4360 | 4240 | 4160 | 4080 | 4000 | 3840 | 3640 |
| 360 | 10350 | 6525 | 5625 | 5085 | 4905 | 4770 | 4680 | 4590 | 4500 | 4320 | 4095 |
| 400 | 11215 | 7070 | 6095 | 5510 | 5315 | 5170 | 5070 | 4975 | 4875 | 4680 | 4435 |
| 450 | 12535 | 7905 | 6815 | 6160 | 5940 | 5775 | 5670 | 5560 | 5450 | 5230 | 4960 |

WATER AND SALT BALLASTING

| Tire volume 100% | | Water filling 75% | | Water/salt filling (75% / -30°C) | | | | Total weight increase | |
|------------------|---------|-------------------|---------|----------------------------------|---------|------|-----|-----------------------|-----|
| Litres | Gallons | Litres | Gallons | Water | | Salt | | kg | lbs |
| | | | | Litres | Gallons | kg | lbs | | |
| 327 | 86 | 245 | 65 | 201 | 53 | 103 | 226 | 304 | 670 |

(CaCl2, 75%, -30°C) Always use a tube when filled with water/salt.

TUBES AND VALVES

| | |
|------------------------------------|-----------------------------|
| Tube product code T55092 | Tube valve TR218A |
| Tubeless valve TR618A | |



ALL TERRAIN TRUCKS AND MILITARY VEHICLES

With all-terrain trucks and military vehicles, you never know what weather or terrain lies ahead. That's why Nokian Tyres puts lots of creative passion into developing and customising our line of all-terrain tires. With the expertise gained over the years and feedback from users, we have been able to create designs that give you the best possible performance on any terrain, any time of the year.

nokian[®]
TYRES

ALL TERRAIN TRUCKS AND MILITARY VEHICLES TIRES

OTHER VEHICLES



90

Nokian Tyres
MPT Agile

NOKIAN TYRES MPT AGILE

ON AND OFF ROAD AGILITY

- The open arrow-shaped tread pattern ensures good self-cleaning, ensuring grip under demanding circumstances.
- Improved grip on soft surfaces such as mud and snow.
- Exceptional mobility.



2026105-05

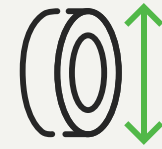

AVAILABLE SIZES

- 14.00R20 - T445231

NOKIAN TYRES MPT AGILE

ALL SIZES

| Product code | Size | LI/SS | Reinforced code | TL/TT | Rim | Permitted rims | Width (mm) | Diameter (mm) | Loaded static radius (mm) | Rolling circumference (mm) | Pressure (kPa) | Max. inflation pressure (kPa) | Tread depth (mm) | Tube product code | M+S | Load capacity for highway service, kg | | | | | |
|--------------|----------|-------|-----------------|-------|--------|-------------------|------------|---------------|---------------------------|----------------------------|----------------|-------------------------------|------------------|-------------------|-----|---------------------------------------|------|------|------|------|------|
| | | | | | | | | | | | | | | | | Speed (km/h) | | | | | |
| | | | | | | | | | | | | | | | | 40 | 50 | 60 | 70 | 80 | 90 |
| T445231 | 14.00R20 | 164G | SB | TL | 10.00V | 10.00W, 10.0, 9.0 | 380 | 1264 | 585 | 3850 | 750 | 750 | 25 | T52920 | Yes | 5350 | 5250 | 5250 | 5250 | 5200 | 5000 |

NOKIAN TYRES MPT AGILE 14.00R20 - T445231

| Product code | Size | LI/SS | Reinforced code | TL/TT | Rim | Permitted rims | Width (mm) | Diameter (mm) | Loaded static radius (mm) | Rolling circumference (mm) | Pressure (kPa) | Max. inflation pressure (kPa) | Tread depth (mm) | Tube product code | M+S |
|--------------|----------|-------|-----------------|-------|--------|-------------------|------------|---------------|---------------------------|----------------------------|----------------|-------------------------------|------------------|-------------------|-----|
| T445231 | 14.00R20 | 164G | SB | TL | 10.00V | 10.00W, 10.0, 9.0 | 380 | 1264 | 585 | 3850 | 750 | 750 | 25 | T52920 | Yes |

LOAD CAPACITY, KG

| Pressure (kPa) | Cross country | | | | | | | | | Highway service | | | | | | | | | | |
|----------------|---------------|--------|---------|---------|---------|---------|---------|---------|---------|-----------------|--------|---------|---------|---------|---------|---------|---------|---------|---------|---------|
| | 0 km/h | 5 km/h | 10 km/h | 20 km/h | 30 km/h | 40 km/h | 50 km/h | 60 km/h | 70 km/h | 0 km/h | 5 km/h | 10 km/h | 20 km/h | 30 km/h | 40 km/h | 50 km/h | 60 km/h | 70 km/h | 80 km/h | 90 km/h |
| 300 | 5770 | 5260 | 4650 | 4070 | 3860 | 3660 | 3660 | 3660 | 3620 | | | | | | | | | | | |
| 375 | | | 5560 | 4870 | 4610 | 4370 | 4370 | 4370 | 4330 | | | | | | | | | | | |
| 450 | | | | 5630 | 5330 | 5060 | 5060 | 5060 | 5010 | 6350 | 5320 | 4850 | 4290 | 3750 | 3560 | 3490 | 3490 | 3490 | 3460 | 3320 |
| 600 | | | | | | | | | | 7990 | 6690 | 6110 | 5400 | 4730 | 4480 | 4390 | 4390 | 4390 | 4350 | 4180 |
| 750 | | | | | | | | | | | | | 6450 | 5650 | 5350 | 5250 | 5250 | 5250 | 5200 | 5000 |

WATER AND SALT BALLASTING

| Tire volume 100% | | Water filling 75% | | Water/salt filling (75% / -30°C) | | | | Total weight increase | |
|------------------|---------|-------------------|---------|----------------------------------|---------|------|-----|-----------------------|-----|
| Litres | Gallons | Litres | Gallons | Water | | Salt | | kg | lbs |
| | | | | Litres | Gallons | kg | lbs | | |
| 245 | 65 | 184 | 49 | 151 | 40 | 77 | 169 | 228 | 503 |

(CaCl₂, 75%, -30°C) Always use a tube when filled with water/salt.

TUBES AND VALVES

| | |
|------------------------------------|-------------------------------|
| Tube product code T52920 | Tube valve V3-02-19 |
| Tubeless valve T650 | |

STUDDABLE

| | |
|---------------------------------------|-----------------------------------|
| Studdable Yes | Number of studs 198 pcs |
| Marked stud positions on tread | Recommended stud 11-15 |

A large truck is shown from a side-rear perspective, driving on a snowy road at night. The truck's trailer is heavily loaded with stacks of tires, secured with chains. The truck's headlights and side lights are on, illuminating the snow. The background shows a dark, snowy forest with snow falling from the sky. The overall scene is dimly lit, emphasizing the winter and nighttime conditions.

TRUCKS AND BUSES

Nokian truck and bus tires are designed for demanding professional use in varying conditions with the aim of ensuring safe driving in all weather and road conditions. In our own test centres in Ivalo, Lapland, and in Nokia we test extreme driving situations in all seasons. Further development of the tires involves millions of kilometres of driving in different environments and in all kinds of weather conditions.

nokian[®]
TYRES

TRUCKS AND BUSES TIRES

STEER



95
Nokian Tyres
Hakkapeliitta
Truck F2

DRIVE



97
Nokian Tyres
E-Truck Drive

TRAILER



99
Nokian Tyres
Hakka Truck
844



101
Nokian Tyres
E-Truck Trailer

OTHER VEHICLES



103
Nokian Tyres
Hakka Truck
Steer



105
Nokian Tyres
Hakkapeliitta
Truck D2

NOKIAN TYRES HAKKAPELIITTA TRUCK F2

**WINTER STEER AXLE TIRE – GRIP FOR
DEMANDING WINTER CONDITIONS IN
REGIONAL AND LONG-DISTANCE
TRANSPORT**

- Aggressive pattern, deep grooves and a new shoulder design enable reference-level grip and good self-cleaning.
- Improved Spiral Sipe System keeps the siping effective even when the tire wears down.
- New, large stone ejectors protect the tire from stone trapping.



2026-05-05

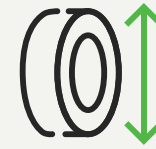

AVAILABLE SIZES

- 385/55R22.5 - T675236

NOKIAN TYRES HAKKAPELIITTA TRUCK F2

ALL SIZES

| Product code | Size | LI/SS | TL/TT | Rim | Permitted rims | Width (mm) | Diameter (mm) | Loaded static radius (mm) | Rolling circumference (mm) | Pressure (kPa) | Tread depth (mm) | Rolling resistance | Wet grip | Noise class | Noise (dB) | M+S | Snow grip marking (3PMSF) |
|--------------|-------------|-------------|-------|-------|----------------|------------|---------------|---------------------------|----------------------------|----------------|------------------|--------------------|----------|-------------|------------|-----|---------------------------|
| T675236 | 385/55R22.5 | 160K (158L) | TL | 11.75 | 12.25 | 386 | 996 | 464 | 3027 | 900 | 15 | D | B | B | 74 | Yes | Yes |

LOAD CAPACITIES

| Product code | Size | Fitting | Reference speed km/h | Maximum load capacity per axle (kg) at various cold inflation pressures (kPa) | | | | | | | | | | |
|--------------|-------------|---------|-------------------------|---|------|------|------|------|------|------|------|------|------|------|
| | | | | 650 | 675 | 700 | 725 | 750 | 775 | 800 | 825 | 850 | 875 | 900 |
| T675236 | 385/55R22.5 | Single | 110 | 6940 | 7150 | 7360 | 7570 | 7780 | 7990 | 8190 | 8390 | 8600 | 8800 | 9000 |
| | | Single | 120 | 6860 | 7070 | 7280 | 7480 | 7690 | 7890 | 8100 | 8300 | 8500 | | |

Note! The inflation pressures given in the table are minimum values. It is recommended to use 0.5-1.0 bar higher values to compensate the effect of temperature variation and possible pressure gauge error, but not more than 9.0 bar should be used.

NOKIAN TYRES E-TRUCK DRIVE

ALL-SEASON DRIVE AXLE TIRE -RELIABLE TRACTION AND EVEN WEAR FOR REGIONAL TRANSPORT

- Effective block pattern and open center tread design ensure good traction.
- Even wear pattern for a long, trouble-free service life.
- Low rolling resistance and tire noise for fuel economy and comfort.

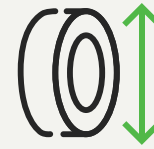

AVAILABLE SIZES

- 295/80R22.5 - T675225
- 315/70R22.5 - T675281
- 315/70R22.5 - T675224

NOKIAN TYRES E-TRUCK DRIVE

ALL SIZES

| Product code | Size | LI/SS | TL/TT | Rim | Permitted rims | Width (mm) | Diameter (mm) | Loaded static radius (mm) | Rolling circumference (mm) | Pressure (kPa) | Tread depth (mm) | Min. dual spacing (mm) | Rolling resistance | Wet grip | Noise class | Noise (dB) | M+S | Snow grip marking (3PMSF) |
|--------------|-------------|---------------------|-------|------|----------------|------------|---------------|---------------------------|----------------------------|----------------|------------------|------------------------|--------------------|----------|-------------|------------|-----|---------------------------|
| T675225 | 295/80R22.5 | 152/148M | TL | 8.25 | | 298 | 1044 | 491 | 3204 | 850 | 17.5 | 335 | D | C | B | 75 | Yes | Yes |
| T675224 | 315/70R22.5 | 154/150L (152/148M) | TL | 9.00 | 9.75 | 314 | 1027 | 474 | 3122 | 900 | 17.5 | 351 | D | B | A | 73 | Yes | Yes |
| T675281 | 315/70R22.5 | 154/150L (152/148M) | TL | 9.00 | 9.75 | 314 | 1027 | 474 | 3122 | 900 | 17.5 | 351 | C | C | A | 73 | Yes | Yes |

LOAD CAPACITIES

| Product code | Size | Fitting | Reference speed km/h | Maximum load capacity per axle (kg) at various cold inflation pressures (kPa) | | | | | | | | | | |
|--------------|-------------|---------|-------------------------|---|-------|-------|-------|-------|-------|-------|-------|-------|-------|-------|
| | | | | 650 | 675 | 700 | 725 | 750 | 775 | 800 | 825 | 850 | 875 | 900 |
| T675225 | 295/80R22.5 | Single | 130 | 5730 | 5900 | 6080 | 6250 | 6420 | 6590 | 6760 | 6930 | 7100 | | |
| | | Dual | 130 | 10170 | 10480 | 10790 | 11090 | 11400 | 11700 | 12000 | 12300 | 12600 | | |
| T675224 | 315/70R22.5 | Single | 120 | 5780 | 5960 | 6130 | 6310 | 6480 | 6650 | 6830 | 7000 | 7160 | 7330 | 7500 |
| | | Dual | 120 | 10330 | 10650 | 10960 | 11270 | 11580 | 11890 | 12200 | 12500 | 12800 | 13100 | 13400 |
| | | Single | 130 | 5730 | 5900 | 6080 | 6250 | 6420 | 6590 | 6760 | 6930 | 7100 | | |
| | | Dual | 130 | 10170 | 10480 | 10790 | 11090 | 11400 | 11700 | 12000 | 12300 | 12600 | | |
| T675281 | 315/70R22.5 | Single | 120 | 5780 | 5960 | 6130 | 6310 | 6480 | 6650 | 6830 | 7000 | 7160 | 7330 | 7500 |
| | | Dual | 120 | 10330 | 10650 | 10960 | 11270 | 11580 | 11890 | 12200 | 12500 | 12800 | 13100 | 13400 |
| | | Single | 130 | 5730 | 5900 | 6080 | 6250 | 6420 | 6590 | 6760 | 6930 | 7100 | | |
| | | Dual | 130 | 10170 | 10480 | 10790 | 11090 | 11400 | 11700 | 12000 | 12300 | 12600 | | |

Note! The inflation pressures given in the table are minimum values. It is recommended to use 0.5-1.0 bar higher values to compensate the effect of temperature variation and possible pressure gauge error, but not more than 9.0 bar should be used.

NOKIAN TYRES HAKKA TRUCK 844

STURDY TIRE FOR ALL SEASONS

- Belt structure ensures even wear and excellent mileage.
- The Spiral Sipe System maintains tire properties even when worn.
- Stone ejectors in the main grooves reduce stone trapping.



2026-05-05

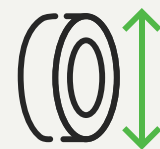

AVAILABLE SIZES

- 265/70R19.5 - T675028

NOKIAN TYRES HAKKA TRUCK 844

ALL SIZES

| Product code | Size | LI/SS | TL/TT | Rim | Permitted rims | Width (mm) | Diameter (mm) | Loaded static radius (mm) | Rolling circumference (mm) | Tread depth (mm) | Min. dual spacing (mm) | M+S | Snow grip marking (3PMSF) |
|--------------|-------------|----------|-------|------|----------------|------------|---------------|---------------------------|----------------------------|------------------|------------------------|-----|---------------------------|
| T675028 | 265/70R19.5 | 143/141J | TL | 7.50 | 6.75, 8.25 | 251 | 872 | 403 | 2650 | 14 | 295 | Yes | Yes |

NOKIAN TYRES E-TRUCK TRAILER

ALL-SEASON TRAILER TIRE – STABILITY AND GRIP FOR REGIONAL TRANSPORT

- New zigzag-shaped grooves improve stability.
- Groove design reduces stone trapping, resulting in longer tire life.
- Good grip on main road use.

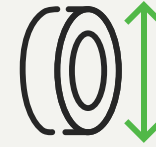

AVAILABLE SIZES

- 385/55R22.5 - T675227

NOKIAN TYRES E-TRUCK TRAILER

ALL SIZES

| Product code | Size | LI/SS | TL/TT | Rim | Permitted rims | Width (mm) | Diameter (mm) | Loaded static radius (mm) | Rolling circumference (mm) | Pressure (kPa) | Tread depth (mm) | Rolling resistance | Wet grip | Noise class | Noise (dB) | M+S | Snow grip marking (3PMSF) |
|--------------|-------------|-------------|-------|-------|----------------|------------|---------------|---------------------------|----------------------------|----------------|------------------|--------------------|----------|-------------|------------|-----|---------------------------|
| T675227 | 385/55R22.5 | 160K (158L) | TL | 11.75 | 12.25 | 384 | 1000 | 466 | 3040 | 900 | 14 | C | B | B | 72 | Yes | Yes |

LOAD CAPACITIES

| Product code | Size | Fitting | Reference speed km/h | Maximum load capacity per axle (kg) at various cold inflation pressures (kPa) | | | | | | | | | | |
|--------------|-------------|---------|-------------------------|---|------|------|------|------|------|------|------|------|------|------|
| | | | | 650 | 675 | 700 | 725 | 750 | 775 | 800 | 825 | 850 | 875 | 900 |
| T675227 | 385/55R22.5 | Single | 110 | 6940 | 7150 | 7360 | 7570 | 7780 | 7990 | 8190 | 8390 | 8600 | 8800 | 9000 |
| | | Single | 120 | 6860 | 7070 | 7280 | 7480 | 7690 | 7890 | 8100 | 8300 | 8500 | | |

Note! The inflation pressures given in the table are minimum values. It is recommended to use 0.5-1.0 bar higher values to compensate the effect of temperature variation and possible pressure gauge error, but not more than 9.0 bar should be used.

NOKIAN TYRES HAKKA TRUCK STEER

**ALL-WEATHER STEER AXLE TIRE –
EXCELLENT MILEAGE FOR REGIONAL
TRANSPORT**

- Wide, slow-wearing tread for excellent mileage.
- New kind of sipe activators improve grip on snowy and wet surfaces.
- Stone ejectors protect the tire from stone trapping.

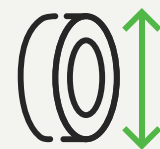

AVAILABLE SIZES

- 385/65R22.5 - T675287

NOKIAN TYRES HAKKA TRUCK STEER

ALL SIZES

| Product code | Size | LI/SS | TL/TT |
|--------------|-------------|-------|-------|
| T675287 | 385/65R22.5 | 164K | TL |

NOKIAN TYRES HAKKAPELIITTA TRUCK D2

WINTER DRIVE AXLE TIRE – ENHANCED WEAR RESISTANCE AND GRIP ON WINTER ROADS

- Deeper reach, better worn grip and improved stability due to peg siping and open center tread design.
- Patented Twin-Block pattern design to achieve superior stability and traction especially on packed snow and icy roads.
- New generation of Hakkapeliitta Truck D family with better mileage performance.

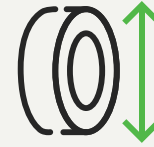

AVAILABLE SIZES

- 295/80R22.5 - T675277

NOKIAN TYRES HAKKAPELIITTA TRUCK D2

ALL SIZES

| Product code | Size | LI/SS | TL/TT |
|--------------|-------------|----------|-------|
| T675277 | 295/80R22.5 | 152/148M | TL |

GENERAL INFO

Nokian Heavy Tyres is passionate in developing high quality solutions for the most extreme conditions found in forests, modern day farming, municipal contracting, transportation terminals and underground applications. In addition to tire and supplementary item information, this manual focuses on the special necessities and requirements in each product category. The forestry section, for example, has a detailed guide on the right tire and inflation pressure choice by application. This technical manual will be your tool in finding the right tire for your work, with a promise on carefree working hours.

TIRE MARKINGS

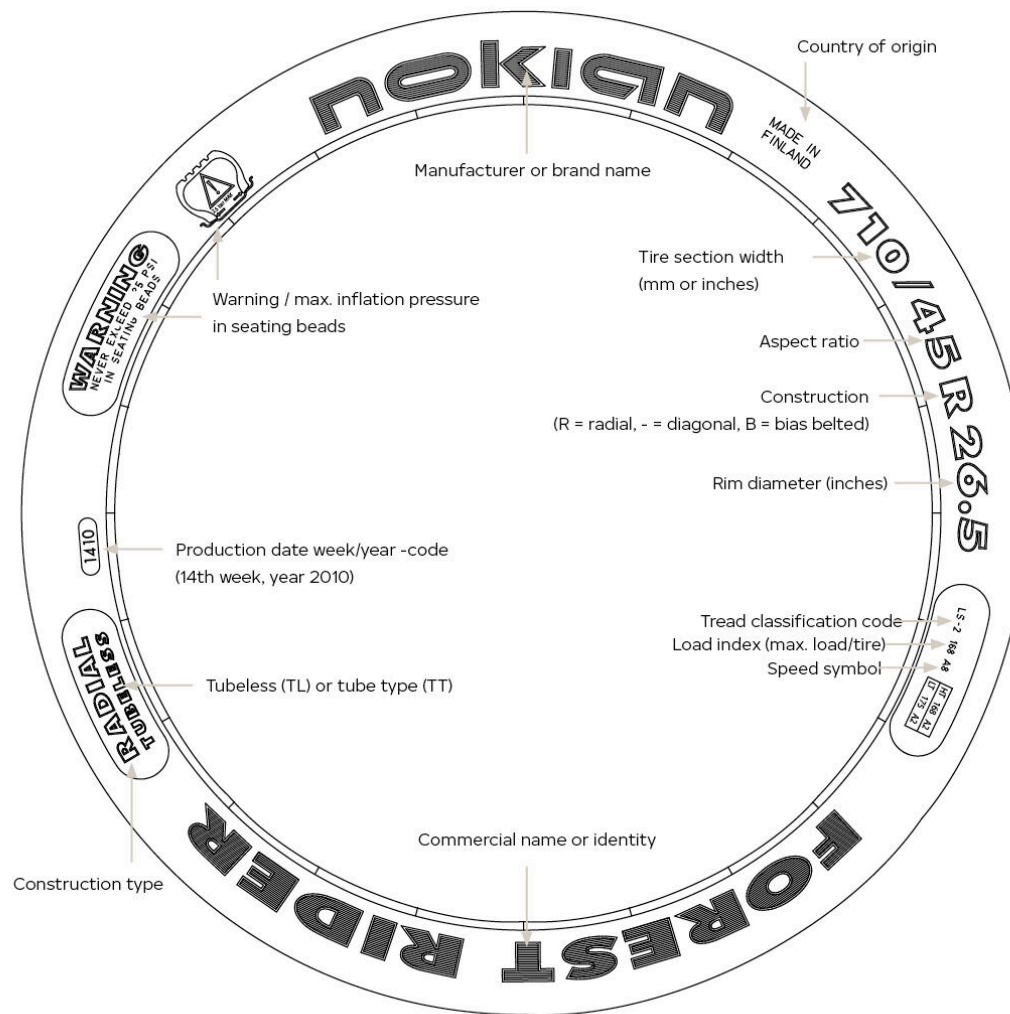

TIRE CLASSIFICATION CODES

OPTIONAL MARKING

| TRA Code | Tread type |
|---|---|
| Agricultural tractor drive wheel tires | |
| R-1 | Regular service (tread) |
| R-1W | Wet traction service |
| R-1S | Sprayer / spreader service |
| R-2 | Cane and rice service (deep tread) |
| R-3 | Flotation service (shallow tread) |
| R-4 | Industrial service (construction application) |
| Agricultural tractor steering wheel tires (non-traction pattern) | |
| F-1 | Single rib tread |
| F-2 | Multiple rib tread |
| F-3 | Industrial service (construction application) |
| Agricultural implement tires | |
| I-1 | Multi-rib tread |
| I-2 | Moderate traction service |
| I-3 | Traction tread |
| I-4 | Plough tail wheel service |
| I-5 | Steering service |
| I-6 | Smooth tread |
| Garden tractor tires (implement tires) | |
| G-1 | Traction service |
| G-2 | Flotation traction service |
| G-3 | Maximum flotation service |

| TRA Code | Tread type |
|--|--------------------|
| Grader tires (Motor graders) | |
| G-2 | Traction regular |
| G-3 | Rock regular |
| Logging and forestry service tires | |
| LS-1 | Regular tread |
| LS-2 | Intermediate tread |
| LS-3 | Deep tread |
| LS-4 | Shallow tread |
| High flotation tires for off-the-road service | |
| HF-1 | Shallow tread |
| HF-2 | Regular tread |
| HF-3 | Deep tread |
| HF-4 | Extra deep tread |
| Earthmover tires (Dump trucks and scrapers) | |
| E-1 | Rib regular |
| E-2 | Traction regular |
| E-3 | Rock regular |
| E-4 | Rock deep tread |
| E-7 | Flotation |
| Loader and dozer tires (Front-end loaders and dozers) | |
| L-2 | Traction regular |
| L-3 | Rock regular |
| L-4 | Rock deep tread |

| TRA Code | Tread type |
|--|-------------------------|
| L-5 | Rock extra deep tread |
| L-4S | Smooth deep tread |
| L-5S | Smooth extra deep tread |
| Compactor tires | |
| C-1 | Smooth |
| Industrial tires (Straddle carriers, transfer cranes, towing tractors, reach stackers and fork lifts) | |
| IND-3 | Traction regular |
| IND-4 | Deep tread |
| IND-5 | Extra deep tread |

Notice! TRA = Tire and Rim Association Inc.

LOAD INDEX

THE LOAD INDEX (LI) IS A NUMERICAL CODE ASSOCIATED WITH THE MAXIMUM LOAD A TIRE CAN CARRY.

| LI | kg | LI | kg | LI | kg | LI | kg | LI | kg | LI | kg | LI | kg | LI | kg | LI | kg | LI | kg | LI | kg | LI | kg | LI | kg |
|----|------|----|------|----|-----|----|-----|-----|-------|-----|-------|-----|-------|-----|-------|-----|--------|-----|--------|-----|--------|-----|--------|-----|---------|
| 0 | 45 | 22 | 85 | 44 | 160 | 66 | 300 | 88 | 560 | 110 | 1 060 | 132 | 2 000 | 154 | 3 750 | 176 | 7 100 | 198 | 13 200 | 220 | 25 000 | 242 | 47 500 | 264 | 90 000 |
| 1 | 46.2 | 23 | 87.5 | 45 | 165 | 67 | 307 | 89 | 580 | 111 | 1 090 | 133 | 2 060 | 155 | 3 875 | 177 | 7 300 | 199 | 13 600 | 221 | 25 750 | 243 | 48 750 | 265 | 92 500 |
| 2 | 47.5 | 24 | 90 | 46 | 170 | 68 | 315 | 90 | 600 | 112 | 1 120 | 134 | 2 120 | 156 | 4 000 | 178 | 7 500 | 200 | 14 000 | 222 | 26 500 | 244 | 50 000 | 266 | 95 000 |
| 3 | 48.7 | 25 | 92.5 | 47 | 175 | 69 | 325 | 91 | 615 | 113 | 1 150 | 135 | 2 180 | 157 | 4 125 | 179 | 7 750 | 201 | 14 500 | 223 | 27 250 | 245 | 51 500 | 267 | 97 500 |
| 4 | 50 | 26 | 95 | 48 | 180 | 70 | 335 | 92 | 630 | 114 | 1 180 | 136 | 2 240 | 158 | 4 250 | 180 | 8 000 | 202 | 15 000 | 224 | 28 000 | 246 | 53 000 | 268 | 100 000 |
| 5 | 51.5 | 27 | 97.5 | 49 | 185 | 71 | 345 | 93 | 650 | 115 | 1 215 | 137 | 2 300 | 159 | 4 375 | 181 | 8 250 | 203 | 15 500 | 225 | 29 000 | 247 | 54 500 | 269 | 103 000 |
| 6 | 53 | 28 | 100 | 50 | 190 | 72 | 355 | 94 | 670 | 116 | 1 250 | 138 | 2 360 | 160 | 4 500 | 182 | 8 500 | 204 | 16 000 | 226 | 30 000 | 248 | 56 000 | 270 | 106 000 |
| 7 | 54.5 | 29 | 193 | 51 | 195 | 73 | 365 | 95 | 690 | 117 | 1 285 | 139 | 2 430 | 161 | 4 625 | 183 | 8 750 | 205 | 16 500 | 227 | 30 750 | 249 | 58 000 | 271 | 109 000 |
| 8 | 56 | 30 | 106 | 52 | 200 | 74 | 375 | 96 | 710 | 118 | 1 320 | 140 | 2 500 | 162 | 4 750 | 184 | 9 000 | 206 | 17 000 | 228 | 31 500 | 250 | 60 000 | 272 | 112 000 |
| 9 | 58 | 31 | 109 | 53 | 206 | 75 | 387 | 97 | 730 | 119 | 1 360 | 141 | 2 575 | 163 | 4 875 | 185 | 9 250 | 207 | 17 500 | 229 | 32 500 | 251 | 61 500 | 273 | 115 000 |
| 10 | 60 | 32 | 112 | 54 | 212 | 76 | 400 | 98 | 750 | 120 | 1 400 | 142 | 2 650 | 164 | 5 000 | 186 | 9 500 | 208 | 18 000 | 230 | 33 500 | 252 | 63 000 | 274 | 118 000 |
| 11 | 61.5 | 33 | 115 | 55 | 218 | 77 | 412 | 99 | 775 | 121 | 1 450 | 143 | 2 725 | 165 | 5 150 | 187 | 9 750 | 209 | 18 500 | 231 | 34 500 | 253 | 65 000 | 275 | 121 000 |
| 12 | 63 | 34 | 118 | 56 | 224 | 78 | 425 | 100 | 800 | 122 | 1 500 | 144 | 2 800 | 166 | 5 300 | 188 | 10 000 | 210 | 19 000 | 232 | 35 500 | 254 | 67 000 | 276 | 125 000 |
| 13 | 65 | 35 | 121 | 57 | 230 | 79 | 437 | 101 | 825 | 123 | 1 550 | 145 | 2 900 | 167 | 5 450 | 189 | 10 300 | 211 | 19 500 | 233 | 36 500 | 255 | 69 000 | 277 | 128 500 |
| 14 | 67 | 36 | 125 | 58 | 236 | 80 | 450 | 102 | 850 | 124 | 1 600 | 146 | 3 000 | 168 | 5 600 | 190 | 10 600 | 212 | 20 000 | 234 | 37 500 | 256 | 71 000 | 278 | 132 000 |
| 15 | 69 | 37 | 128 | 59 | 243 | 81 | 462 | 103 | 875 | 125 | 1 650 | 147 | 3 075 | 169 | 5 800 | 191 | 10 900 | 213 | 20 600 | 235 | 38 750 | 257 | 73 000 | 279 | 136 000 |
| 16 | 71 | 38 | 132 | 60 | 250 | 82 | 475 | 104 | 900 | 126 | 1 700 | 148 | 3 150 | 170 | 6 000 | 192 | 11 200 | 214 | 21 200 | 236 | 40 000 | 258 | 75 000 | | |
| 17 | 73 | 39 | 136 | 61 | 257 | 83 | 487 | 105 | 925 | 127 | 1 750 | 149 | 3 250 | 171 | 6 150 | 193 | 11 500 | 215 | 21 800 | 237 | 41 250 | 259 | 77 500 | | |
| 18 | 75 | 40 | 140 | 62 | 265 | 84 | 500 | 106 | 950 | 128 | 1 800 | 150 | 3 350 | 172 | 6 300 | 194 | 11 800 | 216 | 22 400 | 238 | 42 500 | 260 | 80 000 | | |
| 19 | 77.5 | 41 | 145 | 63 | 272 | 85 | 515 | 107 | 975 | 129 | 1 850 | 151 | 3 450 | 173 | 6 500 | 195 | 12 150 | 217 | 23 000 | 239 | 43 750 | 261 | 82 500 | | |
| 20 | 80 | 42 | 150 | 64 | 280 | 86 | 530 | 108 | 1 000 | 130 | 1 900 | 152 | 3 550 | 174 | 6 700 | 196 | 12 500 | 218 | 23 600 | 240 | 45 000 | 262 | 85 000 | | |
| 21 | 82.5 | 43 | 155 | 65 | 290 | 87 | 545 | 109 | 1 030 | 131 | 1 950 | 153 | 3 650 | 175 | 6 900 | 197 | 12 850 | 219 | 24 300 | 241 | 46 250 | 263 | 87 500 | | |

Example: 157 A8 a tire can carry maximum 4125 kg at the maximum speed of 40 km/h.

UNITS

| Quantity | S.I. units | Other units |
|----------|--------------------|--|
| Length | m (metre) | 1 inch (") = 0.0254 m (or 25.4 mm) |
| | | 1 mile = 1 609 m (or 1.609 km) |
| Mass | kg (kilogram) | 1 pound (lb) = 0.4536 kg |
| Pressure | Pa (Pascal) | 1 bar = 100 kPa |
| | | 1 pound per square inch (psi or lb/in ²) = 6.895 kPa |
| | | 1 kg/cm ² = 98.066 kPa |
| Speed | m/s | 1 km per hour (km/h) = 0.277778 m/s |
| | (metre per second) | 1 mile per hour (mph) = 0.4470 m/s (or 1.60935 km/h) |

PICTOGRAM

MARKED ON BOTH TIRE SIDEWALLS

Expects the maximum inflation pressure not to be exceeded for bead seating during tire mounting. The value of inflation pressure (2.5 bar in the example) must be the same as specified by the tire manufacturer.



Speed symbol

The SPEED SYMBOL (SS) indicates the maximum speed at which the tire can carry a load corresponding to its Load Index.

| SS | km/h | mph |
|----|------|------|
| A1 | 5 | 2.5 |
| A2 | 10 | 5 |
| A3 | 15 | 10 |
| A4 | 20 | 12.5 |
| A5 | 25 | 15 |
| A6 | 30 | 20 |
| A7 | 35 | 22.5 |
| A8 | 40 | 25 |
| B | 50 | 30 |
| C | 60 | 35 |
| D | 65 | 40 |
| E | 70 | 43 |
| F | 80 | 50 |
| G | 90 | 55 |
| J | 100 | 62 |
| K | 110 | 68 |
| L | 120 | 75 |
| M | 130 | 81 |
| N | 140 | 87 |
| P | 150 | 93 |
| Q | 160 | 99 |
| R | 170 | 106 |
| S | 180 | 112 |
| T | 190 | 118 |

LOW SPOT MARKING (UPON REQUEST)

This marking is used for match-mounting tires on agricultural tractor wheels equipped with a high spot marking.

In the tire industry, **low spot marking** refers to the identification and marking of the area on a tire that has the lowest radial runout, meaning the point where the tire's tread or sidewall is closest to the center of the wheel. This process is crucial for ensuring optimal tire balance and reducing vibrations when the tire is mounted on a vehicle.

Key Details:

- **Radial Runout:** Radial runout is the measurement of how much a tire's radius varies as it rotates. Ideally, the tire should be perfectly round, but manufacturing imperfections can cause slight variations.
- **Low Spot:** The low spot is the point on the tire where the distance from the tire's center (or hub) to the tread or sidewall is the shortest. This is identified using specialized equipment that measures the tire's geometry.
- **Marking:** Once the low spot is identified, it is marked with a white colored dot on the tire's sidewall. This marking helps technicians during the tire mounting process.
- **Tire and Wheel Matching:** The low spot marking is used in conjunction with the high spot marking on the wheel (the point where the wheel's radial runout is the greatest) to optimize the mounting process. By aligning the tire's low spot with the wheel's high spot, the overall radial runout is minimized, which leads to a smoother ride and better tire performance.

This practice is part of the tire and wheel balancing process and helps to ensure that the vehicle operates smoothly and that the tires wear evenly over time.



PRESSURE UNIT, CONVERSION TABLE

| kPa | bar | * lbs/in ² (psi) | * kg/cm ² | kPa | bar | * lbs/in ² (psi) | * kg/cm ² | kPa | bar | * lbs/in ² (psi) | * kg/cm ² | kPa | bar | * lbs/in ² (psi) | * kg/cm ² | kPa | bar | * lbs/in ² (psi) | * kg/cm ² |
|-----|-----|-----------------------------|----------------------|-----|-----|-----------------------------|----------------------|-----|-----|-----------------------------|----------------------|-----|-----|-----------------------------|----------------------|------|------|-----------------------------|----------------------|
| 10 | 0.1 | 1 | 0.1 | 230 | 2.3 | 33 | 2.3 | 450 | 4.5 | 65 | 4.6 | 670 | 6.7 | 97 | 6.8 | 890 | 8.9 | 129 | 9.1 |
| 20 | 0.2 | 3 | 0.2 | 240 | 2.4 | 35 | 2.4 | 460 | 4.6 | 67 | 4.7 | 680 | 6.8 | 99 | 6.9 | 900 | 9.0 | 131 | 9.2 |
| 30 | 0.3 | 4 | 0.3 | 250 | 2.5 | 36 | 2.5 | 470 | 4.7 | 68 | 4.8 | 690 | 6.9 | 100 | 7.0 | 910 | 9.1 | 132 | 9.3 |
| 40 | 0.4 | 6 | 0.4 | 260 | 2.6 | 38 | 2.7 | 480 | 4.8 | 70 | 4.9 | 700 | 7.0 | 102 | 7.1 | 920 | 9.2 | 133 | 9.4 |
| 50 | 0.5 | 7 | 0.5 | 270 | 2.7 | 39 | 2.8 | 490 | 4.9 | 71 | 5.0 | 710 | 7.1 | 103 | 7.2 | 930 | 9.3 | 135 | 9.5 |
| 60 | 0.6 | 9 | 0.6 | 280 | 2.8 | 41 | 2.9 | 500 | 5.0 | 73 | 5.1 | 720 | 7.2 | 104 | 7.3 | 940 | 9.4 | 136 | 9.6 |
| 70 | 0.7 | 10 | 0.7 | 290 | 2.9 | 42 | 3.0 | 510 | 5.1 | 74 | 5.2 | 730 | 7.3 | 106 | 7.4 | 950 | 9.5 | 138 | 9.7 |
| 80 | 0.8 | 12 | 0.8 | 300 | 3.0 | 44 | 3.1 | 520 | 5.2 | 75 | 5.3 | 740 | 7.4 | 107 | 7.5 | 960 | 9.6 | 139 | 9.8 |
| 90 | 0.9 | 13 | 0.9 | 310 | 3.1 | 45 | 3.2 | 530 | 5.3 | 77 | 5.4 | 750 | 7.5 | 109 | 7.6 | 970 | 9.7 | 141 | 9.9 |
| 100 | 1.0 | 15 | 1.0 | 320 | 3.2 | 46 | 3.3 | 540 | 5.4 | 78 | 5.5 | 760 | 7.6 | 110 | 7.7 | 980 | 9.8 | 142 | 10.0 |
| 110 | 1.1 | 16 | 1.1 | 330 | 3.3 | 48 | 3.4 | 550 | 5.5 | 80 | 5.6 | 770 | 7.7 | 112 | 7.9 | 990 | 9.9 | 144 | 10.1 |
| 120 | 1.2 | 17 | 1.2 | 340 | 3.4 | 49 | 3.5 | 560 | 5.6 | 81 | 5.7 | 780 | 7.8 | 113 | 8.0 | 1000 | 10.0 | 145 | 10.2 |
| 130 | 1.3 | 19 | 1.3 | 350 | 3.5 | 51 | 3.6 | 570 | 5.7 | 83 | 5.8 | 790 | 7.9 | 115 | 8.1 | 1010 | 10.1 | 146 | 10.3 |
| 140 | 1.4 | 20 | 1.4 | 360 | 3.6 | 52 | 3.7 | 580 | 5.8 | 84 | 5.9 | 800 | 8.0 | 116 | 8.2 | 1020 | 10.2 | 148 | 10.4 |
| 150 | 1.5 | 22 | 1.5 | 370 | 3.7 | 54 | 3.8 | 590 | 5.9 | 86 | 6.0 | 810 | 8.1 | 117 | 8.3 | 1030 | 10.3 | 149 | 10.5 |
| 160 | 1.6 | 23 | 1.6 | 380 | 3.8 | 55 | 3.9 | 600 | 6.0 | 87 | 6.1 | 820 | 8.2 | 119 | 8.4 | 1040 | 10.4 | 151 | 10.6 |
| 170 | 1.7 | 25 | 1.7 | 390 | 3.9 | 57 | 4.0 | 610 | 6.1 | 88 | 6.2 | 830 | 8.3 | 120 | 8.5 | 1050 | 10.5 | 152 | 10.7 |
| 180 | 1.8 | 26 | 1.8 | 400 | 4.0 | 58 | 4.1 | 620 | 6.2 | 90 | 6.3 | 840 | 8.4 | 122 | 8.6 | 1060 | 10.6 | 154 | 10.8 |
| 190 | 1.9 | 28 | 1.9 | 410 | 4.1 | 59 | 4.2 | 630 | 6.3 | 91 | 6.4 | 850 | 8.5 | 123 | 8.7 | 1070 | 10.7 | 155 | 10.9 |
| 200 | 2.0 | 29 | 2.0 | 420 | 4.2 | 61 | 4.3 | 640 | 6.4 | 93 | 6.5 | 860 | 8.6 | 125 | 8.8 | 1080 | 10.8 | 157 | 11.0 |
| 210 | 2.1 | 30 | 2.1 | 430 | 4.3 | 62 | 4.4 | 650 | 6.5 | 94 | 6.6 | 870 | 8.7 | 126 | 8.9 | 1090 | 10.9 | 158 | 11.1 |
| 220 | 2.2 | 32 | 2.2 | 440 | 4.4 | 64 | 4.5 | 660 | 6.6 | 96 | 6.7 | 880 | 8.8 | 128 | 9.0 | 1100 | 11.0 | 160 | 11.2 |

* Values in psi and kg/cm2 rounded to the nearest practical unit.

SIZE EQUIVALENCY

| mm dimension | Equivalent size |
|--------------|-----------------|
| 250/80R16 | 7.5R16 |
| 340/80R18 | 12.5R18 |
| 360/80R20 | 14.5R20 |
| 300/80R24 | 11.2R24 |
| 340/80R24 | 12.4R24 |
| 360/80R24 | 13.6R24 |
| 400/80R24 | 14.9R24 |
| 440/80R24 | 16.9R24 |
| 360/80R28 | 13.6R28 |
| 400/80R28 | 14.9R28 |
| 440/80R28 | 16.9R28 |
| 440/80R30 | 16.9R30 |
| 480/80R30 | 18.4R30 |
| 440/80R34 | 16.9R34 |
| 480/80R34 | 18.4R34 |
| 480/80R38 | 18.4R38 |
| 540/80R38 | 20.8R38 |
| 620/80R42 | N.A. |
| 270/75R15 | N.A. |
| 250/75R16 | N.A. |
| 500/70R24 | 19.5LR24 |

TIRE STRUCTURES



RADIAL TIRE

The tire carcass is stabilized by an inextensible circumferential belt

The ply cords are laid substantially at 90° to the centerline of the tread

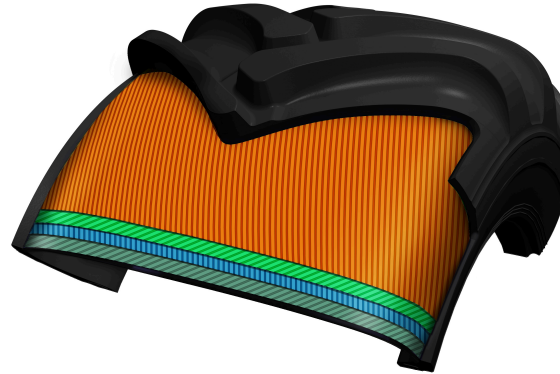

DIAGONAL (OR BIAS PLY) TIRE

The ply cords are laid at alternate angles substantially less than 90° to the centerline of the tread

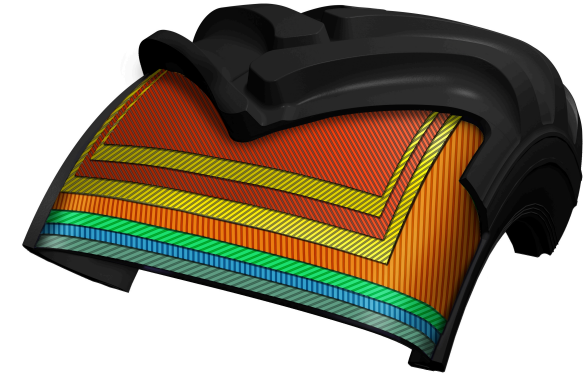

BIAS BELTED

The tire carcass is stabilized by an inextensible circumferential belt

Tire structure of diagonal tire

INFLATION PRESSURE

CHOOSING THE RIGHT INFLATION PRESSURE

MAINTAINING THE PROPER INFLATION PRESSURE

The inflation pressures of tires should be checked carefully at regular intervals. Perform a visual check daily and repeatedly when operating. A slow leak can cause damage to the tire sidewall or lead to tube failure before the under-inflation can be felt in the handling of the machine.

Repairable damage should be repaired immediately in order to help obtain regular tire life. When operating machinery in winter conditions, it should be kept in mind that when temperatures decrease, so do tire inflation pressures. Consequently, when inflating a tire indoors in winter, it should be inflated slightly over the recommended pressure. The diagram below should prove of assistance in determining the correct pressure.

GROUND DISTURBANCE

Ground disturbance is more pronounced when operating in soft soil conditions. When the tire gets in contact with the ground on a hard surface, it is the tire that gets depressed, whereas when operating on soft soil, the ground gets depressed. The inflation pressure should be less than the ground pressure between the ground and the tire, in case approx. 55 kPa, for it to reduce the depth of the footprint.

Consequently, it is not advisable to reduce tire inflation pressures in order to improve the machine's footprint, as it has a negative impact on the tire's service life. The use of wider tires and tires with VF technology will serve this

THE RELATIONSHIP BETWEEN TIRE INFLATION PRESSURE AND AIR TEMPERATURE

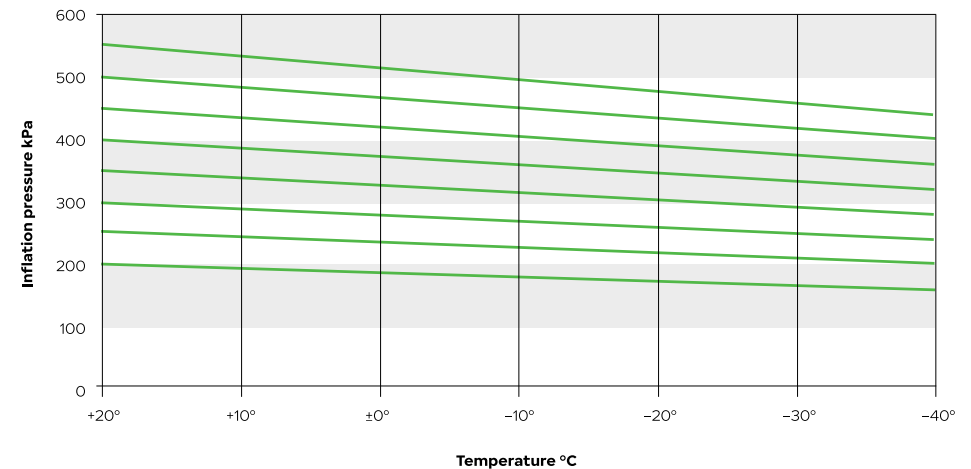

purpose better.

Nokian Tyres Soil King VF

LIQUID AND SALT BALLASTING

- Liquid ballasting is used to increase machine stability
- It is recommended to use professional tire outlets to carry out the filling procedure
- Special equipment and water permeable valves are required
- In liquid and salt ballasting, use tubes to prevent rims from rusting

Note! If a filler other than liquid is used (i.e. polyurethane), tire warranty does not apply.

Note! Do not use liquids or innertubes in tires fitted with sensors. The sensor warranty does not apply in case of damage caused by liquids or accessories such as innertubes.

WATER BALLASTING

75 % of the tire volume is filled. Amounts listed in the table below.

WATER AND SALT BALLASTING

The addition of salt will prevent freezing. 75% of the tire volume is filled with the proportions given in the table below. The salt / water solution is calculated at a temperature of -30 °C / -22°F. Normal commercial salt (CaCl₂), 77% purity, is used.

Any additional salt will not necessarily dissolve in water.

The remaining tire volume is inflated to the recommended inflation pressure.

Notice! Since tire has air only 25% of the original volume, regular inflation pressure checks are highly recommended.

TRACTOR AND LOADER TIRES FOR WINTER APPLICATION

Tractor and loader tyres are currently excluded from the scope of winter performance testing and certification established and enforced by supranational authorities UN ECE and European Commission.

In order to acquire the 3PMSF (Three-Peak Mountain Snowflake) “Alpine Symbol,” a tyre must be within the scope of UN ECE Regulation 117:

Tyre type: C1 (passenger car tyres), C2, C3 (truck and bus tyres)

- Vehicle type: M, N, or O (car, bus, truck, trailers)
- Tyre speed rating: F (80 km/h) or more
- Rim diameter: More than 10” and below 25”

In the absence of specific regulations, it is up to the manufacturer to choose to verify the winter performance properties of their tractor and loader tyres marketed for winter applications through their own test procedures.

The Nokian Heavy Tyres products developed and tested for high performance in winter applications include

Nokian Tyres TRI2, Nokian Tyres Hakkapeliitta TRI, and Nokian Tyres Hakkapeliitta Loader.

The marking “M+S” has been adopted by Nokian Tyres as an indication of suitability for winter applications based on winter testing.



Features of Nokian Heavy Tyres products for winter applications

- The materials used in the casing of the tyre withstand and maintain performance in sub-zero temperatures.
- The tread pattern material used in the tyres is developed for high friction on ice and snow, even in sub-zero temperatures.
- The pattern consists of multiple pattern elements with edges to enhance longitudinal and lateral grip for acceleration, braking, and steering on snow. In the case of Nokian Tyres Hakkapeliitta TRI and Hakkapeliitta Loader, the pattern also includes siping up to 80% of the pattern depth.

Winter performance testing for these tyres has been conducted at the Nokian Tyres Winter Testing Center in Ivalo, Finland.

NON-SKID CHAINS

Nowadays, the general tendency is to work increasingly without chains. This in turn places additional demands on forestry tire selection in order to ensure access to difficult terrain while, at the same time, minimising ground disturbance. In practise, however, there are situations when the use of chains cannot be avoided. In such cases, it is important to pay attention to some basic considerations.

USE OF CHAINS

Before installing new chains, it is recommended that they be inspected for sharp edges or welding burrs. When installing chains on a tire, it is important to ensure that the chains are sufficiently tight. Chains that are too loose can slip on the tire causing excessive wear.

Checking the functioning of old and worn chains is recommended from time to time as well. It is important to check that no chain rings are broken and that none of these individual rings have turned, so that their calks cut into the tire. The same damage can occur with severely worn and thus overstretched chains.



TRACKS

Track manufacturers give their recommendations in slightly different ways. The practice, that is becoming increasingly common, is where track manufacturers specify their products according to the tire manufacturer, the tread design and the tire size. The minimum requirement is that the track manufacturer provide the tire size and the tread design for each track type.

When acquiring tracks, it is extremely important

for the user to select the correct track type which is suitable for the tire and that the operating pressure, in particular, meets the recommendations of track manufacturers. When selecting tracks, it is recommended that the user contacts the track manufacturer.

When using tracks the correct pressure level is the maximum permitted inflation pressure for each tire size.

RECOMMENDED INFLATION PRESSURES WHEN USING TRACKS

| Tire size | PR | LI / SS | kPa | psi |
|-------------|----|-----------------|-----|-----|
| 500/60-22.5 | 16 | | 430 | 62 |
| 600/50-22.5 | 16 | 151 A8 / 158 A2 | 430 | 62 |
| 700/45-22.5 | 16 | | 390 | 57 |
| 710/40-22.5 | 16 | 154 A8 / 161 A2 | 390 | 57 |
| 710/40-24.5 | 20 | 163 A8 / 190 A2 | 550 | 80 |
| 600/55-26.5 | 16 | | 460 | 67 |
| 700/45-26.5 | 16 | | 460 | 67 |
| 710/45-26.5 | 16 | 161 A8 / 168 A2 | 460 | 67 |
| 600/55-26.5 | 20 | 165 A8 / 172 A2 | 550 | 80 |
| 650/65-26.5 | 20 | 172 A8 / 179 A2 | 550 | 80 |
| 700/50-26.5 | 20 | | 550 | 80 |
| 710/45-26.5 | 20 | 168 A8 / 175 A2 | 550 | 80 |
| 750/55-26.5 | 20 | 177 A8 / 184 A2 | 550 | 80 |
| 780/55-26.5 | 20 | 179 A8 / 186 A2 | 550 | 80 |
| 800/40-26.5 | 20 | 170 A8 / 177 A2 | 550 | 80 |
| 650/45R24.5 | | 161 A8 / 168 A2 | 550 | 80 |
| 600/55R26.5 | | 165 A8 / 172 A2 | 550 | 80 |
| 710/45R26.5 | | 168 A8 / 175 A2 | 550 | 80 |
| 800/50R26.5 | | 180 A8 / 187 A2 | 550 | 80 |

Notice! Contact the track manufacturer for the correct track for your tire.



RIMS

STANDARDS

Tires are designed for use on rims that meet the industry standards. It is the responsibility of the vehicle manufacturers and vehicle users that rims used comply with these standards.

The right tire and rim combination defined in these standards guarantees a proper mounting and fit of tire on the rim. Standards manuals give the proper rim dimensions and the right rim contours for use on each tire size and service condition.

Rims and wheels may be stamped with maximum load and maximum cold inflation ratings. If these are not identified consult the rim and wheel manufacturer for rim and wheel capacities for the intended service.



Tire and rim standards manuals.

| | |
|--------------|--|
| TRA | The Tire and Rim Association Inc. |
| ETRTO | The European Tire and Rim Technical Organisation |
| JATMA | The Japan Automobile Tire Manufacturers Association Inc. |
| STRO | The Scandinavian Tire & Rim Organisation |

INFORMATION NEEDED FOR DEFINING A WHEEL

A wheel consists of a rim and a disc. Rim contours are standardised and differ from each other according to the service type. Wheel discs are characterised by the offset position, attachment and centre hole.

To define a wheel for a certain application, the following information is needed by the wheel manufacturer:

INFORMATION FROM THE TIRE MANUFACTURER:

1. Tire size, loading requirements and service type
2. Nominal width code (inch)
3. Diameter code (inch)
4. Tubeless or tube-type tire

With this tire information the rim contour can be designed.

INFORMATION FROM THE VEHICLE MANUFACTURER:

5. Offset
6. Disc centre hole
7. Attachment (bolt circle diameter, bolt hole size, bolt hole type)
8. Wheel loading and maximum speed requirements
9. Valve hole placement, type of valve preferred and need for valve protection
10. The wheel colour

With this information a standard or a tailored wheel can be defined.

Notice! When in doubt consult rim and wheel manufacturer for confirmation on the strength of the rim/wheel for the intended service.

RIM MARKINGS

Disc wheels and demountable rims shall be marked with the following information:

- a) Rim size designation
- b) Wheel/rim manufacturer (name, symbol or trademark)
- c) date of manufacture
- d) part number or code

Rings shall be marked with the following information:

- a) Identification of rim to which the part may be fitted
- b) Identification of manufacturer
- c) Date of manufacture
- d) Flange height designation (on side rings for EM rims)

Notice! With recommended rim you get the best operational result from your tire. You may use also permitted rim as an alternative.

Notice!
 - indicates multi-piece rim.
 x indicates one-piece rim.

| Rim marking | | | Rim contour | | Nominal diameter code | Special features |
|-----------------|----|-----------------|-------------|---------|-----------------------|--|
| | | | Width code | Profile | | |
| 61/2J x 15 H2 | or | 15 x 61/2J H2 | 6 1/2 | J | 15 | Asymmetrical drop-centre, double hump (H2). (if S=symmetrical) |
| 225 x 750 | | | 7.5 | | 22.5 | |
| 10.00 V -20 | or | 20 - 10.00 V | 10 | V | 20 | |
| DW16L x 26 | or | 26 x SW 16L | 16 | L | 26 | Secondary Well (DW) |
| 8.00TG - 24 SDC | or | 24 - 8.00TG SDC | 8.00 | TG | 24 | Semi-Drop Centre (SDC) |
| 11.25 - 25/2.0 | or | 25 - 11.25/2.0 | 11.25 | | 25 | Flange Height Code (/2.0) |

WHEEL STUD HOLES AND COUNTER SINKS

WHEEL CONNECTION TO THE HUB

The stud/bolt holes in the wheel's center disc together with the center hole define the wheel's connection to the hub. To make sure the wheel is connected centrally, the wheel has two options.

One is to center the wheel via the center hole using a specified tolerance, then typically the bolt/stud holes are straight. This solutions is often used for example in tractors.

The other is to use chamfered bolt/stud holes, which enables the wheel to center itself using the holes geometry. In that case the tolerance of the center hole is slightly larger.

| Bolt Hole Diameters d_1 | Countersink Type | | | |
|---------------------------|-----------------------|--|-------------------------------|--|
| | Spherical Countersink | | Conical countersink | |
| | Sphere Radii - r | Spherical countersink outside diameter - d_2 | Countersink angles - α | Conical countersink outside diameter - d_2 |
| 18 | 16 | 27 | 60 | 22 |
| 20 | 18 | 29 | 90 | 27 |
| 21 | | 32 | | 29 |
| 21.5 | | | | 32 |
| 22 | | | | 35 |
| 24 | | | | |
| 25.4 | | | | |
| 26 | | | | |
| 27 | | | | |

COUNTERSINK TYPE

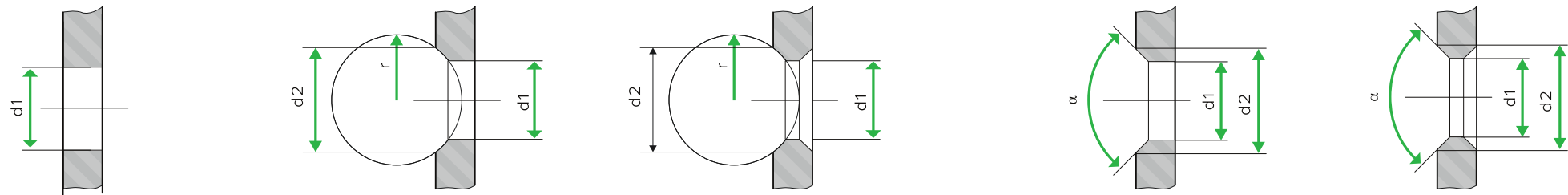

TYPICAL SPHERICAL COUNTERSINK

| Countersink Designation | Bolt Hole Diameter d1 | d2 | sphere R | Countersink Description | EUWA | Inside/Outside/Both |
|-------------------------|-----------------------|----|----------|-------------------------|-----------|---------------------|
| A2 | 21.5 | 27 | 16 | AR/D16-27 | B18 ES 32 | Outside |
| A3 | 27 | 32 | 18 | AR/D18-32 | B22 ES 36 | Outside |
| B2 | 21.5 | 27 | 16 | BR/D16-27 | B18 DS 32 | Both |
| B3 | 27 | 32 | 18 | BR/D-18-32 | B22 DS 36 | Both |

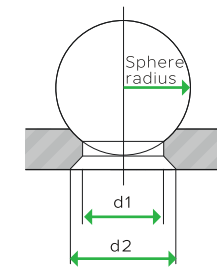
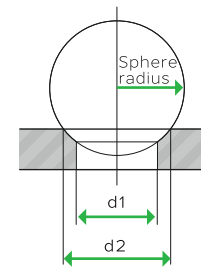

EUWA 3.15 Stud Hole Designation With A Spherical Countersink

| | |
|----|--------------------|
| B | Bolt Centric |
| M | Hub Centric |
| 27 | Stud Hole Diameter |
| I | Inside |
| E | Outside |
| D | Both |
| S | Spherical |
| 36 | Sphere diameter |

Stud hole code Spherical type of stud hole

| | |
|----|----------------------------------|
| B | stud centring |
| M | hub centering / double centering |
| 22 | stud diameter |
| I | counter sink inside |
| E | external |
| D | double side |
| S | spherical |
| 36 | sphere diameter |

Example

| | |
|-------------------------|-----------|
| according to EUWA | |
| countersink external | B22 ES 36 |
| countersink inside | B22 IS 36 |
| countersink designation | A3 |

Example

| | |
|-------------------------|-----------|
| according to EUWA | |
| countersink double side | B22 DS 36 |
| countersink designation | B3 |

TYPICAL CONICAL COUNTERSINK

| Countersink Designation | Bolt Hole Diameter d1 | Conical countersink outside diameter - d2 | Countersink angles - α | Countersink Description | EUWA | Inside/ Outside/ Both |
|-------------------------|-----------------------|---|-------------------------------|-------------------------|------|-----------------------|
| A21 | 21.5 | 27 | 90 | A90-27 | - | Outside |
| B21 | 21.5 | 27 | 90 | B90-27 | - | Both |

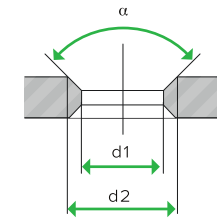
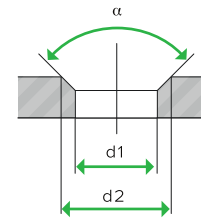

EUWA 3.15 Stud Hole Designation With A Conical Countersink

| | |
|----|--------------------|
| B | Bolt Centric |
| M | Hub Centric |
| 27 | Stud Hole Diameter |
| I | Inside |
| E | Outside |
| D | Both |
| C | Conical |
| 60 | Angle |

Stud hole code Conical type of stud hole

| | |
|----|----------------------------------|
| B | stud centring |
| M | hub centering / double centering |
| 23 | stud diameter |
| I | counter sink inside |
| E | external |
| D | double side |
| C | conical |
| 80 | angle |

Example

| | |
|-------------------------|-----------|
| according to EUWA | |
| countersink external | B23 EC 80 |
| countersink inside | B23 IC 80 |
| countersink designation | A17 |

Example

| | |
|-------------------------|-----------|
| according to EUWA | |
| countersink double side | B23 DC 80 |
| countersink designation | B17 |

CYLINDRICAL (PLAIN STUD HOLES, HUB CENTRIC)

| Bolt Hole Diameter d1 | EUWA |
|-----------------------|------|
| 18 | |
| 20 | |
| 21 | M18 |
| 21.5 | |
| 22 | |
| 24 | M20 |
| 25.4 | |
| 26 | M22 |
| 27 | |

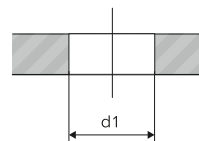

Example

| | |
|-----------------------|-----|
| according to EUWA | |
| cylindrical stud hole | M22 |

RIM CONTOURS

There are mainly two types of rims used with Nokian Heavy Tyres products. Wide well-base and flat-base contour designs.

1. WIDE WELL-BASE (W AND DW)

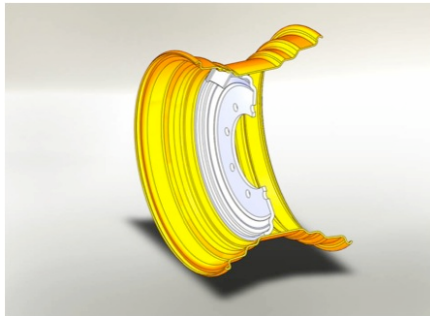

DW rim

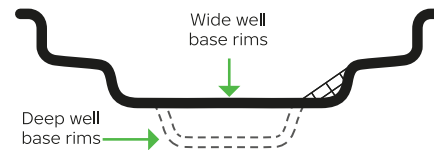

Wide (wide well) and DW (deep well) rim contours

2. FLAT BASE RIMS

Flat base rims are generally of divided construction or equipped with lock rings.



Flat base rim

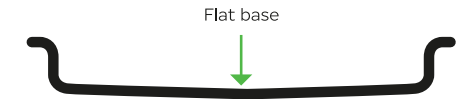

Flat base rim contour

W OR DW?

DW facilitates better the mounting of high PR (stiffer construction) tires. DW rims also have higher strength compared with W rims, due to more bends in the contour shape.

WHEEL (DISC INCLUDED) MAIN DIMENSIONS

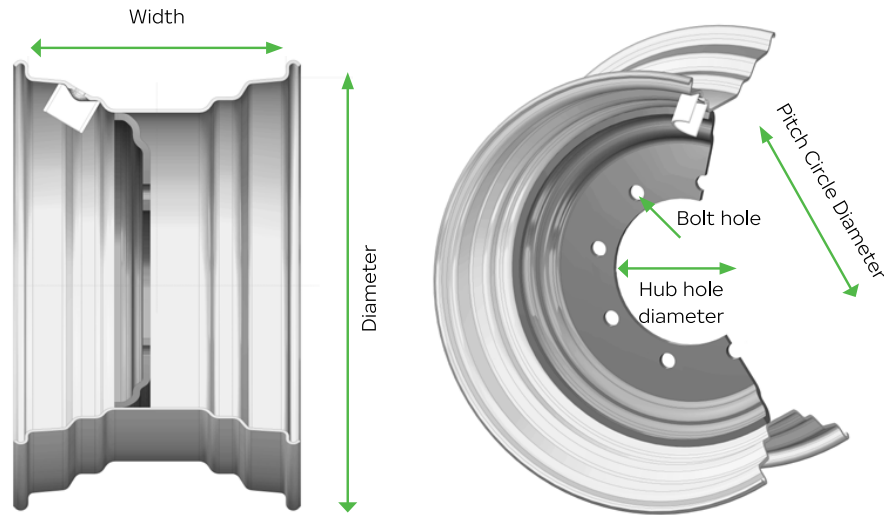

+ OFFSET DECREASES TRACK WIDTH

- OFFSET INCREASES TRACK WIDTH

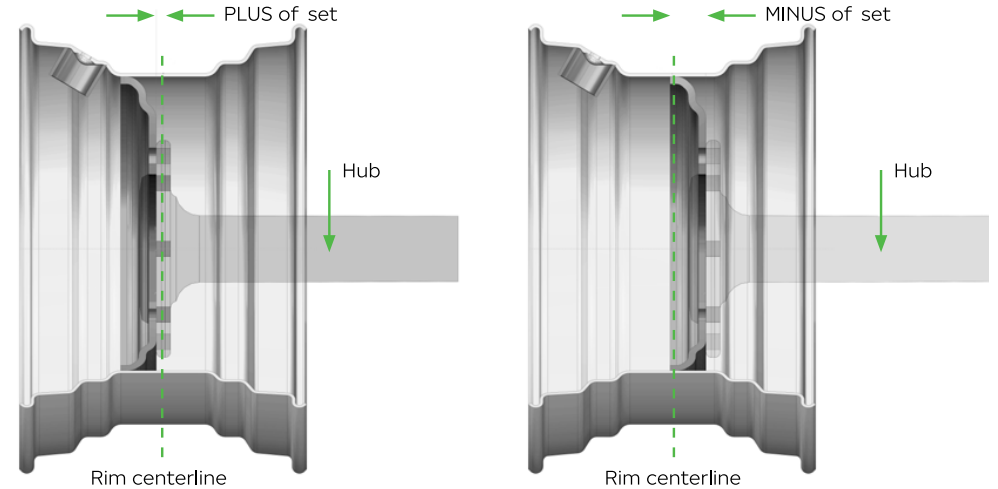

DISC HOLE DEFINITION (MM)

| | | | | |
|-----|-----|------|----|-----------------------------|
| 281 | 335 | 25,4 | 10 | AR18-32 |
| | | | | Countersink |
| | | | | Number of holes |
| | | | | Bolt hole diameter |
| | | | | Pitch circle diameter (PCD) |
| | | | | Hub hole diameter |

Offset is the distance from the rim centerline to the hub mounting surface

+ offset decreases track width

- offset increases track width

WHEEL PARTS / COMPONENTS

SINGLE PIECE WHEEL

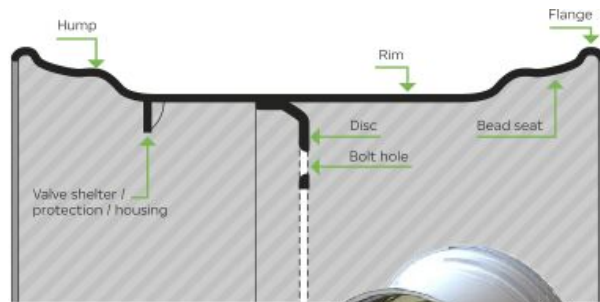

AG wheel with 2 humps (H2)



VALVE PROTECTORS

In tough operating conditions, i.e. forestry a R2" thread valve protector is commonly used. A transparent cap enables the use of LED pressure warning device.



R2" valve protector



Transparent cap for R2"



Other types of valve protectors depending on user preferences



FORESTRY RIMS

EXAMPLES OF TYPICAL FORESTRY RIM SIZES

AG 22.00 x 22.5 All 15° tapered
 AG 24.00 x 24.5
 AG 24.00 x 26.5
 AG 28.00 x 26.5

DW 20 B x 26 All 5° tapered
 DW 25 B x 26
 DW 23 B x 34
 DW 24 B x 34

AG = agricultural rim contour (drop centre rims)

DW = deep well rims

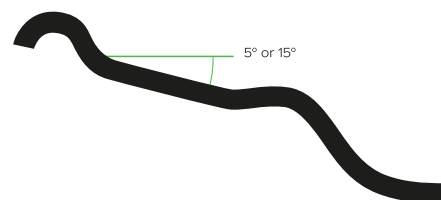

15° tapered in diameter codes xx.5
 5° tapered in diameter codes xx

REINFORCEMENTS

Rims used in professional logging operations are recommended to have contour flange reinforcements. These add load carrying capacity and protect flanges against impacts.



1) Rim diameters 24,5" and larger

Recommendation: Flat bar steel on the outside flange. Round steel / tube edge / long rolled flange on the inside flange.



2) Rim diameters smaller than 24,5"

Recommended reinforcements depending on loading and operating conditions. Types:

- Round steel
- Tube flange edge
- Long rolled flange edge



Forestry rim with flat bar steel reinforcement

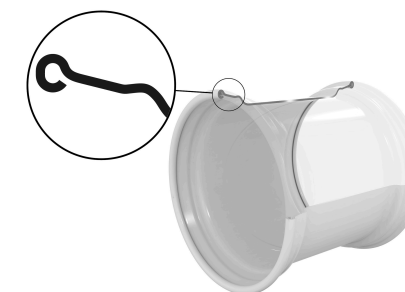

Tube flange edge

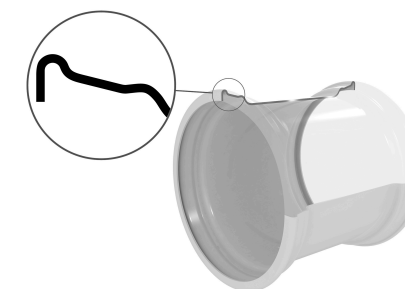

Long rolled flange edge

KNURLING

Knurling has been designed to prevent tire slippage on rim caused by the inherent traction force on the wheel. To produce the desired effect, knurling must extend beyond the surface of the rim bead seat.

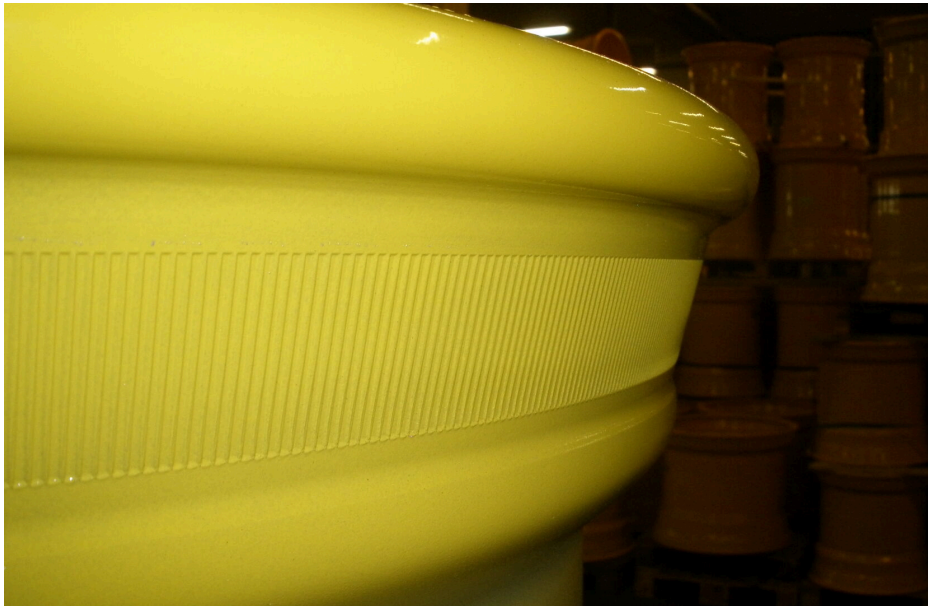

Knurling for tire slippage on rim prevention

Other methods to prevent tire slippage on rim

- Friction paint on bead area
- Paint removed from bead area

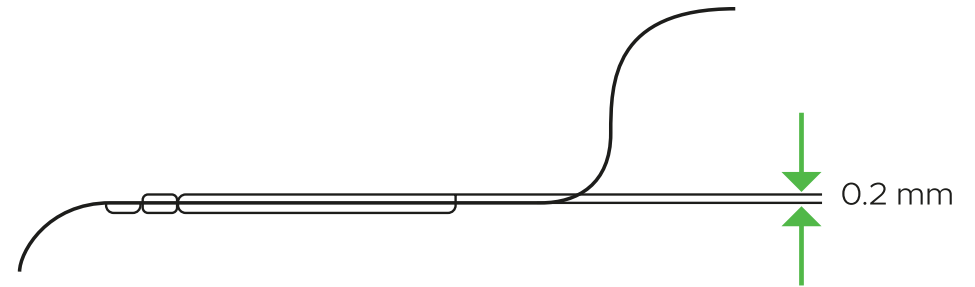

RECOMMENDATIONS FOR KNURLING USE ON 5° TAPERED RIM CONTOURS

| Rim width | Rim Diameter | Rim Diameter 24" and larger |
|-----------------|--------------|-----------------------------|
| 13" and smaller | Upon request | Upon request |
| 14" in smaller | Upon request | Always |

Knurling conditions (ETRTO)

Notice!

For preventing tire slippage on rim:

1. Proper inflation pressure.
2. Use high quality standards fulfilling rims.

TUBELESS FORESTRY RIMS

With the introduction of radial forestry tires(Forest Rider), Nokian Heavy Tyres is able to offer tubeless wheels for forestry.

Advantages:

1. No need for tubes and regular tube maintenance
2. No tube valve break-ups from occasional tire wheel spins in severe high torque conditions.
3. If a wheel spin should occur it has no effect on wheel functionality

A tubeless forestry rim has 3 differences compared with a standart similar contour agricultural rim.

1. Rim flange reinforcements
2. Knurling
3. 15° tapered rims with wider hump dimensioning to accomodate stiffer and wider tire bead area.

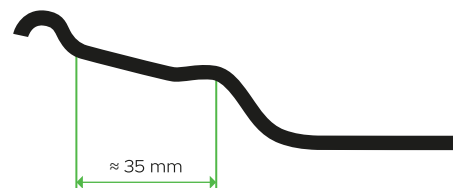

Traditional agricultural rim hump dimensioning

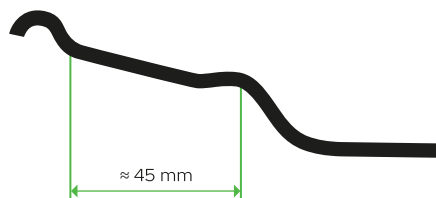

Forestry rim hump dimensioning to accomodate wider tire base

Notice!

Rims with wider hump can be used also in agricultural and forestry trailer tires.
 5° tapered rims don't require humps to perform as tubeless (i.e. 34" Forest Rider sizes).

AGRICULTURAL RIMS

Agricultural rims are TL (tubeless) type. Rim material, rim shape (contour) and material thickness are based on wheel loading requirements.

EXAMPLES OF AGRICULTURAL RIM SIZES

| | |
|-----------------|---|
| 13.00 x 15.5 | All 15° tapered agricultural rim sizes are equipped with humps. |
| 16.00 x 17 | 5° tapered sizes don't require humps for tubeless use. |
| AG 13.00 x 22.5 | |
| AG 20.00 x 26.5 | |
| DW 13 x 24 | |
| DW 15 x 24 | |

INDUSTRIAL AND EM MULTI-PIECE WHEELS

WHEEL PARTS/COMPONENTS



3-piece rim / bead set ring, side ring and lock ring the same component

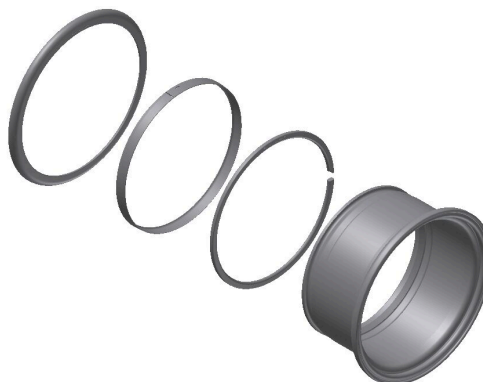

4-piece rim / bead set ring and lock ring the same component



5-piece rim / all parts separate

Notice!

Always check that rim load capacity meets or exceeds tire load capacity. As wheel is a highly stressed component it must be inspected periodically.

Safety and service recommendations for wheels:
www.euwa.org/safety-informations/safety-service

Notice!

Wheel, when disc included. Rim, when no disc included.

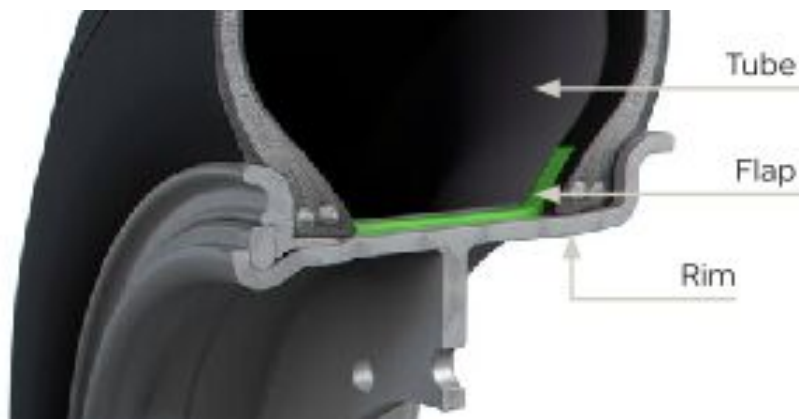

MULTI-PIECE RIMS 20" AND 24"

Generally tube-type wheels, requiring a tube and a flap.

Examples of tire sizes:

- 12.00 - 20
- 14.00 - 24

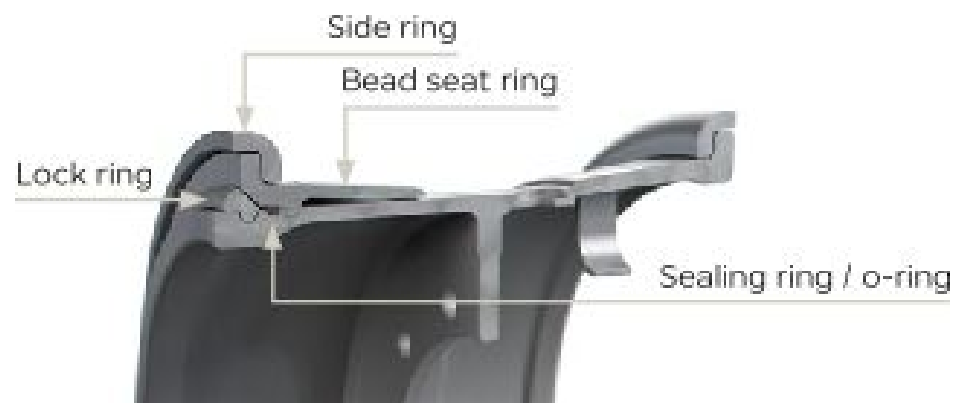

MULTI-PIECE RIMS 25", 29" AND 33"

Generally tubeless wheel, requiring a sealant ring (o-ring).

Examples of tire sizes:

- 17.5 R 25
- 16.00 R 25
- 18.00 - 25
- 18.00 - 33

FLAPS

| Product code | Description | Tire sizes |
|--------------|----------------|--|
| T299520 | FLAP 170-20 | 9.00-20, 10.00-20 |
| T299530 | FLAP 195-20 | 11.00-20, 12.00-20 (rim 8.0) |
| T299537 | FLAP 255-20 | 12.00-20 |
| T299538* | FLAP 260-20 | 14.00-20 |
| T299531* | FLAP 260-24/25 | 12.00-24, 14.00-24, 16.00-24, 16.00-25 |
| T299551 | FLAP 350-25 | 17.5-25, 18.00-25 |
| T299552 | FLAP 500-25 | 23.5-25 |

*) Flap valve hole made afterwards depending on required positioning

O-RINGS

| O-ring code | Nokian Tyres O-ring product code | Rim contours |
|-------------|----------------------------------|---|
| OR-224 | HTOC 00013 | 10.00VA |
| OR-225 | HTOC 00003 | 12.00/1.3, 14.00/1.5 |
| OR-325 | HTOC 00004 | 10.00WA, 11.25/20, 13.00/2.5, 15.00/2.5, 17.00/2.0, 19.50/2.5, 22.00/3.0, 25.00/3.5 |
| OR-329 | HTOC 00008 | 22.00/3.0, 25.00/3.5 |
| OR-333 | HTOC 00011 | 13.00/2.5 |

OR-2XX: OR: O-ring, 2XX: O-ring diameter: 2: 2/8 inch = 6.35 mm / 3: 3/8 inch = 9.53mm

TUBE, FLAP AND O-RING SUITABILITY

| Tire product code | Name | Tube product code | Tube description | Flap product code | Flap description | O-ring* | O-ring description |
|-------------------|-------------------------------|-------------------|------------------------|-------------------|------------------|---------|--------------------|
| T445562 | 9.00-20 16 ARMOR GARD MINE | T52520 | 9.00 -20 TR 175 TUBE | T299520 | FLAP 170-20 | | |
| T445451 | 10.00-20 16 ARMOR GARD | T52620 | 10.00-20 TR 78 TUBE | T299520 | FLAP 170-20 | | |
| T445649 | 10.00-20 16 ARMOR GARD 2 TT | T52620 | 10.00-20 TR 78 TUBE | T299520 | FLAP 170-20 | | |
| T445450 | 11.00-20 16 ARMOR GARD | T52720 | 11.00-20 TR 179 TUBE | T299530 | FLAP 195-20 | | |
| T445459 | 12.00-20 20 ARMOR GARD | T52810 | 12.00-20 V3.02.16 TUBE | T299537 | FLAP 225-20 | | |
| T445449 | 12.00-20 20 ARMOR GARD MINE | T52810 | 12.00-20 V3.02.16 TUBE | T299537 | FLAP 225-20 | | |
| T445544 | 12.00-20 20 MINE KING L-5S TT | T52810 | 12.00-20 V3.02.16 TUBE | T299537 | FLAP 225-20 | | |
| T445617 | 14.00-20 178A2 MINE KING E-4 | T52920 | 14.00-20 TR 274 TUBE | T299537 | FLAP 225-20 | | |

| Tire product code | Name | Tube product code | Tube description | Flap product code | Flap description | O-ring* | O-ring description |
|-------------------|---|-------------------|---|-------------------|------------------|-----------|--------------------|
| T488311 | 14.00-24 28 HTS E-3 TL | T55767 | 14.00-24 TR 1175 TUBE | T299531 | FLAP 260-24/25 | HTOC00004 | OR-325 |
| T445456 | 14.00-24 28 MINE E-3 TL | T55767 | 14.00-24 TR 1175 TUBE | T299531 | FLAP 260-24/25 | HTOC00004 | OR-325 |
| T445471 | 14.00-24 28 RTG TL | T55767 | 14.00-24 TR 1175 TUBE | T299531 | FLAP 260-24/25 | HTOC00004 | OR-325 |
| T493551 | 14.00R25 153A8 GRS TL | T55767 | 14.00-24 TR 1175 TUBE | T299531 | FLAP 260-24/25 | HTOC00013 | OR-224 |
| T445463 | 15.5R25 152B/169A2 LOADER GRIP 2 L-3 TL | T55810 | 16.00-25 TR J1175 BUT | T299551 | FLAP 350-25 | HTOC00003 | OR-225 |
| T488431 | 16.00-25 36 HTS E-4 TL | T55810 | 16.00-25 TR J1175 BUT | | | HTOC00004 | OR-325 |
| T445540 | 17.5-25 24 MINE KING L-5S TL | T55867 | 17.5-25 TR J1175 TUBE | T299551 | FLAP 350-25 | HTOC00003 | OR-225 |
| T445580 | 17.5-25 34 MINE KING L-5S TL | T55867 | 17.5-25 TR J1175 TUBE | T299551 | FLAP 350-25 | HTOC00003 | OR-225 |
| T493560 | 17.5R25 153A8 GRS TL | T55867 | 17.5-25 TR J1175 TUBE | T299551 | FLAP 350-25 | HTOC00003 | OR-225 |
| T445255 | 17.5R25 157V/176A2 LOADER GRIP L-3 TL | T55867 | 17.5-25 TR J1175 TUBE | T299551 | FLAP 350-25 | HTOC00003 | OR-225 |
| T445590 | 17.5R25 176A2/153A8 HAKKAPELIITTA LOADER L-2 TL | T55867 | 17.5-25 TR J1175 TUBE | T299551 | FLAP 350-25 | HTOC00003 | OR-225 |
| T445545 | 18.00-25 32 MINE KING L-5S TL | T55831 | 18.00/ 20.5/ 23.5/ 25/65-25 TR J1175 TUBE | T299551 | FLAP 350-25 | HTOC00004 | OR-325 |
| T445637 | 18.00-25 40 HTS G2 E-4 TL | T55831 | 18.00/ 20.5/ 23.5/ 25/65-25 TR J1175 TUBE | | | HTOC00004 | OR-325 |
| T445638 | 18.00-25 40 HTS G2 L-4S TL | T55831 | 18.00/ 20.5/ 23.5/ 25/65-25 TR J1175 TUBE | | | HTOC00004 | OR-325 |
| T445468 | 18.00-25 40 RTG E-3 TL | T55831 | 18.00/ 20.5/ 23.5/ 25/65-25 TR J1175 TUBE | | | HTOC00004 | OR-325 |
| T445514 | 18.00-33 40 HTS E-4 TL | | | | | HTOC00011 | OR-333 |
| T445458 | 18.00-33 40 HTS L-4S TL | | | | | HTOC00011 | OR-333 |
| T445171 | 20.5R25 168B/186A2 LOADER GRIP L-3 TL | T55831 | 18.00/ 20.5/ 23.5/ 25/65-25 TR J1175 TUBE | T299540 | FLAP 430-25 | HTOC00004 | OR-325 |

| Tire product code | Name | Tube product code | Tube description | Flap product code | Flap description | O-ring* | O-ring description |
|-------------------|---|-------------------|---|-------------------|------------------|-----------|--------------------|
| T445591 | 20.5R25 186A2 HAKKAPELIITTA LOADER L-2 TL | T55831 | 18.00/ 20.5/ 23.5/ 25/65-25 TR J1175 TUBE | T299540 | FLAP 430-25 | HTOC00004 | OR-325 |
| T445223 | 23.5R25 176B/195A2 LOADER GRIP L-3 TL | T55831 | 18.00/ 20.5/ 23.5/ 25/65-25 TR J1175 TUBE | T299552 | FLAP 500-25 | HTOC00004 | OR-325 |
| T445592 | 23.5R25 195A2 HAKKAPELIITTA LOADER L-2 TL | T55831 | 18.00/ 20.5/ 23.5/ 25/65-25 TR J1175 TUBE | T299552 | FLAP 500-25 | HTOC00004 | OR-325 |
| T445546 | 26.5-25 36 MINE KING L-5S TL | | | | | HTOC00004 | OR-325 |
| T445522 | 26.5-25 36 MINE L-3S TL | | | | | HTOC00004 | OR-325 |
| T845483 | 26.5R25 NORDMAN MINE E-4 TL | | | | | HTOC00004 | OR-325 |
| T445547 | 29.5-29 40 MINE KING L-5S TL | | | | | HTOC00008 | OR-329 |
| T845482 | 29.5R25 NORDMAN MINE E-4 TL | | | | | HTOC00004 | OR-325 |

*) O-ring listed is always delivered with the tire

INSPECTIONS ON RIMS

ALLOWED WHEEL RADIAL- / LATERAL RUN-OUTS

Tolerances of the rim radial-/lateral run-out in agricultural and industrial use.

| Nominal rim diameter | STRO radial / lateral | | DIN 7823 radial / lateral | |
|----------------------|-----------------------|-----------|---------------------------|-----------|
| | mm | 32 nds in | mm | 32 nds in |
| 15" - 20" | 2.5 / 2.5 | 3.2 / 3.2 | 3.5 / 3.5 | 4.4 / 4.4 |
| 22" - 28" | 3.5 / 3.5 | 4.4 / 4.4 | 3.5 / 3.5 | 4.4 / 4.4 |
| 30" - 38" | 5.0 / 5.0 | 6.3 / 6.3 | 5.0 / 5.0 | 6.3 / 6.3 |

MANDREL GAUGE

- Tolerance of the mandrel circumference is +/- 1.2mm
- Even a small under-swing on circumference accelerates the wearing of the rim and leads to tire rotation on the rim or bead chafing
- Crossing on circumference can cause a tire damage already when fitting the tire on to the rim

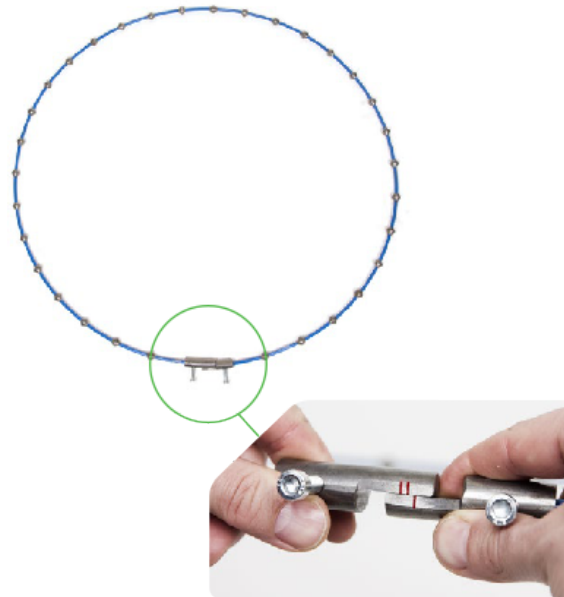

CONTOUR GAUGE

- If the flange is worn out or bent it does not support the bead of the tire and can cause bead chafing and ruin the tire

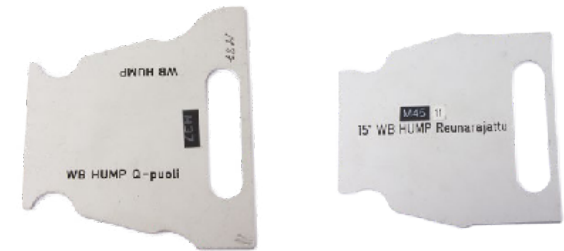

TIRE MOUNTING CLAMPS

Mounting clamp is developed and tested to make mounting easier.



1. Jaw shape is designed to fit with most common reinforced rims. See Suitability table for rims whose compatibility has been tested by Nokian Tyres.
2. Comfortable to handle and doesn't damage the tire
3. Made to last: material thickness 15 mm, screw M20
4. Tommy screws movable pin makes tightening easier

TIRE MOUNTING CLAMPS BY NOKIAN HEAVY TYRES

| | | | |
|--------------------------------|---|----------------------|----------------------|
| AG Single Clamp Mounting | → | | |
| | | Clamp AG Small | |
| AG Dual Clamp Mounting | → | | + |
| | | Clamp AG Big | Clamp AG Small |
| DW/TW/DH Single Clamp Mounting | → | | |
| | | Clamp DW/TW/DH Small | |
| DW/TW Clamp Mounting | → | | + |
| | | Clamp DW/TW Big | Clamp DW/TW/DH Small |
| DH Dual Clamp Mounting | → | | + |
| | | Clamp DW/TW/DH Small | Clamp DH Big |

TECHNICAL SPECIFICATIONS

| Product code | Description | Suitable rim profiles | Suitable tires | Weight (kg) | Dimensions (mm) | Notes |
|--------------|------------------------------------|-----------------------|--|-------------|-----------------|--|
| HTTMC00001 | Tyre mounting clamp AG Big | AG (15°) | Nokian Forestry and Exavator tires fitted on AG 15° profile rims | 5 | 300 x 340 x 40 | Used for AG profile rims in dual clamp mounting as an assistant clamp with smaller HTTMC00002. If rim is with hump design, this clamp fits to WB(Wide Bead) version. |
| HTTMC00002 | Tyre mounting clamp AG Small | AG (15°) | Nokian Forestry, Excavator and Agricultural tires fitted on AG 15° profile rims | 4.3 | 210 x 265 x 40 | Used for AG rims in single clamp mounting and in dual clamp mounting with HTTMC00001. |
| HTTMC00003 | Tyre mounting clamp DW/TW Big | DW / TW (5°) | Nokian Forestry and Agricultural tires fitted on 5° DW / TW profile rims | 8.5 | 440 x 400 x 40 | Used for DW/TW profile rims in dual clamp mounting as an assistant clamp with smaller HTTMC00004. |
| HTTMC00004 | Tyre mounting clamp DW/TW/DH Small | DW / TW / DH (5°) | Nokian Forestry, Skidder and Agricultural tires fitted on 5° DW / TW / DH profile rims | 5.5 | 385 x 350 x 40 | Used for DW, TW and DH profile rims in single clamp mounting and in dual clamp mounting with HTTMC00003 or HTTMC00005. In DH rims if dual steel plate welded in rim flange, this mounting clamp doesn't fit. |
| HTTMC00005 | Tyre mounting clamp DH Big | DH (5°) | Nokian Skidder tires fitted on 5° DW profile rims | 7.9 | 445 x 385 x 40 | Used for DW profile rims in dual clamp mounting as an assistant clamp with smaller HTTMC00004. If dual steel plate welded in rim flange, this mounting clamp doesn't fit. |

For detailed mounting instruction videos, please see:

- » **Excavator tire mounting**
- » **Skidder tire mounting**
- » **CTL tire mounting**

TUBES AND VALVES

TUBE MOUNTING

With properly done mounting, the risk of premature tube failure can be virtually eliminated. A so called dual inflation and the use of talcum powder will help ensure that no air gets trapped between the tire and the tube upon installation.

Use of improper or excessive lubricants can lead to rim slippage. This will cause the valve to tear off, which can cause damage to the entire tire.

For detailed mounting instruction videos, please see:

- » **Excavator tire mounting**
- » **Skidder tire mounting**
- » **CTL tire mounting**

INSTRUCTIONS ON TUBE REPLACEMENT HOURS AND INFLATION PRESSURE CHECK-UPS

REPLACEMENT INSTRUCTION

Severe working conditions:

Replace with new tubes every 5 000 hours.

Less demanding conditions:

Replace with new tubes every 8 000 – 10 000 hours.

This guideline applies when instructed inflation pressures for the given application are used. This guideline applies when inflation pressure check-ups are regular.

INSTRUCTION ON REGULAR INFLATION PRESSURE CHECK-UPS

- To be part of the normal forestry machine service procedure
- To be done every at least every 500 working hours

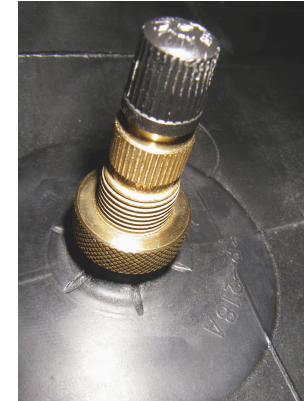

Example of a valve

Notice!

Do not use innertubes in tires fitted with sensors. The sensor warranty does not apply in case of damage caused by accessories such as innertubes.

Notice!

Use only Nokian Tyres tubes for optimal tube life.

Notice!

If pressure instructions and regular inflation pressure check-ups are not applied, tube damages can occur prematurely, even before the minimum 5 000 hour replacement interval.

TIRE CHOICE AND INFLATION PRESSURES BY APPLICATION

KOMATSU

| Harvesters | Forwarders |
|------------|-----------------|
| • 901 | • 825TX |
| • 901XC | • 830.3 |
| • 911 | • 840TX |
| • 931 | • 835 |
| • 931XC | • 840.4 |
| • 941 | • 845 |
| • 951 | • 855.1 / 855.2 |
| • 951XC | • 860.4 |
| | • 865 |
| | • 875 |
| | • 890.3 |
| | • 895 |

CATERPILLAR

| | Forwarders |
|--|------------|
| | • 584 |
| | • 584 HD |

JOHN DEERE

| Harvesters | Forwarders |
|------------|-------------|
| • 1070E | • 810E |
| • 1070G | • 910G |
| • 1170E | • 910/1010G |
| • 1170G | • 1010E |
| • 1270E | • 1010G |
| • 1270G | • 1110G |
| • 1470E | • 1210G |
| • 1470G | • 1510G |
| | • 1910E |
| | • 1910G |

LOGSET

| Harvesters | Forwarders |
|------------|------------|
| • 4H | • 4F |
| • 5H | • 5F |
| • 6H | • 6F |
| • 8H | • 8F |
| • 10H | • 10F |
| | • 12F |

PONSSE

| Harvesters | Forwarders |
|---|--|
| <ul style="list-style-type: none"> • Beaver • Fox • Scorpion • Scorpion King • Cobra • Ergo • Bear | <ul style="list-style-type: none"> • Gazelle • Wisent / Dual • Elk • Bison • Buffalo / Dual • Buffalo / Dual / ADS • Buffalo King • Elephant • Elephan King |

ROTTNE

| Harvesters | Forwarders |
|---|--|
| <ul style="list-style-type: none"> • H8 • H11 • H11c • H14c • H20b • H21d | <ul style="list-style-type: none"> • F10b • F10d • F11d • F13c • F15c • F18 • F20 |







TIGERCAT







| Harvesters | Forwarders |
|--|---|
| <ul style="list-style-type: none"> • 1165 • 1185 | <ul style="list-style-type: none"> • 1055C • 1075C • 1085C |







ECOLOG







| Harvesters | Forwarders |
|---|--|
| <ul style="list-style-type: none"> • 1058H5 • 550F • 550 T-PRO • 560F • 590F • 688F | <ul style="list-style-type: none"> • 750F • 1050F • 1250F • 574F • 584F • 594F |







KOMATSU HARVESTERS

| Machine | Tire size / PR | Tread pattern | | | | | | | Inflation pressure | | | | | | | |
|-----------------|----------------|---|---|---|--|---|---|---|--------------------|-----|------|-----|-----------------------------------|-----|----|--|
| | |  |  |  |  |  |  |  | Front | | Rear | | Max. inflation and track pressure | | | |
| | | F2 | TRS 2 | TRS 2+ | F *Nordman F | Rider | ELS | TRS *Nordman TRS | kPa | psi | kPa | psi | kPa | psi | | |
| 901 | 600/65-34/20 | | | | | | | | | | | | | | | |
| 4 wheels | 600/65-34/24 | | | Front, Rear | | | | | 320 | 46 | 320 | 46 | 400 | | 58 | |
| | 600/65R34 | | | | | Front, Rear | | | 320 | 46 | 320 | 46 | 400 | | 58 | |
| | 700/55-34/20 | | | | | | | | 320 | 46 | 320 | 46 | 360 | | 52 | |
| | 710/55-34/24 | | | Front, Rear | | | | | 320 | 46 | 320 | 46 | 400 | | 58 | |
| | 710/55R34 | | | | | Front, Rear | | | 320 | 46 | 320 | 46 | 400 | | 58 | |
| 901 | 600/50-24.5/20 | | Front | | | | | | 550 | 80 | | | 550 | | 80 | |

| Machine | Tire size / PR | Tread pattern | | | | | | | Inflation pressure | | | | | |
|-----------------|----------------|---|---|---|--|---|---|---|--------------------|-----|------|-----|-----------------------------------|-----|
| | |  |  |  |  |  |  |  | Front | | Rear | | Max. inflation and track pressure | |
| | | F2 | TRS 2 | TRS 2+ | F *Nordman F | Rider | ELS | TRS *Nordman TRS | kPa | psi | kPa | psi | kPa | psi |
| 6 wheels | 650/45R24.5 | | | | | Front | | | 550 | 80 | | | 550 | 80 |
| | 710/40-24.5/20 | Front | Front | | Front | | | 550 | 80 | | | 550 | 80 | |
| | 600/65-34/20 | | | | | | *Rear | | | 320 | 46 | 360 | 52 | |
| | 600/65-34/24 | | | Rear | | | | | | 320 | 46 | 400 | 58 | |
| | 600/65R34 | | | | | Rear | | | | 320 | 46 | 400 | 58 | |
| | 700/55-34/20 | | | | | | *Rear | | | 320 | 46 | 360 | 52 | |
| | 710/55-34/24 | | | Rear | | | | | | 320 | 46 | 400 | 58 | |
| | 710/55R34 | | | | | Rear | | | | 320 | 46 | 400 | 58 | |
| 901XC | 600/50-24.5/20 | | Front, Rear | | | | | 500 | 73 | 320 | 46 | 550 | 80 | |
| 8 wheels | 710/40-24.5/20 | Front, Rear | Front, Rear | | Front, Rear | | | 500 | 73 | 320 | 46 | 550 | 80 | |
| | 800/40-24.5/20 | Front, Rear | Front, Rear | | | | | 500 | 73 | 320 | 46 | 550 | 80 | |
| 911 | 600/65-34/20 | | | | | | *Front, Rear | 320 | 46 | 320 | 46 | 360 | 52 | |
| 4 wheels | 600/65-34/24 | | | Front, Rear | | | | 320 | 46 | 320 | 46 | 400 | 58 | |
| | 600/65R34 | | | | | Front, Rear | | 320 | 46 | 320 | 46 | 400 | 58 | |
| | 700/55-34/20 | | | | | | *Front, Rear | 320 | 46 | 320 | 46 | 360 | 52 | |
| | 710/55-34/24 | | | Front, Rear | | | | 320 | 46 | 320 | 46 | 400 | 58 | |
| | 710/55R34 | | | | | Front, Rear | | 320 | 46 | 320 | 46 | 400 | 58 | |
| 911 | 600/55R26.5 | | | | | Front | | 460 | 67 | | | 550 | 80 | |
| 6 wheels | 600/55-26.5/20 | Front | Front | | Front, *Front | | *Front | 460 | 67 | | | 550 | 80 | |
| | 710/45R26.5 | | | | | Front | | 460 | 67 | | | 550 | 80 | |







| Machine | Tire size / PR | Tread pattern | | | | | | | Inflation pressure | | | | | |
|-----------------|----------------|---|---|---|--|---|---|---|--------------------|-----|------|-----|-----------------------------------|-----|
| | |  |  |  |  |  |  |  | Front | | Rear | | Max. inflation and track pressure | |
| | | F2 | TRS 2 | TRS 2+ | F *Nordman F | Rider | ELS | TRS *Nordman TRS | kPa | psi | kPa | psi | kPa | psi |
| | 710/45-26.5/16 | | | | Front | | | | 460 | 67 | | | 460 | 67 |
| | 710/45-26.5/20 | Front | Front | | Front, *Front | | | *Front | 460 | 67 | | | 550 | 80 |
| | 710/45-26.5/24 | Front | | | Front | | | | 460 | 67 | | | 600 | 87 |
| | 800/40-26.5/20 | Front | Front | | Front | | | | 460 | 67 | | | 550 | 80 |
| | 600/65-34/20 | | | | | | | *Rear | | | 320 | 46 | 360 | 52 |
| | 600/65-34/24 | | | Rear | | | | | | | 320 | 46 | 400 | 58 |
| | 600/65R34 | | | | | Rear | | | | | 320 | 46 | 400 | 68 |
| | 700/55-34/20 | | | | | | | *Rear | | | 320 | 46 | 360 | 52 |
| | 710/55-34/24 | | | Rear | | | | | | | 320 | 46 | 400 | 58 |
| | 710/55R34 | | | | | Rear | | | | | 320 | 46 | 400 | 58 |
| 931 | 600/55R26.5 | | | | | Front | | | 500 | 73 | | | 550 | 80 |
| 6 wheels | 600/55-26.5/20 | Front | Front | | Front, *Front | | | *Front | 500 | 73 | | | 550 | 80 |
| | 710/45R26.5 | | | | | Front | | | 500 | 73 | | | 550 | 80 |
| | 710/45-26.5/20 | Front | Front | | Front, *Front | | | *Front | 500 | 73 | | | 550 | 80 |
| | 710/45-26.5/24 | Front | | | Front | | | | 500 | 73 | | | 600 | 87 |
| | 800/40-26.5/20 | Front | Front | | Front | | | | 500 | 73 | | | 550 | 80 |
| | 600/65-34/20 | | | | | | | *Rear | | | 320 | 46 | 360 | 52 |
| | 600/65-34/24 | | | Rear | | | | | | | 320 | 46 | 400 | 58 |
| | 600/65R34 | | | | | Rear | | | | | 320 | 46 | 400 | 58 |
| | 700/55-34/20 | | | | | | | *Rear | | | 320 | 46 | 360 | 52 |







| Machine | Tire size / PR | Tread pattern | | | | | | | Inflation pressure | | | | | |
|-----------------|----------------|---|---|---|--|---|---|---|--------------------|-----|------|-----|-----------------------------------|-----|
| | |  |  |  |  |  |  |  | Front | | Rear | | Max. inflation and track pressure | |
| | | F2 | TRS 2 | TRS 2+ | F *Nordman F | Rider | ELS | TRS *Nordman TRS | kPa | psi | kPa | psi | kPa | psi |
| | 710/55-34/24 | | | Rear | | | | | | | 320 | 46 | 400 | 58 |
| | 710/55R34 | | | | | Rear | | | | | 320 | 46 | 400 | 58 |
| 931XC | 600/55-26.5/20 | Front, Rear | Front, Rear | | Front, Rear *Front, *Rear | | | *Front, *Rear | 500 | 73 | 400 | 58 | 550 | 80 |
| 8 wheels | 710/45-26.5/20 | Front, Rear | Front, Rear | | Front, Rear *Front, *Rear | | | *Front, *Rear | 500 | 73 | 400 | 58 | 550 | 80 |
| | 710/45-26.5/24 | Front, Rear | Front, Rear | | Front, Rear | | | | 500 | 73 | 400 | 58 | 600 | 87 |
| | 800/40-26.5/20 | Front, Rear | Front, Rear | | Front, Rear | | | | 500 | 73 | 400 | 58 | 550 | 80 |
| 941 | 650/65-26.5/20 | | | | | | Front | Front | 500 | 73 | | | 550 | 80 |
| 6 wheels | 750/55-26.5/20 | | | | Front, *Front | | | Front, *Front | 500 | 73 | | | 550 | 80 |
| | 750/55-26.5/24 | Front | Front | | | | | | 500 | 73 | | | 600 | 87 |
| | 780/55-26.5/20 | | | | Front | | | | 500 | 73 | | | 550 | 80 |
| | 800/50R26.5 | | | | | Front | | | 500 | 73 | | | 550 | 80 |
| | 700/70-34/16 | | | | | | | Rear | | | 260 | 38 | 260 | 38 |
| | 700/70-34/20 | | | | | | | *Rear | | | 320 | 46 | 360 | 52 |
| | 710/70-34/24 | | | Rear | | | | | | | 320 | 46 | 400 | 58 |
| | 710/70R34 | | | | | Rear | | | | | 320 | 46 | 400 | 58 |
| 951XC | 710/45-26.5/24 | Front, Rear | Front, Rear | | | | | | 500 | 73 | 400 | 58 | 600 | 87 |
| 8 wheels | 800/40-26.5/20 | Front, Rear | Front, Rear | | | | | | 500 | 73 | 400 | 58 | 550 | 80 |
| 951 | 710/55-28.5/24 | Front | Front | | | | | | 500 | 73 | | | 600 | 87 |
| 6 wheels | 780/50-28.5/24 | Front | Front | | | | | | 500 | 73 | | | 600 | 87 |







| Machine | Tire size / PR | Tread pattern | | | | | | | Inflation pressure | | | | | |
|---------|----------------|---|---|---|---|---|---|---|--------------------|-----|------|-----|-----------------------------------|-----|
| | |  |  |  |  |  |  |  | Front | | Rear | | Max. inflation and track pressure | |
| | | F2 | TRS 2 | TRS 2+ | F *Nordman F | Rider | ELS | TRS *Nordman TRS | kPa | psi | kPa | psi | kPa | psi |
| | 710/70-34/24 | | | Rear | | | | | | | 320 | 46 | 400 | 58 |
| | 710/70R34 | | | | | Rear | | | | | 320 | 46 | 400 | 58 |







KOMATSU FORWARDERS







| Machine | Tire size / PR | Tread pattern | | | | | | | Inflation pressure | | | | | |
|-----------------|----------------|---|---|---|--|---|---|---|--------------------|-----|------|-----|-----------------------------------|-----|
| | |  |  |  |  |  |  |  | Front | | Rear | | Max. inflation and track pressure | |
| | | F2 | TRS 2 | TRS 2+ | F *Nordman F | Rider | ELS | TRS *Nordman TRS | kPa | psi | kPa | psi | kPa | psi |
| 825TX | 600/50-22.5/20 | Front, Rear | Front, Rear | | | | Front, Rear | Front, Rear | 350 | 51 | 500 | 73 | 550 | 80 |
| 8 wheels | 710/40-22.5/20 | Front, Rear | Front, Rear | | Front, Rear | | Front, Rear | Front, Rear | 350 | 51 | 500 | 73 | 550 | 80 |
| 830.3 | 600/50-22.5/16 | | | | | | Front, Rear | Front, Rear | 350 | 51 | 430 | 62 | 430 | 62 |
| 8 wheels | 600/50-22.5/20 | | | | | | Front, Rear | Front, Rear | 350 | 51 | 500 | 73 | 550 | 80 |
| | 710/40-22.5/16 | | | | Front, Rear | | Front, Rear | Front, Rear | 350 | 51 | 400 | 58 | 400 | 58 |
| 840TX | 600/50R24.5 | | | | | Front, Rear | | | 400 | 58 | 550 | 80 | 550 | 80 |
| 8 wheels | 650/45R24.5 | | | | | Front, Rear | | | 400 | 58 | 550 | 80 | 550 | 80 |
| | 710/40-24.5/20 | Front, Rear | Front, Rear | | Front, Rear | | | | 350 | 51 | 550 | 80 | 550 | 80 |
| 835 | 600/50-24.5/20 | | Front, Rear | | | | | | 400 | 58 | 550 | 80 | 550 | 80 |
| 8 wheels | 650/45R24.5 | | | | | Front, Rear | | | 400 | 58 | 550 | 80 | 550 | 80 |
| | 710/40-24.5/20 | Front, Rear | Front, Rear | | Front, Rear | | | | 350 | 51 | 550 | 80 | 550 | 80 |

| Machine | Tire size / PR | Tread pattern | | | | | | | Inflation pressure | | | | | |
|-----------------|----------------|---|---|---|--|---|---|---|--------------------|-----|------|-----|-----------------------------------|-----|
| | |  |  |  |  |  |  |  | Front | | Rear | | Max. inflation and track pressure | |
| | | F2 | TRS 2 | TRS 2+ | F *Nordman F | Rider | ELS | TRS *Nordman TRS | kPa | psi | kPa | psi | kPa | psi |
| | 800/40-24.5/20 | Front, Rear | Front, Rear | | | | | | 350 | 51 | 550 | 80 | 550 | 80 |
| 840.4 | 600/55-26.5/20 | Front, Rear | Front, Rear | | Front, Rear, *Front, Rear | | | *Front, Rear | 350 | 51 | 550 | 80 | 550 | 80 |
| 8 wheels | 600/55R26.5 | | | | | Front, Rear | | | 350 | 51 | 550 | 80 | 550 | 80 |
| | 710/45R26.5 | | | | | Front, Rear | | | 350 | 51 | 500 | 73 | 550 | 80 |
| | 710/45-26.5/20 | Front, Rear | Front, Rear | | Front, Rear, *Front, Rear | | | *Front, Rear | 350 | 51 | 500 | 73 | 550 | 80 |
| | 710/45-26.5/24 | Front, Rear | | | Front, Rear | | | | 350 | 51 | 500 | 73 | 600 | 87 |
| | 800/40-26.5/20 | Front, Rear | Front, Rear | | Front, Rear | | | | 350 | 51 | 500 | 73 | 550 | 80 |
| 840.4 | 600/55-26.5/20 | Rear | Rear | | Rear, *Rear | | | *Rear | | | 550 | 80 | 550 | 80 |
| 6 wheels | 600/55R26.5 | | | | | Rear | | | | | 550 | 80 | 550 | 80 |
| | 710/45R26.5 | | | | | Rear | | | | | 500 | 73 | 550 | 80 |
| | 710/45-26.5/20 | Rear | Rear | | Rear, *Rear | | | *Rear | | | 500 | 73 | 550 | 80 |
| | 710/45-26.5/24 | Rear | | | Rear | | | | | | 500 | 73 | 600 | 87 |
| | 800/40-26.5/20 | Rear | Rear | | Rear | | | | | | 500 | 73 | 550 | 80 |
| | 600/65-34/20 | | | | | | | *Front | 350 | 51 | | | 360 | 52 |
| | 600/65-34/24 | | | Front | | | | | 350 | 51 | | | 400 | 58 |
| | 600/65R34 | | | | | Front | | | 350 | 51 | | | 400 | 58 |
| | 700/55-34/20 | | | | | | | *Front | 350 | 51 | | | 360 | 52 |
| | 710/55-34/24 | | | Front | | | | | 350 | 51 | | | 400 | 58 |
| | 710/55R34 | | | | | Front | | | 350 | 51 | | | 400 | 58 |





| Machine | Tire size / PR | Tread pattern | | | | | | | Inflation pressure | | | | | |
|----------------------|----------------|---|---|---|--|---|---|---|--------------------|-----|------|-----|-----------------------------------|-----|
| | |  |  |  |  |  |  |  | Front | | Rear | | Max. inflation and track pressure | |
| | | F2 | TRS 2 | TRS 2+ | F *Nordman F | Rider | ELS | TRS *Nordman TRS | kPa | psi | kPa | psi | kPa | psi |
| 845 | 600/55-26.5/20 | Front, Rear | Front, Rear | | Front, Rear, *Front, Rear | | | *Front, Rear | 350 | 51 | 550 | 80 | 550 | 80 |
| 8 wheels | 600/55R26.5 | | | | | Front, Rear | | | 350 | 51 | 550 | 80 | 550 | 80 |
| | 710/45R26.5 | | | | | Front, Rear | | | 350 | 51 | 500 | 73 | 550 | 80 |
| | 710/45-26.5/20 | Front, Rear | Front, Rear | | Front, Rear, *Front, Rear | | | *Front, Rear | 350 | 51 | 500 | 73 | 550 | 80 |
| | 710/45-26.5/24 | Front, Rear | | | Front, Rear | | | | 350 | 51 | 500 | 73 | 600 | 87 |
| | 800/40-26.5/20 | Front, Rear | Front, Rear | | Front, Rear | | | | 350 | 51 | 500 | 73 | 550 | 80 |
| 855.1 / 855.2 | 710/45R26.5 | | | | | Front, Rear | | | 400 | 58 | 550 | 80 | 550 | 80 |
| 8 wheels | 710/45-26.5/20 | Front, Rear | Front, Rear | | Front, Rear, *Front, Rear | | | *Front, Rear | 400 | 58 | 550 | 80 | 550 | 80 |
| | 710/45-26.5/24 | Front, Rear | | | Front, Rear | | | | 400 | 58 | 550 | 80 | 600 | 87 |
| | 800/40-26.5/20 | Front, Rear | Front, Rear | | Front, Rear | | | | 400 | 58 | 550 | 80 | 550 | 80 |
| 855.1 / 855.2 | 710/45R26.5 | | | | | Rear | | | | | 550 | 80 | 550 | 80 |
| 6 wheels | 710/45-26.5/20 | Rear | Rear | | Rear, *Rear | | | *Rear | | | 550 | 80 | 550 | 80 |
| | 710/45-26.5/24 | Rear | | | Rear | | | | | | 550 | 80 | 600 | 87 |
| | 800/40-26.5/20 | Rear | Rear | | Rear | | | | | | 550 | 80 | 550 | 80 |
| | 600/65-34/20 | | | | | | | *Front | 350 | 51 | | | 360 | 52 |
| | 600/65-34/24 | | | Front | | | | | 350 | 51 | | | 400 | 58 |
| | 600/65R34 | | | | | Front | | | 350 | 51 | | | 400 | 58 |
| | 700/55-34/20 | | | | | | | *Front | 350 | 51 | | | 360 | 52 |

| Machine | Tire size / PR | Tread pattern | | | | | | | Inflation pressure | | | | | |
|-----------------|----------------|---|---|---|--|---|---|---|--------------------|-----|------|-----|-----------------------------------|-----|
| | |  |  |  |  |  |  |  | Front | | Rear | | Max. inflation and track pressure | |
| | | F2 | TRS 2 | TRS 2+ | F *Nordman F | Rider | ELS | TRS *Nordman TRS | kPa | psi | kPa | psi | kPa | psi |
| | 710/55-34/24 | | | Front | | | | | 350 | 51 | | | 400 | 58 |
| | 710/55R34 | | | | | Front | | | 350 | 51 | | | 400 | 58 |
| 860.4 | 710/45-26.5/20 | Front, Rear | Front, Rear | | Front, Rear, *Front, Rear | | | *Front, Rear | 400 | 58 | 550 | 80 | 550 | 80 |
| 8 wheels | 710/45-26.5/24 | Front, Rear | | | Front, Rear | | | | 400 | 58 | 550 | 80 | 600 | 87 |
| | 710/45R26.5 | | | | | Front, Rear | | | 400 | 58 | 550 | 80 | 550 | 80 |
| | 800/40-26.5/20 | Front, Rear | Front, Rear | | Front, Rear | | | | 400 | 58 | 550 | 80 | 550 | 80 |
| 860.4 | 710/45-26.5/20 | Rear | Rear | | Rear, *Rear | | | *Rear | | | 550 | 80 | 550 | 80 |
| 6 wheels | 710/45-26.5/24 | Rear | | | Rear | | | | | | 600 | 87 | 600 | 87 |
| | 710/45R26.5 | | | | | Rear | | | | | 550 | 80 | 550 | 80 |
| | 800/40-26.5/20 | Rear | Rear | | Rear | | | | | | 550 | 80 | 550 | 80 |
| | 600/65-34/20 | | | | | | | *Front | 350 | 51 | | | 360 | 52 |
| | 600/65-34/24 | | | Front | | | | | 350 | 51 | | | 400 | 58 |
| | 600/65R34 | | | | | Front | | | 350 | 51 | | | 400 | 58 |
| | 700/55-34/20 | | | | | | | *Front | 350 | 51 | | | 360 | 52 |
| | 710/55-34/24 | | | Front | | | | *Front | 350 | 51 | | | 400 | 58 |
| | 710/55R34 | | | | | Front | | | 350 | 51 | | | 400 | 58 |
| 865 | 710/45-26.5/20 | Front, Rear | Front, Rear | | Front, Rear, *Front, Rear | | | *Front, Rear | 400 | 58 | 550 | 80 | 550 | 80 |
| 8 wheels | 710/45-26.5/24 | Front, Rear | | | Front, Rear | | | | 400 | 58 | 600 | 87 | 600 | 87 |
| | 710/45R26.5 | | | | | Front, Rear | | | 400 | 58 | 550 | 80 | 550 | 80 |







| Machine | Tire size / PR | Tread pattern | | | | | | | Inflation pressure | | | | | |
|-----------------|----------------|---|---|---|--|---|---|---|--------------------|-----|------|-----|-----------------------------------|-----|
| | |  |  |  |  |  |  |  | Front | | Rear | | Max. inflation and track pressure | |
| | | F2 | TRS 2 | TRS 2+ | F *Nordman F | Rider | ELS | TRS *Nordman TRS | kPa | psi | kPa | psi | kPa | psi |
| | 800/40-26.5/20 | Front, Rear | Front, Rear | | Front, Rear | | | | 400 | 58 | 550 | 80 | 550 | 80 |
| 865 | 710/45-26.5/20 | Rear | Rear | | Rear, *Rear | | | *Rear | | | 550 | 80 | 550 | 80 |
| 6 wheels | 710/45-26.5/24 | Rear | | | Rear | | | | | | 600 | 87 | 600 | 87 |
| | 710/45R26.5 | | | | | Rear | | | | | 550 | 80 | 550 | 80 |
| | 800/40-26.5/20 | Rear | Rear | | Rear | | | | | | 550 | 80 | 550 | 80 |
| | 600/65-34/20 | | | | | | | *Front | 350 | 51 | | | 360 | 52 |
| | 600/65-34/24 | | | Front | | | | | 350 | 51 | | | 400 | 58 |
| | 600/65R34 | | | | | Front | | | 350 | 51 | | | 400 | 58 |
| | 700/55-34/20 | | | | | | | *Front | 350 | 51 | | | 360 | 52 |
| | 710/55-34/24 | | | Front | | | | | 350 | 51 | | | 400 | 58 |
| | 710/55R34 | | | | | Front | | | 350 | 51 | | | 400 | 58 |
| 875 | 710/45-26.5/20 | Front, Rear | Front, Rear | | Front, Rear | | | | 400 | 58 | 550 | 80 | 550 | 80 |
| 8 wheels | 710/45-26.5/24 | Front, Rear | | | Front, Rear | | | | 400 | 58 | 600 | 87 | 600 | 87 |
| | 800/40-26.5/20 | Front, Rear | Front, Rear | | Front, Rear | | | | 400 | 58 | 550 | 80 | 550 | 80 |
| 875 | 710/45-26.5/20 | Rear | Rear | | Rear | | | | | | 550 | 80 | 550 | |
| 6 wheels | 710/45-26.5/24 | Rear | | | Rear | | | | | | 600 | 87 | 600 | |
| | 800/40-26.5/20 | Rear | Rear | | Rear | | | | | | 550 | 80 | 550 | |
| | 700/55-34/20 | | | | | | | *Front | 350 | 51 | | | 360 | |
| | 710/55-34/24 | | | Front | | | | | 350 | 51 | | | 400 | |
| | 710/55R34 | | | | | Front | | | 350 | 51 | | | 400 | |







| Machine | Tire size / PR | Tread pattern | | | | | | | Inflation pressure | | | | | |
|----------------------|----------------|---|---|---|--|---|---|---|--------------------|-----|------|-----|-----------------------------------|-----|
| | |  |  |  |  |  |  |  | Front | | Rear | | Max. inflation and track pressure | |
| | | F2 | TRS 2 | TRS 2+ | F *Nordman F | Rider | ELS | TRS *Nordman TRS | kPa | psi | kPa | psi | kPa | psi |
| 890.3 | 750/55-26.5/20 | | | | Front, Rear | | | Front, Rear | 450 | 65 | 550 | 80 | 550 | 80 |
| 8 wheels | 750/55-26.5/24 | Front, Rear | Front, Rear | | | | | | 450 | 65 | 600 | 87 | 600 | 87 |
| | 780/55-26.5/20 | | | | Front, Rear | | | | 450 | 65 | 550 | 80 | 550 | 80 |
| | 800/50R26.5 | | | | | Front, Rear | | | 450 | 65 | 550 | 80 | 550 | 80 |
| 890.3 | 750/55-26.5/20 | | | | Rear, *Rear | | | Rear, *Rear | | | 550 | 80 | 550 | 80 |
| 6 wheels | 750/55-26.5/24 | Rear | Rear | | | | | | | | 600 | 87 | 600 | 87 |
| | 780/55-26.5/20 | | | | Rear | | | | | | 550 | 80 | 550 | 80 |
| | 800/50R26.5 | | | | | Rear | | | | | 550 | 80 | 550 | 80 |
| | 700/70-34/16 | | | | | | | Front | 260 | 38 | | | 260 | 38 |
| | 700/70-34/20 | | | | | | | *Front | 350 | 51 | | | 360 | 52 |
| | 710/70-34/24 | | | Front | | | | | 350 | 51 | | | 400 | 58 |
| | 710/70R34 | | | | | Front | | | 350 | 51 | | | 400 | 58 |
| 895, 8 wheels | 780/50-28.5/24 | Front, Rear | Front, Rear | | | | | | 450 | 65 | 600 | 87 | 600 | 87 |
| 895 | 780/50-28.5/24 | Rear | Rear | | | | | | | | 600 | 87 | 600 | 87 |
| 6 wheels | 710/70-34/24 | | | Front | | | | | 350 | 51 | | | 400 | 58 |
| | 710/70R34 | | | | | Front | | | 350 | 51 | | | 400 | 58 |







CAT FORWARDERS







| Machine | Tire size / PR | Tread pattern | | | | Inflation pressure | | | | | | | |
|-----------------|----------------|---|---|--|---|--------------------|-----|------|-----|-------------|-----|----------------------------------|-----|
| | |  |  |  |  | Front | | Rear | | With tracks | | Max inflation and track pressure | |
| | | F | Rider | ELS | TRS | kPa | psi | kPa | psi | kPa | psi | kPa | psi |
| 584 | 750/55-26.5/20 | Rear | | | Rear | 400 | 58 | 550 | 80 | 550 | 80 | 550 | 80 |
| 6 wheels | 780/55-26.5/20 | Rear | | | | 400 | 58 | 550 | 80 | 550 | 80 | 550 | 80 |
| | 800/50R26.5 | | Rear | | | 400 | 58 | 550 | 80 | 550 | 80 | 550 | 80 |
| | 700/70-34/16 | | | | Front | 260 | 41 | | | 280 | 41 | 260 | 41 |
| 584 8 | 750/55-26.5/20 | Front, Rear | | | Front, Rear | 400 | 58 | 550 | 80 | 550 | 80 | 550 | 80 |
| 8 wheels | 780/55-26.5/20 | Front, Rear | | | | 400 | 58 | 550 | 80 | 550 | 80 | 550 | 80 |
| | 800/50R26.5 | | Front, Rear | | | 400 | 58 | 550 | 80 | 550 | 80 | 550 | 80 |
| 584 HD | 750/55-26.5/20 | Front, Rear | | | Front, Rear | 400 | 58 | 550 | 80 | 550 | 80 | 550 | 80 |
| 8 wheels | 780/55-26.5/20 | Front, Rear | | | | 400 | 58 | 550 | 80 | 550 | 80 | 550 | 80 |
| | 800/50R26.5 | | Front, Rear | | | 400 | 58 | 550 | 80 | 550 | 80 | 550 | 80 |

JOHN DEERE HARVESTERS





| Machine | Tire size / PR | Tread pattern | | | | | | | Inflation pressure | | | | | | |
|-----------------|----------------|---|---|---|--|---|---|---|-----------------------------|-----|------|-----|----------------------------------|-----|----|
| | |  |  |  |  |  |  |  | Front | | Rear | | Max inflation and track pressure | | |
| | | F2 | TRS 2 | TRS 2+ | F *Nordman F | Rider | ELS | TRS *Nordman TRS | kPa | psi | kPa | psi | kPa | psi | |
| 1070G | 650/60-26.5/20 | | | | | | | Front, Rear | Front, Rear | 450 | 65 | 300 | 44 | 550 | 80 |
| 4 wheels | 750/55-26.5/20 | | | | Front, Rear *Front, Rear | | | | Front, Rear *Front, Rear | 450 | 65 | 300 | 44 | 550 | 80 |
| | 750/55-26.5/24 | Front, Rear | Front, Rear | | | | | | | 450 | 65 | 300 | 44 | 600 | 87 |
| | 600/65-34/20 | | | | | | | | *Front, Rear | 320 | 46 | 280 | 41 | 360 | 52 |
| | 600/65-34/24 | | | Front, Rear | | | | | | 320 | 46 | 280 | 41 | 400 | 58 |
| | 600/65R34 | | | | | Front, Rear | | | | 320 | 46 | 280 | 41 | 400 | 58 |
| | 700/55-34/20 | | | | | | | | *Front, Rear | 320 | 46 | 280 | 41 | 360 | 52 |
| | 710/55-34/24 | | | Front, Rear | | | | | | 320 | 46 | 280 | 41 | 400 | 58 |
| | 710/55R34 | | | | | Front, Rear | | | | 320 | 46 | 280 | 41 | 400 | 58 |
| 1070G | 600/50-22.5/16 | | | | | | | Front | | 400 | 58 | | | 430 | 62 |
| 6 wheels | 600/50-22.5/20 | Front | Front | | | | | | | 400 | 58 | | | 550 | 80 |
| | 710/40-22.5/16 | | | | Front | | | | | 400 | 58 | | | 400 | 58 |
| | 710/40-22.5/20 | Front | Front | | | | | | | 400 | 58 | | | 550 | 80 |
| | 650/60-26.5/12 | | | | | | | | Rear | | | 280 | 41 | 280 | 41 |
| | 650/60-26.5/20 | | | | | | | Rear | Rear | | | 300 | 44 | 550 | 80 |
| | 750/55-26.5/20 | Rear | | | Rear, *Rear | | | | Rear, *Rear | | | 300 | 44 | 550 | 80 |
| | 600/65-34/20 | | | | | | | | *Rear | | | 280 | 41 | 360 | 52 |
| | 600/65-34/24 | | | Rear | | | | | | | | 280 | 41 | 400 | 58 |







| Machine | Tire size / PR | Tread pattern | | | | | | | Inflation pressure | | | | | |
|--------------------|----------------|---|---|---|--|---|---|---|--------------------|-----|------|-----|----------------------------------|-----|
| | |  |  |  |  |  |  |  | Front | | Rear | | Max inflation and track pressure | |
| | | F2 | TRS 2 | TRS 2+ | F *Nordman F | Rider | ELS | TRS *Nordman TRS | kPa | psi | kPa | psi | kPa | psi |
| | 600/65R34 | | | | | | | Rear | | | 280 | 41 | 400 | 58 |
| | 700/55-34/20 | | | | | | | | | | 280 | 41 | 360 | 52 |
| | 710/55-34/24 | | | Rear | | | | | | | 280 | 41 | 400 | 58 |
| | 710/55R34 | | | | | | | Rear | | | 280 | 41 | 400 | 58 |
| 1170G 24.5" | 600/50-24.5/20 | | Front | | | | | | 450 | 65 | | | 550 | 80 |
| 6 wheels | 650/45R24.5 | | | | | | | Front | 450 | 65 | | | 550 | 80 |
| | 710/40-24.5/20 | Front | Front | | Front, *Front | | | | 450 | 65 | | | 550 | 80 |
| | 800/40-24.5/20 | Front | Front | | | | | | 450 | 65 | | | 550 | 80 |
| | 600/65-34/20 | | | | | | | | | | 300 | 44 | 360 | 52 |
| | 600/65-34/24 | | | Rear | | | | | | | 300 | 44 | 400 | 58 |
| | 600/65R34 | | | | | | | Rear | | | 300 | 44 | 400 | 58 |
| | 700/55-34/20 | | | | | | | | | | 300 | 44 | 360 | 52 |
| | 710/55-34/24 | | | Rear | | | | | | | 300 | 44 | 400 | 58 |
| | 710/55R34 | | | | | | | Rear | | | 300 | 44 | 400 | 58 |
| 1170G 24.5" | 600/50-24.5 | | Front, Rear | | | | | | 450 | 65 | 400 | 58 | 550 | 80 |
| 8 wheels | 650/45R24.5 | | | | | | | Front | 450 | 65 | 400 | 58 | 550 | 80 |
| | 710/40-24.5/20 | Front, Rear | Front, Rear | | Front, Rear *Front, Rear | | | | 450 | 65 | 400 | 58 | 550 | 80 |
| | 800/40-24.5/20 | Front, Rear | Front, Rear | | | | | | 450 | 65 | 400 | 58 | 550 | 80 |
| 1170G 26.5" | 600/55-26.5/20 | Front | Front | | Front, *Front | | | | 500 | 73 | | | 550 | 80 |









| Machine | Tire size / PR | Tread pattern | | | | | | | Inflation pressure | | | | | |
|-----------------|----------------|---|---|---|--|---|---|---|--------------------|-----|------|-----|----------------------------------|-----|
| | |  |  |  |  |  |  |  | Front | | Rear | | Max inflation and track pressure | |
| | | F2 | TRS 2 | TRS 2+ | F *Nordman F | Rider | ELS | TRS *Nordman TRS | kPa | psi | kPa | psi | kPa | psi |
| 6 wheels | 710/45-26.5/20 | Front | Front | | Front, *Front | | | *Front | 500 | 73 | | | 550 | 80 |
| | 710/45-26.5/24 | Front | | | Front | | | | 500 | 73 | | | 600 | 87 |
| | 800/40-26.5/20 | Front | Front | | Front | | | | 500 | 73 | | | 500 | 73 |
| | 600/65-34/20 | | | | | | | *Rear | | | 300 | 44 | 360 | 52 |
| | 600/65-34/24 | | | Rear | | | | | | | 300 | 44 | 400 | 58 |
| | 600/65R34 | | | | | Rear | | | | | 300 | 44 | 400 | 58 |
| | 700/55-34/20 | | | | | | | *Rear | | | 300 | 44 | 360 | 52 |
| | 710/55-34/24 | | | Rear | | | | | | | 300 | 44 | 400 | 58 |
| | 710/55R34 | | | | | Rear | | | | | 300 | 44 | 400 | 58 |
| 1270G | 600/55-26.5/20 | Front | Front | | Front, *Front | | | *Front | 500 | 73 | | | 550 | 80 |
| 6 wheels | 600/55R26.5 | | | | | Front | | *Front | 500 | 73 | | | 550 | 80 |
| | 710/45-26.5/20 | Front | Front | | Front, *Front | | | *Front | 500 | 73 | | | 550 | 80 |
| | 710/45R26.5 | | | | | Front | | *Front | 500 | 73 | | | 550 | 80 |
| | 710/45-26.5/24 | Front | | | Front | | | | 500 | 73 | | | 600 | 87 |
| | 800/40-26.5/20 | Front | Front | | Front | | | | 500 | 73 | | | 500 | 73 |
| | 600/65-34/20 | | | | | | | *Rear | | | 300 | 44 | 360 | 52 |
| | 600/65-34/24 | | | Rear | | | | | | | 300 | 44 | 400 | 58 |
| | 600/65R34 | | | | | Rear | | | | | 300 | 44 | 400 | 58 |
| | 700/55-34/20 | | | | | | | *Rear | | | 300 | 44 | 360 | 52 |
| 710/55-34/24 | | | Rear | | | | | | | 300 | 44 | 400 | 58 | |









| Machine | Tire size / PR | Tread pattern | | | | | | | Inflation pressure | | | | | |
|-----------------|----------------|---|---|---|--|---|---|---|--------------------|-----|------|-----|----------------------------------|-----|
| | |  |  |  |  |  |  |  | Front | | Rear | | Max inflation and track pressure | |
| | | F2 | TRS 2 | TRS 2+ | F *Nordman F | Rider | ELS | TRS *Nordman TRS | kPa | psi | kPa | psi | kPa | psi |
| | 710/55R34 | | | | | Rear | | | | | 300 | 44 | 400 | 58 |
| 1270G | 600/55-26.5/20 | Front.Rear | Front.Rear | | Front.Rear *Front.Rear | | | *Front.Rear | 500 | 73 | 400 | 58 | 550 | 80 |
| 6 wheels | 600/55R26.5 | | | | | Front.Rear | | | 500 | 73 | 400 | 58 | 550 | 80 |
| | 710/45-26.5/20 | Front.Rear | Front.Rear | | Front.Rear *Front.Rear | | | *Front.Rear | 500 | 73 | 400 | 58 | 550 | 80 |
| | 710/45R26.5 | | | | | Front.Rear | | | 500 | 73 | 400 | 58 | 550 | 80 |
| | 710/45-26.5/24 | Front.Rear | | | Front.Rear | | | | 500 | 73 | 400 | 58 | 600 | 87 |
| | 800/40-26.5/20 | Front.Rear | Front.Rear | | Front.Rear | | | | 500 | 73 | 400 | 58 | 500 | 73 |
| 1470G | 650/65-26.5/20 | | | | | | Front | Front | 500 | 73 | | | 550 | 80 |
| 6 wheels | 750/55-26.5/20 | | | | Front, *Front | | | Front, *Front | 500 | 73 | | | 550 | 80 |
| | 750/55-26.5/24 | Front | Front | | | | | | 500 | 73 | | | 600 | 87 |
| | 780/55-26.5/20 | | | | Front | | | | 500 | 73 | | | 600 | 87 |
| | 710/55-28.5/24 | Front | Front | | Front | | | | 500 | 73 | | | 600 | 87 |
| | 780/50-28.5/24 | Front | Front | | | | | | 500 | 73 | | | 600 | 87 |
| | 700/70-34/16 | | | | | | | Rear | | | 260 | 38 | 260 | 38 |
| | 700/70-34/20 | | | | | | | *Rear | | | 300 | 44 | 360 | 52 |
| | 710/70-34/24 | | | Rear | | | | | | | 300 | 44 | 400 | 58 |
| | 710/70R34 | | | | | Rear | | | | | 300 | 44 | 400 | 58 |







JOHN DEERE FORWARDERS









| Machine | Tire size / PR | Tread pattern | | | | | | Inflation pressure | | | | | |
|------------------------|----------------|---|---|---|--|---|---|---|-----|------|-----|----------------------------------|----|
| | |  |  |  |  |  |  |  | | | | | |
| | | F2 | TRS 2 | TRS 2+ | F *Nordman F | Rider | TRS *Nordman TRS | Front | | Rear | | Max inflation and track pressure | |
| | | | | | | | kPa | psi | kPa | psi | kPa | psi | |
| 810E | 600/50-22.5/20 | Front, Rear | Front, Rear | | | | Front, Rear | 300 | 44 | 500 | 73 | 550 | 80 |
| 8 wheels | 710/40-22.5/16 | | | | Front, Rear | | Front, Rear | 300 | 44 | 400 | 58 | 400 | 58 |
| | 710/40-22.5/20 | Front, Rear | Front, Rear | | | | | 300 | 44 | 500 | 73 | 550 | 80 |
| 910G 22.5" | 600/50-22.5/20 | Front, Rear | Front, Rear | | | | Front, Rear | 300 | 44 | 500 | 73 | 550 | 80 |
| 8 wheels | 710/40-22.5/16 | | | | Front, Rear | | Front, Rear | 300 | 44 | 400 | 58 | 400 | 58 |
| | 710/40-22.5/20 | Front, Rear | Front, Rear | | | | | 300 | 44 | 500 | 73 | 550 | 80 |
| 910/1010G 24.5" | 600/50-24.5 | | Rear | | | | | | | 550 | 80 | 550 | 80 |
| 6 wheels | 650/45R24.5 | | | | | Rear | | | | 550 | 80 | 550 | 80 |
| | 710/40-24.5/20 | Rear | Rear | | Rear | | | | | 500 | 73 | 550 | 80 |
| | 800/40-24.5/20 | Rear | Rear | | | | | | | 500 | 73 | 550 | 80 |
| | 600/65-34/20 | | | | | | *Front | 300 | 44 | | | 360 | 52 |
| | 600/65-34/24 | | | Front | | | | 300 | 44 | | | 400 | 58 |
| | 600/65R34 | | | | | Front | | 300 | 44 | | | 400 | 58 |
| | 700/55-34/20 | | | | | | *Front | 300 | 44 | | | 360 | 52 |
| | 710/55-34/24 | | | Front | | | | 300 | 44 | | | 400 | 58 |









| Machine | Tire size / PR | Tread pattern | | | | | | Inflation pressure | | | | | |
|------------------------|----------------|---|---|---|--|---|---|---|-----|------|-----|----------------------------------|-----|
| | |  |  |  |  |  |  |  | | | | Max inflation and track pressure | |
| | | F2 | TRS 2 | TRS 2+ | F *Nordman F | Rider | TRS *Nordman TRS | Front | | Rear | | kPa | psi |
| | | | | | | | kPa | psi | kPa | psi | kPa | psi | |
| | 710/55R34 | | | | | Front | | | | | 400 | 58 | |
| | 28L-26/26 | | | | | | 300 | 44 | | | 420 | 61 | |
| 910/1010G 24.5" | 600/50-24.5 | | | | | | | | | | | | |
| 8 wheels | 650/45R24.5 | | | | | Front, Rear | 400 | 58 | 550 | 80 | 550 | 80 | |
| | 710/40-24.5/20 | Front, Rear | Front, Rear | | Front, Rear* Front, Rear | | 400 | 58 | 500 | 73 | 550 | 80 | |
| | 800/40-24.5/20 | Front, Rear | Front, Rear | | | | 400 | 58 | 500 | 73 | 550 | 80 | |
| 1010G 26.5" | 600/55-26.5/20 | Front, Rear | Front, Rear | | Front, Rear* Front, Rear | | *Front, Rear | 400 | 58 | 550 | 80 | 550 | 80 |
| 8 wheels | 600/55R26.5 | | | | | Front, Rear | 400 | 58 | 550 | 80 | 550 | 80 | |
| | 710/45-26.5/20 | Front, Rear | Front, Rear | | Front, Rear* Front, Rear | | Front, Rear *Front, Rear | 400 | 58 | 500 | 73 | 550 | 80 |
| | 710/45-26.5/24 | Front, Rear | | | Front, Rear | | | 400 | 58 | 500 | 73 | 600 | 87 |
| | 710/45R26.5 | | | | | Front, Rear | 400 | 58 | 500 | 73 | 550 | 80 | |
| | 800/40-26.5/20 | Front, Rear | Front, Rear | | Front, Rear | | 400 | 58 | 500 | 73 | 500 | 74 | |
| 1010G 26.5" | 600/55-26.5/20 | Rear | Rear | | Rear, *Rear | | *Rear | | | 550 | 80 | 550 | 80 |
| 6 wheels | 600/55R26.5 | | | | | Rear | | | 550 | 80 | 550 | 80 | |
| | 710/45-26.5/20 | Rear | Rear | | Rear, *Rear | | *Rear | | | 500 | 73 | 550 | 80 |

| Machine | Tire size / PR | Tread pattern | | | | | | Inflation pressure | | | | | |
|-----------------|----------------|---|---|---|--|---|---|---|-----|---|-----|----------------------------------|-----|
| | |  |  |  |  |  |  |  | |  | | Max inflation and track pressure | |
| | | F2 | TRS 2 | TRS 2+ | F *Nordman F | Rider | TRS *Nordman TRS | kPa | psi | kPa | psi | kPa | psi |
| | 710/45-26.5/24 | Rear | | | Rear | | | | | 500 | 73 | 550 | 80 |
| | 710/45R26.5 | | | | | Rear | | | | 500 | 73 | 550 | 80 |
| | 800/40-26.5/20 | Rear | Rear | | Rear | | | | | 500 | 73 | 500 | 73 |
| | 600/65-34/20 | | | | | | *Front | 300 | 44 | | | 360 | 52 |
| | 600/65-34/24 | | | Front | | | | 300 | 44 | | | 400 | 58 |
| | 600/65R34 | | | | Front | | | 300 | 44 | | | 400 | 58 |
| | 700/55-34/20 | | | | | | *Front | 300 | 44 | | | 360 | 52 |
| | 710/55-34/24 | | | Front | | | | 300 | 44 | | | 400 | 58 |
| | 710/55R34 | | | | Front | | | 300 | 44 | | | 400 | 58 |
| | 28L-26/26 | | | | | | Front | 300 | 44 | | | 420 | 61 |
| 1110G | 600/55-26.5/20 | Front, Rear | Front, Rear | | Front, Rear *Front, Rear | | *Front, Rear | 400 | 58 | 550 | 80 | 550 | 80 |
| 8 wheels | 600/55R26.5 | | | | | Front, Rear | | 400 | 58 | 550 | 80 | 550 | 80 |
| | 710/45-26.5/20 | Front, Rear | Front, Rear | | Front, Rear *Front, Rear | | Front, Rear *Front, Rear | 400 | 58 | 500 | 73 | 550 | 80 |
| | 710/45-26.5/24 | Front, Rear | | | Front, Rear | | | 400 | 58 | 500 | 73 | 600 | 87 |
| | 710/45R26.5 | | | | | Front, Rear | | 400 | 58 | 500 | 73 | 550 | 80 |
| | 800/40-26.5/20 | Front, Rear | Front, Rear | | Front, Rear | | | 400 | 58 | 500 | 73 | 500 | 73 |







| Machine | Tire size / PR | Tread pattern | | | | | | Inflation pressure | | | | | |
|-----------------|----------------|---|---|---|--|---|---|---|-----|---|-----|----------------------------------|-----|
| | |  |  |  |  |  |  |  | |  | | Max inflation and track pressure | |
| | | F2 | TRS 2 | TRS 2+ | F *Nordman F | Rider | TRS *Nordman TRS | kPa | psi | kPa | psi | kPa | psi |
| 1110G | 600/55-26.5/20 | Rear | Rear | | Rear, *Rear | | *Rear | | | 550 | 80 | 550 | 80 |
| 6 wheels | 600/55R26.5 | | | | | Rear | | | | 550 | 80 | 550 | 80 |
| | 710/45-26.5/20 | Rear | Rear | | Rear, *Rear | | *Rear | | | 500 | 73 | 550 | 80 |
| | 710/45-26.5/24 | Rear | | | Rear | | | | | 500 | 73 | 550 | 80 |
| | 710/45R26.5 | | | | | Rear | | | | 500 | 73 | 550 | 80 |
| | 800/40-26.5/20 | Rear | Rear | | Rear | | | | | 500 | 73 | 500 | 73 |
| | 600/65-34/20 | | | | | | *Front | 300 | 44 | | | 360 | 52 |
| | 600/65-34/24 | | | Front | | | | 300 | 44 | | | 400 | 58 |
| | 600/65R34 | | | | | Front | | 300 | 44 | | | 400 | 58 |
| | 700/55-34/20 | | | | | | *Front | 300 | 44 | | | 360 | 52 |
| | 710/55-34/24 | | | Front | | | | 300 | 44 | | | 400 | 58 |
| | 710/55R34 | | | | | Front | | 300 | 44 | | | 400 | 58 |
| | 28L-26/26 | | | | | | Front | 300 | 44 | | | 420 | 61 |
| 1210G | 600/55-26.5/20 | Front, Rear | Front, Rear | | Front, Rear *Front, Rear | | *Front, Rear | 400 | 58 | 550 | 80 | 550 | 80 |
| 8 wheels | 600/55R26.5 | | | | | Front, Rear | | 400 | 58 | 550 | 80 | 550 | 80 |
| | 710/45-26.5/20 | Front, Rear | Front, Rear | | Front, Rear *Front, Rear | | *Front, Rear | 400 | 58 | 500 | 73 | 550 | 80 |







| Machine | Tire size / PR | Tread pattern | | | | | | Inflation pressure | | | | | |
|-----------------|----------------|---|---|---|--|---|---|--------------------|-----|------|-----|----------------------------------|-----|
| | |  |  |  |  |  |  | Front | | Rear | | Max inflation and track pressure | |
| | | F2 | TRS 2 | TRS 2+ | F *Nordman F | Rider | TRS *Nordman TRS | kPa | psi | kPa | psi | kPa | psi |
| | 710/45-26.5/24 | Front, Rear | | | Front, Rear | | | 400 | 58 | 500 | 73 | 600 | 87 |
| | 710/45R26.5 | | | | | Front, Rear | | 400 | 58 | 500 | 73 | 550 | 80 |
| | 800/40-26.5/20 | Front, Rear | Front, Rear | | Front, Rear | | | 400 | 58 | 500 | 73 | 550 | 80 |
| 1210G | 600/55-26.5/20 | Rear | Rear | | Rear, *Rear | | | | | 550 | 80 | 550 | 80 |
| 6 wheels | 600/55R26.5 | | | | | Rear | | | | 550 | 80 | 550 | 80 |
| | 710/45-26.5/20 | Rear | Rear | | Rear, *Rear | | | | | 500 | 73 | 550 | 80 |
| | 710/45-26.5/24 | Rear | | | Rear | | | | | 500 | 73 | 600 | 87 |
| | 710/45R26.5 | | | | | Rear | | | | 500 | 73 | 550 | 80 |
| | 800/40-26.5/20 | Rear | Rear | | Rear | | | | | 500 | 73 | 550 | 80 |
| | 600/65-34/20 | | | | | | *Front | 300 | 44 | | | 360 | 52 |
| | 600/65-34/24 | | | Front | | | | 300 | 44 | | | 400 | 58 |
| | 600/65R34 | | | | | Front | | 300 | 44 | | | 400 | 58 |
| | 700/55-34/20 | | | | | | *Front | 300 | 44 | | | 360 | 52 |
| | 710/55-34/24 | | | Front | | | | 300 | 44 | | | 400 | 58 |
| | 710/55R34 | | | | | Front | | 300 | 44 | | | 400 | 58 |
| | 28L-26/26 | | | | | | Front | 300 | 44 | | | 420 | 61 |







| Machine | Tire size / PR | Tread pattern | | | | | | Inflation pressure | | | | | |
|-----------------|----------------|---|---|---|--|---|---|---|-----|---|-----|----------------------------------|-----|
| | |  |  |  |  |  |  |  | |  | | Max inflation and track pressure | |
| | | F2 | TRS 2 | TRS 2+ | F *Nordman F | Rider | TRS *Nordman TRS | kPa | psi | kPa | psi | kPa | psi |
| 1510G | 710/45-26.5/20 | Front, Rear | Front, Rear | | Front, Rear | | | | | | | | |
| 8 wheels | 710/45-26.5/24 | Front, Rear | | | Front, Rear | | 400 | 58 | 600 | 87 | 600 | 87 | |
| | 710/45R26.5 | | | | | Front, Rear | 400 | 58 | 550 | 80 | 550 | 80 | |
| | 800/40-26.5/20 | Front, Rear | Front, Rear | | Front, Rear | | 400 | 58 | 550 | 80 | 550 | 80 | |
| 1510G | 710/45-26.5/20 | Rear | Rear | | Rear | | | | 550 | 80 | 550 | 80 | |
| 6 wheels | 710/45-26.5/24 | Rear | | | Rear | | | | 600 | 87 | 600 | 87 | |
| | 710/45R26.5 | | | | | Rear | | | 550 | 80 | 550 | 80 | |
| | 800/40-26.5/20 | | Rear | | Rear | | | | 500 | 73 | 500 | 73 | |
| | 600/65-34/20 | | | | | | *Front | 320 | 46 | | | 360 | 52 |
| | 600/65-34/24 | | | Front | | | | 320 | 46 | | | 400 | 58 |
| | 600/65R34 | | | | | Front | | 320 | 46 | | | 400 | 58 |
| | 700/55-34/20 | | | | | | *Front | 320 | 46 | | | 360 | 52 |
| | 710/55-34/24 | | | Front | | | | 320 | 46 | | | 400 | 58 |
| | 710/55R34 | | | | | Front | | 320 | 46 | | | 400 | 58 |
| 1910G | 750/55-26.5/20 | | | | Front, Rear *Front, Rear | | | | | 550 | 80 | 550 | 80 |
| 8 wheels | 750/55-26.5/24 | Front, Rear | Front, Rear | | | | | 450 | 65 | 600 | 87 | 600 | 87 |

| Machine | Tire size / PR | Tread pattern | | | | | | Inflation pressure | | | | | |
|-----------------|----------------|---|---|---|--|---|---|---|-----|---|-----|----------------------------------|-----|
| | |  |  |  |  |  |  |  | |  | | Max inflation and track pressure | |
| | | F2 | TRS 2 | TRS 2+ | F *Nordman F | Rider | TRS *Nordman TRS | kPa | psi | kPa | psi | kPa | psi |
| | 780/55-26.5/20 | | | | Front, Rear | | | 450 | 65 | 600 | 87 | 600 | 87 |
| | 800/50R26.5 | | | | | Front, Rear | | 450 | 65 | 550 | 80 | 550 | 80 |
| | 710/55-28.5/24 | Front, Rear | Front, Rear | | | | | 500 | 65 | 600 | 87 | 600 | 87 |
| | 780/50-28.5/24 | Front, Rear | Front, Rear | | | | | 450 | 65 | 600 | 87 | 600 | 87 |
| 1910G | 750/55-26.5/20 | | | | Rear, *Rear | | | | | 550 | 80 | 550 | 80 |
| 6 wheels | 750/55-26.5/24 | Rear | Rear | | | | | | | 600 | 87 | 600 | 87 |
| | 780/55-26.5/20 | | | | Rear | | | | | 600 | 87 | 600 | 87 |
| | 800/50R26.5 | | | | | Rear | | | | 550 | 80 | 550 | 80 |
| | 710/55-28.5/24 | Rear | Rear | | | | | | | 600 | 87 | 600 | 87 |
| | 780/50-28.5/24 | Rear | Rear | | | | | | | 600 | 87 | 600 | 87 |
| | 700/70-34/20 | | | | | | *Front | 340 | 49 | | | 360 | 52 |
| | 710/70-34/24 | | | Front | | | | 340 | 49 | | | 400 | 58 |
| | 710/70R34 | | | | | Front | | 340 | 49 | | | 400 | 58 |







LOGSET HARVESTERS







| Machine | Tire size / PR | Tread pattern | | | | | | | Inflation pressure | | | | | | |
|-----------------|----------------|---|---|---|---|---|---|---|--------------------|-----|------|-----|----------------------------------|-----|----|
| | |  |  |  |  |  |  |  | Front | | Rear | | Max inflation and track pressure | | |
| | | F2 | F | Nordman F | TRS 2 | Rider | TRS | Nordman TRS | kPa | psi | kPa | psi | kPa | psi | |
| 4H | 650/60-26.5/12 | | | | | | | Front, Rear | | 240 | 35 | 240 | 41 | 280 | 41 |
| 4 wheels | 750/55-26.5/20 | | Front, Rear | Front, Rear | | | | Front, Rear | Front, Rear | 280 | 41 | 280 | 41 | 550 | 80 |
| | 750/55-26.5/24 | Front, Rear | | | Front, Rear | | | | | 280 | 41 | 280 | 41 | 550 | 80 |
| | 780/55-26.5/20 | | Front, Rear | | | | | | | 280 | 41 | 280 | 41 | 550 | 80 |
| | 600/65-34/20 | | | | | | Front, Rear | | | 280 | 41 | 280 | 41 | 360 | 52 |
| | 600/65R34 | | | | | Front, Rear | | | | 280 | 41 | 280 | 41 | 400 | 58 |
| | 700/55-34/20 | | | | | | Front, Rear | | | 260 | 38 | 280 | 41 | 360 | 52 |
| | 710/55R34 | | | | | Front, Rear | | | | 260 | 38 | 280 | 41 | 400 | 58 |
| 5H | 600/50-22.5/20 | | | | | | | Front | | 430 | 62 | | | 550 | 80 |
| 6 wheels | 710/40-22.5/16 | | Front | | | | | | | 400 | 58 | | | 430 | 62 |
| | 710/40-22.5/20 | Front | Front | | | Rear | | | | 400 | 58 | | | 550 | 80 |
| | 600/65-34/20 | | | | | | | Rear | | | | 280 | 41 | 360 | 52 |
| | 600/65R34 | | | | | Rear | | | | | | 280 | 41 | 400 | 58 |
| | 700/55-34/20 | | | | | | | Rear | | | | 280 | 41 | 360 | 52 |
| | 710/55R34 | | | | | Rear | | | | | | 280 | 41 | 400 | 58 |
| 6H | 600/55-26.5/20 | Front | Front | Front | Front | | | Front | | 550 | 80 | | | 550 | 80 |
| 6 wheels | 600/55R26.5 | | | | | | | Front | | 550 | 80 | | | 550 | 80 |
| | 710/45-26.5/20 | Front | Front | Front | Front | | | Front | | 550 | 80 | | | 550 | 80 |
| | 710/45R26.5 | | | | | Front | | | | 550 | 80 | | | 550 | 80 |

| Machine | Tire size / PR | Tread pattern | | | | | | | Inflation pressure | | | | | |
|-----------------|----------------|---|---|---|---|---|---|---|--------------------|-----|------|-----|----------------------------------|-----|
| | |  |  |  |  |  |  |  | Front | | Rear | | Max inflation and track pressure | |
| | | F2 | F | Nordman F | TRS 2 | Rider | TRS | Nordman TRS | kPa | psi | kPa | psi | kPa | psi |
| | 800/40-26.5/20 | Front | Front | | Front | | | | 550 | 80 | | | 550 | 80 |
| | 600/65-34/20 | | | | | | | Rear | | | 280 | 41 | 360 | 52 |
| | 600/65R34 | | | | | Rear | | | | | 280 | 41 | 400 | 58 |
| | 700/55-34/20 | | | | | | | Rear | | | 280 | 41 | 360 | 52 |
| | 710/55R34 | | | | | Rear | | | | | 280 | 41 | 400 | 58 |
| 8H | 600/55-26.5/20 | Front | Front | Front | Front | | | Front | 550 | 80 | | | 550 | 80 |
| 6 wheels | 600/55R26.5 | | | | | Front | | | 550 | 80 | | | 550 | 80 |
| | 710/45-26.5/20 | Front | Front | Front | Front | | | Front | 550 | 80 | | | 550 | 80 |
| | 710/45R26.5 | | | | | | | | 550 | 80 | | | 550 | 80 |
| | 800/40-26.5/20 | Front | Front | | Front | | | | 550 | 80 | | | 550 | 80 |
| | 600/65-34/20 | | | | | | | Rear | | | 280 | 41 | 360 | 52 |
| | 600/65R34 | | | | | Rear | | | | | 280 | 41 | 400 | 58 |
| | 700/55-34/20 | | | | | | | Rear | | | 280 | 41 | 360 | 52 |
| | 710/55R34 | | | | | Rear | | | | | 280 | 41 | 400 | 58 |
| 10H | 750/55-26.5/20 | | Front | Front | | | Front | Front | 500 | 73 | | | 550 | 80 |
| 6 wheels | 750/55-26.5/24 | Front | | | Front | | | | 500 | 73 | | | 550 | 80 |
| | 780/55-26.5/20 | | Front | | | | | | 500 | 73 | | | 550 | 80 |
| | 710/55-28.5/24 | Front | | | Front | | | | 500 | 73 | | | 600 | 87 |
| | 780/50-28.5/24 | Front | | | Front | | | | 500 | 73 | | | 600 | 87 |
| | 700/70-34/16 | | | | | | Rear | | | | 260 | 38 | 260 | 38 |







| Machine | Tire size / PR | Tread pattern | | | | | | | Inflation pressure | | | | | |
|---------|----------------|---|---|---|---|---|---|---|--------------------|-----|------|-----|----------------------------------|-----|
| | |  |  |  |  |  |  |  | Front | | Rear | | Max inflation and track pressure | |
| | | F2 | F | Nordman F | TRS 2 | Rider | TRS | Nordman TRS | kPa | psi | kPa | psi | kPa | psi |
| | 700/70-34/20 | | | | | | | | | | 300 | 44 | 360 | 52 |
| | 710/70R34 | | | | | Rear | | | | | 300 | 44 | 400 | 58 |







LOGSET FORWARDERS







| Machine | Tire size / PR | Tread pattern | | | | | | | Inflation pressure | | | | | |
|-----------------|----------------|---|---|---|--|---|---|---|--------------------|-----|------|-----|----------------------------------|-----|
| | |  |  |  |  |  |  |  | Front | | Rear | | Max inflation and track pressure | |
| | | F2 | F | Nordman F | TRS 2 | Rider | TRS | Nordman TRS | kPa | psi | kPa | psi | kPa | psi |
| 4F | 600/50-22.5/20 | | | | | | | Front, Rear | 350 | 51 | 500 | 73 | 550 | 80 |
| 8 wheels | 710/40-22.5/16 | | Front, Rear | | | | | | 350 | 51 | 430 | 62 | 430 | 62 |
| | 710/40-22.5/20 | Front, Rear | | | Front, Rear | | | | 350 | 51 | 430 | 62 | 430 | 62 |
| 5F | 600/55-26.5/20 | Front, Rear | Front, Rear | Front, Rear | Front, Rear | | | Front, Rear | 350 | 51 | 550 | 80 | 550 | 80 |
| 8 wheels | 600/55R26.5 | | | | | Front, Rear | | | 350 | 51 | 550 | 80 | 550 | 80 |
| | 710/45-26.5/16 | | Front, Rear | | | | | | 350 | 51 | 460 | 67 | 460 | 67 |
| | 710/45-26.5/20 | Front, Rear | Front, Rear | Front, Rear | Front, Rear | | | Front, Rear | 350 | 51 | 500 | 73 | 550 | 80 |
| | 710/45R26.5 | | | | | Front, Rear | | | 350 | 51 | 500 | 73 | 550 | 80 |
| | 800/40-26.5/20 | Front, Rear | Front, Rear | | Front, Rear | | | | 350 | 51 | 500 | 73 | 550 | 80 |
| 6F | 600/55-26.5/20 | Front, Rear | Front, Rear | Front, Rear | Front, Rear | | | Front, Rear | 350 | 51 | 550 | 80 | 550 | 80 |
| 8 wheels | 600/55R26.5 | | | | | Front, Rear | | | 350 | 51 | 550 | 80 | 550 | 80 |
| | 710/45-26.5/20 | Front, Rear | Front, Rear | Front, Rear | Front, Rear | | | Front, Rear | 350 | 51 | 550 | 80 | 550 | 80 |



| Machine | Tire size / PR | Tread pattern | | | | | | | Inflation pressure | | | | | |
|-----------------------|----------------|---|---|---|--|---|---|---|--------------------|-----|------|-----|----------------------------------|-----|
| | |  |  |  |  |  |  |  | Front | | Rear | | Max inflation and track pressure | |
| | | F2 | F | Nordman F | TRS 2 | Rider | TRS | Nordman TRS | kPa | psi | kPa | psi | kPa | psi |
| | 710/45R26.5 | | | | | Front, Rear | | | 350 | 51 | 550 | 80 | 550 | 80 |
| | 800/40-26.5/20 | Front, Rear | Front, Rear | | Front, Rear | | | 350 | 51 | 500 | 73 | 550 | 80 | |
| 8F | 710/45-26.5/20 | Front, Rear | Front, Rear | Front, Rear | Front, Rear | | | 400 | 58 | 550 | 80 | 550 | 80 | |
| 8 wheels | 710/45-26.5/24 | Front, Rear | | | | Front, Rear | | 400 | 58 | 550 | 80 | 600 | 87 | |
| | 710/45R26.5 | | | | | Front, Rear | | 400 | 58 | 550 | 80 | 550 | 80 | |
| | 800/40-26.5/20 | Front, Rear | Front, Rear | | Front, Rear | | | 400 | 58 | 500 | 73 | 550 | 80 | |
| 10F | 750/55-26.5/20 | | Front, Rear | Front, Rear | | | Front, Rear | 400 | 58 | 550 | 80 | 550 | 80 | |
| 8 wheels | 750/55-26.5/24 | Front, Rear | | | Front, Rear | | | 400 | 58 | 550 | 80 | 600 | 87 | |
| | 780/55-26.5/20 | | Front, Rear | | | | | 400 | 58 | 550 | 80 | 550 | 80 | |
| | 780/50-28.5/24 | Front, Rear | | | Front, Rear | | | 400 | 58 | 600 | 87 | 600 | 87 | |
| 12F - 8 wheels | 780/50-28.5/24 | Front, Rear | | | Front, Rear | | | 450 | 58 | 600 | 87 | 600 | 87 | |







PONSSE HARVESTERS

| Machine | Tire size / PR | Tread pattern | | | | | | | Inflation pressure | | | | | |
|-----------------|----------------|---|---|---|--|---|---|---|--------------------|-----|------|-----|----------------------------------|-----|
| | |  |  |  |  |  |  |  | Front | | Rear | | Max inflation and track pressure | |
| | | F2 | TRS 2 | TRS 2+ | *Nordman F | Rider | ELS | *Nordman TRS | kPa | psi | kPa | psi | kPa | psi |
| Beaver | 600/55-26.5/20 | Front, Rear | Front, Rear | | Front, Rear *Front, Rear | | | *Front, Rear | 380 | 55 | 460 | 67 | 550 | 80 |
| 6 wheels | 600/55R26.5 | | | | | Front, Rear | | | 380 | 55 | 460 | 67 | 550 | 80 |







| Machine | Tire size / PR | Tread pattern | | | | | | | Inflation pressure | | | | | |
|----------------------|----------------|---|---|---|--|---|---|---|--------------------|-----|------|-----|----------------------------------|-----|
| | |  |  |  |  |  |  |  | Front | | Rear | | Max inflation and track pressure | |
| | | F2 | TRS 2 | TRS 2+ | F *Nordman F | Rider | ELS | TRS *Nordman TRS | kPa | psi | kPa | psi | kPa | psi |
| | 710/45-26.5/16 | | | | Front, Rear | | | | 350 | 51 | 460 | 67 | 460 | 67 |
| | 710/45-26.5/20 | Front, Rear | Front, Rear | | Front, Rear *Front, Rear | | | *Front, Rear | 350 | 51 | 460 | 67 | 550 | 80 |
| | 710/45R26.5 | | | | | Front, Rear | | | 350 | 51 | 460 | 67 | 550 | 80 |
| | 800/40-26.5/20 | Front, Rear | Front, Rear | | Front, Rear | | | | 350 | 51 | 460 | 67 | 550 | 80 |
| | 650/65-26.5/20 | | | | | | Front | Front | 350 | 51 | 460 | 67 | 550 | 80 |
| | 750/55-26.5/20 | Front | Front | | Front | | | | 350 | 51 | 460 | 67 | 550 | 80 |
| Fox | 600/55-26.5/20 | Front, Rear | Front, Rear | | Front, Rear *Front, Rear | | | *Front, Rear | 400 | 58 | 460 | 67 | 550 | 80 |
| 8 wheels | 600/55R26.5 | | | | | Front, Rear | | | 400 | 58 | 460 | 67 | 550 | 80 |
| | 710/45-26.5/16 | | | | Front, Rear | | | | 400 | 58 | 460 | 67 | 460 | 67 |
| | 710/45-26.5/20 | Front, Rear | Front, Rear | | Front, Rear *Front, Rear | | | *Front, Rear | 400 | 58 | 460 | 67 | 550 | 80 |
| | 710/45R26.5 | | | | | Front, Rear | | | 400 | 58 | 460 | 67 | 550 | 80 |
| | 800/40-26.5 | Front, Rear | Front, Rear | | Front, Rear | | | | 400 | 58 | 460 | 67 | 550 | 80 |
| Scorpion | 600/55-26.5/20 | Front, Rear | Front, Rear | | Front, Rear *Front, Rear | | | *Front, Rear | 450 | 65 | 450 | 65 | 550 | 80 |
| Scorpion King | 600/55R26.5 | | | | | Front, Rear | | | 450 | 65 | 450 | 65 | 550 | 80 |
| 8 wheels | 710/45-26.5/16 | | | | Front, Rear | | | | 450 | 65 | 450 | 65 | 460 | 67 |
| | 710/45-26.5/20 | Front, Rear | Front, Rear | | Front, Rear *Front, Rear | | | *Front, Rear | 450 | 65 | 450 | 65 | 550 | 80 |
| | 710/45R26.5 | | | | | Front, Rear | | | 450 | 65 | 450 | 65 | 550 | 80 |







| Machine | Tire size / PR | Tread pattern | | | | | | | Inflation pressure | | | | | |
|-----------------|----------------|---|---|---|--|---|---|---|--------------------|-----|------|-----|----------------------------------|-----|
| | |  |  |  |  |  |  |  | Front | | Rear | | Max inflation and track pressure | |
| | | F2 | TRS 2 | TRS 2+ | F *Nordman F | Rider | ELS | TRS *Nordman TRS | kPa | psi | kPa | psi | kPa | psi |
| | 800/40-26.5 | Front, Rear | Front, Rear | | Front, Rear | | | | 450 | 65 | 450 | 65 | 550 | 80 |
| Cobra | 600/55-26.5/20 | Front, Rear | Front, Rear | | Front, Rear *Front, Rear | | | *Front, Rear | 350 | 51 | 460 | 67 | 550 | 80 |
| 8 wheels | 600/55R26.5 | | | | | Front, Rear | | | 350 | 51 | 460 | 67 | 550 | 80 |
| | 710/45-26.5/16 | | | | Front, Rear | | | | 350 | 51 | 460 | 67 | 460 | 67 |
| | 710/45-26.5/20 | Front, Rear | Front, Rear | | Front, Rear *Front, Rear | | | *Front, Rear | 350 | 51 | 460 | 67 | 550 | 80 |
| | 710/45R26.5 | | | | | Front, Rear | | | 350 | 51 | 460 | 67 | 550 | 80 |
| | 800/40-26.5 | Front, Rear | Front, Rear | | Front, Rear | | | | 350 | 51 | 460 | 67 | 550 | 80 |
| Ergo | 600/55-26.5/20 | Rear | | | Rear, *Rear | | | *Rear | | | 460 | 67 | 550 | 80 |
| 6 wheels | 600/55R26.5 | | | | | Rear | | | | | 460 | 67 | 550 | 80 |
| | 710/45-26.5/16 | | | | Rear | | | | | | 460 | 67 | 460 | 67 |
| | 710/45-26.5/20 | Rear | | | Rear, *Rear | | | *Rear | | | 460 | 67 | 550 | 80 |
| | 710/45R26.5 | | | | | Rear | | | | | 460 | 67 | 550 | 80 |
| | 800/40-26.5/20 | Rear | Rear | | Rear | | | | | | 460 | 67 | 550 | 80 |
| | 600/65-34/20 | | | | | | | *Front | 300 | 44 | | | 360 | 52 |
| | 600/65-34/24 | | | Front | | | | | 300 | 44 | | | 400 | 58 |
| | 600/65R34 | | | | | Front | | | 300 | 44 | | | 400 | 58 |
| | 700/55-34/20 | | | | | | | *Front | 300 | 44 | | | 360 | 52 |
| | 710/55-34/24 | | | Front | | | | | 300 | 44 | | | 400 | 58 |
| | 710/55R34 | | | | | Front | | | 300 | 44 | | | 400 | 58 |







| Machine | Tire size / PR | Tread pattern | | | | | | | Inflation pressure | | | | | |
|-----------------|----------------|---|---|---|--|---|---|---|--------------------|-----|------|-----|----------------------------------|-----|
| | |  |  |  |  |  |  |  | Front | | Rear | | Max inflation and track pressure | |
| | | F2 | TRS 2 | TRS 2+ | F *Nordman F | Rider | ELS | TRS *Nordman TRS | kPa | psi | kPa | psi | kPa | psi |
| Ergo | 600/55-26.5/20 | Front, Rear | Front, Rear | | Front, Rear *Front, Rear | | | *Front, Rear | 350 | 51 | 460 | 67 | 550 | 80 |
| 8 wheels | 600/55R26.5 | | | | | Front, Rear | | | 350 | 51 | 460 | 67 | 550 | 80 |
| | 710/45-26.5/16 | | | | Front, Rear | | | | 350 | 51 | 460 | 67 | 460 | 67 |
| | 710/45-26.5/20 | Front, Rear | Front, Rear | | Front, Rear *Front, Rear | | | *Front, Rear | 350 | 51 | 460 | 67 | 550 | 80 |
| | 710/45R26.5 | | | | | Front, Rear | | | 350 | 51 | 460 | 67 | 550 | 80 |
| | 800/40-26.5 | Front, Rear | Front, Rear | | Front, Rear | | | | 350 | 51 | 460 | 67 | 550 | 80 |
| Bear | 650/65-26.5/20 | | | | | | Front, Rear | Front, Rear | 400 | 58 | 460 | 67 | 550 | 80 |
| 8 wheels | 750/55-26.5/20 | | | | Front, Rear *Front, Rear | | | Front, Rear *Front, Rear | 400 | 58 | 460 | 67 | 550 | 80 |
| | 750/55-26.5/24 | Front, Rear | Front, Rear | | | | | | 400 | 58 | 460 | 67 | 600 | 87 |
| | 780/55-26.5/20 | | | | Front, Rear | | | | 400 | 58 | 460 | 67 | 550 | 80 |
| | 800/50R26.5 | | | | | Front, Rear | | | 400 | 58 | 460 | 67 | 550 | 80 |
| | 710/55-28.5/24 | Front, Rear | Front, Rear | | | | | | 400 | 58 | 460 | 67 | 600 | 87 |
| | 780/50-28.5/24 | Front, Rear | Front, Rear | | | | | | 400 | 58 | 460 | 67 | 600 | 87 |
| Bear | 650/65-26.5/20 | | | | | | Rear | Rear | | | 460 | 67 | 550 | 80 |
| 8 wheels | 750/55-26.5/20 | | | | Rear, *Rear | | | Rear, *Rear | | | 460 | 67 | 550 | 80 |
| | 750/55-26.5/24 | Rear | Rear | | | | | | | | 460 | 67 | 600 | 87 |
| | 780/55-26.5/20 | | | | Rear | | | | | | 460 | 67 | 550 | 80 |
| | 710/55-28.5/24 | Rear | Rear | | | | | | | | 460 | 67 | 600 | 87 |







| Machine | Tire size / PR | Tread pattern | | | | | | | Inflation pressure | | | | | |
|---------|----------------|---|---|---|--|---|---|---|--------------------|-----|------|-----|----------------------------------|-----|
| | |  |  |  |  |  |  |  | Front | | Rear | | Max inflation and track pressure | |
| | | F2 | TRS 2 | TRS 2+ | F *Nordman F | Rider | ELS | TRS *Nordman TRS | kPa | psi | kPa | psi | kPa | psi |
| | 780/50-28.5/24 | Rear | Rear | | | | | | | | 460 | 67 | 600 | 87 |
| | 800/50R26.5 | | | | | Rear | | | | | 460 | 67 | 550 | 80 |
| | 700/70-34/16 | | | | | | | Front | 260 | 38 | | | 260 | 38 |
| | 700/70-34/20 | | | | | | | Front | 300 | 44 | | | 360 | 52 |
| | 710/70-34/24 | | | Front | | | | | 300 | 44 | | | 400 | 58 |
| | 710/70R34 | | | | | Front | | | 300 | 44 | | | 400 | 58 |







PONSSE FORWARDERS





| Machine | Tire size / PR | Tread pattern | | | | | | Inflation pressure | | | | | |
|----------------------|----------------|---|---|---|---|---|---|--------------------|-----|------|-----|----------------------------------|-----|
| | |  |  |  |  |  |  | Front | | Rear | | Max inflation and track pressure | |
| | | F2 | TRS 2 | TRS 2+ | F *Nordman F | Rider | TRS *Nordman TRS | kPa | psi | kPa | psi | kPa | psi |
| Gazelle | 600/50-22.5/20 | Front, Rear | Front, Rear | | | | Front, Rear | 350 | 51 | 500 | 73 | 550 | 80 |
| 8 wheels | 710/40-22.5/16 | | | | Front, Rear | | Front, Rear | 350 | 51 | 430 | 62 | 430 | 62 |
| | 710/40-22.5/20 | Front, Rear | Front, Rear | | | | | 350 | 51 | 430 | 62 | 550 | 80 |
| Wisent / Dual | 600/55-26.5/20 | Front, Rear | Front, Rear | | Front, Rear *Front, Rear | | *Front, Rear | 350 | 51 | 550 | 80 | 550 | 80 |
| 8 wheels | 600/55R26.5 | | | | | Front, Rear | | 350 | 51 | 550 | 80 | 550 | 80 |
| | 710/45-26.5/16 | | | | Front, Rear | | | 350 | 51 | 460 | 67 | 460 | 67 |

| Machine | Tire size / PR | Tread pattern | | | | | | Inflation pressure | | | | | |
|----------------------|----------------|---|---|---|---|---|---|--------------------|-----|------|-----|----------------------------------|-----|
| | |  |  |  |  |  |  | Front | | Rear | | Max inflation and track pressure | |
| | | F2 | TRS 2 | TRS 2+ | F *Nordman F | Rider | TRS *Nordman TRS | kPa | psi | kPa | psi | kPa | psi |
| | 710/45-26.5/20 | Front, Rear | Front, Rear | | Front, Rear *Front, Rear | | *Front, Rear | 350 | 51 | 500 | 73 | 550 | 80 |
| | 710/45R26.5 | | | | | Front, Rear | | 350 | 51 | 500 | 73 | 550 | 80 |
| | 800/40-26.5/20 | Front, Rear | Front, Rear | | Front, Rear | | | 350 | 51 | 500 | 73 | 500 | 73 |
| Wisent / Dual | 600/55-26.5/20 | Rear | Rear | | Rear, *Rear | | *Rear | | | 550 | 80 | 550 | 80 |
| 6 wheels | 600/55R26.5 | | | | | Rear | | | | 550 | 80 | 550 | 80 |
| | 710/45-26.5/16 | | | | Rear | | | | | 460 | 67 | 460 | 67 |
| | 710/45-26.5/20 | Rear | Rear | | Rear, *Rear | | *Rear | | | 500 | 73 | 550 | 80 |
| | 710/45R26.5 | | | | | Rear | | | | 500 | 73 | 550 | 80 |
| | 800/40-26.5/20 | Rear | Rear | | Rear | | | | | 500 | 73 | 550 | 80 |
| | 600/65-34/20 | | | | | | *Front | 300 | 44 | | | 360 | 52 |
| | 600/65-34/24 | | | Front | | | | 300 | 44 | | | 400 | 58 |
| | 600/65R34 | | | | | Front | | 300 | 44 | | | 400 | 58 |
| | 700/55-34/20 | | | | | | *Front | 300 | 44 | | | 360 | 52 |
| | 710/55-34/24 | | | Front | | | | 300 | 44 | | | 400 | 58 |
| | 710/55R34 | | | | | Front | | 300 | 44 | | | 400 | 58 |
| Elk | 600/55-26.5/20 | Front, Rear | Front, Rear | | Front, Rear *Front, Rear | | *Front, Rear | 350 | 51 | 550 | 80 | 550 | 80 |
| 8 wheels | 600/55R26.5 | | | | | Front, Rear | | 350 | 51 | 550 | 80 | 550 | 80 |
| | 710/45-26.5/20 | Front, Rear | Front, Rear | | Front, Rear *Front, Rear | | *Front, Rear | 350 | 51 | 500 | 73 | 550 | 80 |







| Machine | Tire size / PR | Tread pattern | | | | | | Inflation pressure | | | | | |
|-----------------|----------------|---|---|---|---|---|---|--------------------|-----|------|-----|----------------------------------|-----|
| | |  |  |  |  |  |  | Front | | Rear | | Max inflation and track pressure | |
| | | F2 | TRS 2 | TRS 2+ | F *Nordman F | Rider | TRS *Nordman TRS | kPa | psi | kPa | psi | kPa | psi |
| | 710/45-26.5/24 | Front, Rear | | | Front, Rear | | | 350 | 51 | 500 | 73 | 600 | 87 |
| | 710/45R26.5 | | | | | Front, Rear | | 350 | 51 | 500 | 73 | 550 | 80 |
| | 800/40-26.5/20 | Front, Rear | Front, Rear | | Front, Rear | | | 350 | 51 | 500 | 73 | 550 | 80 |
| Elk | 600/55-26.5/20 | Rear | Rear | | Rear, *Rear | | *Rear | | | 550 | 80 | 550 | 80 |
| 6 wheels | 600/55R26.5 | | | | | Rear | | | | 550 | 80 | 550 | 80 |
| | 710/45-26.5/20 | Rear | Rear | | Rear, *Rear | | *Rear | | | 500 | 73 | 550 | 80 |
| | 710/45-26.5/24 | Rear | | | Rear | | | | | 500 | 73 | 600 | 87 |
| | 710/45R26.5 | | | | | Rear | | | | 500 | 73 | 550 | 80 |
| | 800/40-26.5/20 | Rear | Rear | | Rear | | | | | 500 | 73 | 550 | 80 |
| | 600/65-34/20 | | | | | | *Front | 320 | 46 | | | 360 | 52 |
| | 600/65-34/24 | | | Front | | | | 320 | 46 | | | 400 | 58 |
| | 600/65R34 | | | | | Front | | 320 | 46 | | | 400 | 58 |
| | 700/55-34/20 | | | | | | *Front | 320 | 46 | | | 360 | 52 |
| | 710/55-34/24 | | | Front | | | | 320 | 46 | | | 400 | 58 |
| | 710/55R34 | | | | | Front | | 320 | 46 | | | 400 | 58 |
| Bison | 710/45-26.5/20 | Front, Rear | Front, Rear | | Front, Rear *Front, Rear | | *Front, Rear | 400 | 58 | 550 | 80 | 550 | 80 |
| 8 wheels | 710/45-26.5/24 | Front, Rear | Front, Rear | | Front, Rear | | | 400 | 58 | 550 | 80 | 600 | 87 |
| | 710/45R26.5 | | | | | Front, Rear | | 400 | 58 | 550 | 80 | 550 | 80 |
| | 800/40-26.5/20 | Front, Rear | Front, Rear | | Front, Rear | | | 400 | 58 | 550 | 80 | 550 | 80 |







| Machine | Tire size / PR | Tread pattern | | | | | | Inflation pressure | | | | | |
|-----------------------------|----------------|---|---|---|---|---|---|--------------------|-----|------|-----|----------------------------------|-----|
| | |  |  |  |  |  |  | Front | | Rear | | Max inflation and track pressure | |
| | | F2 | TRS 2 | TRS 2+ | F *Nordman F | Rider | TRS *Nordman TRS | kPa | psi | kPa | psi | kPa | psi |
| Buffalo / Dual | 710/45-26.5/20 | Front, Rear | Front, Rear | | Front, Rear *Front, Rear | | *Front, Rear | 400 | 58 | 550 | 80 | 550 | 80 |
| 8 wheels | 710/45-26.5/24 | Front, Rear | Front, Rear | | Front, Rear | | | 400 | 58 | 550 | 80 | 600 | 87 |
| | 710/45R26.5 | | | | | Front, Rear | | 400 | 58 | 550 | 80 | 550 | 80 |
| | 800/40-26.5/20 | Front, Rear | Front, Rear | | Front, Rear | | | 400 | 58 | 550 | 80 | 550 | 80 |
| Buffalo / Dual / ADS | 710/45-26.5/20 | Rear | Rear | | Rear, *Rear | | *Rear | | | 550 | 80 | 550 | 80 |
| 6 wheels | 710/45-26.5/24 | Rear | Rear | | Rear | | | | | 550 | 80 | 600 | 87 |
| | 710/45R26.5 | | | | | Rear | | | | 550 | 80 | 550 | 80 |
| | 800/40-26.5/20 | Rear | Rear | | Rear | | | | | 550 | 80 | 550 | 80 |
| | 600/65-34/20 | | | | | | *Front | 320 | 46 | | | 360 | 52 |
| | 600/65-34/24 | | | Front | | | | 320 | 46 | | | 400 | 58 |
| | 600/65R34 | | | | | Front | | 320 | 46 | | | 400 | 58 |
| | 700/55-34/20 | | | | | | *Front | 320 | 46 | | | 360 | 52 |
| | 710/55-34/24 | | | Front | | | | 320 | 46 | | | 400 | 58 |
| | 710/55R34 | | | | | Front | | 320 | 46 | | | 400 | 58 |
| Buffalo King | 600/55-26.5/20 | Front | Front | | Front, *Front | | *Front | 400 | 58 | | | 550 | 80 |
| 8 wheels | 600/55R26.5 | | | | | Front | | 400 | 58 | | | 550 | 80 |
| | 710/45-26.5/20 | Front | Front | | Front, *Front | | *Front | 400 | 58 | | | 550 | 80 |
| | 710/45-26.5/24 | Front | Front | | Front | | | 400 | 58 | | | 600 | 87 |
| | 710/45R26.5 | | | | | Front | | 400 | 58 | | | 550 | 80 |





| Machine | Tire size / PR | Tread pattern | | | | | | Inflation pressure | | | | | |
|---------------------|----------------|---|---|---|---|---|---|--------------------|-----|------|-----|----------------------------------|-----|
| | |  |  |  |  |  |  | Front | | Rear | | Max inflation and track pressure | |
| | | F2 | TRS 2 | TRS 2+ | F *Nordman F | Rider | TRS *Nordman TRS | kPa | psi | kPa | psi | kPa | psi |
| | 800/40-26.5/20 | Front | Front | | Front | | | 400 | 58 | | | 550 | 80 |
| | 750/55-26.5/20 | | | | Rear, *Rear | | | | | 550 | 80 | 550 | 80 |
| | 750/55-26.5/24 | Rear | Rear | | | | | | | 550 | 80 | 600 | 87 |
| | 780/55-26.5/20 | | | | Rear | | | | | 550 | 80 | 550 | 80 |
| | 800/50R26.5 | | | | | Rear | | | | 550 | 80 | 550 | 80 |
| Buffalo King | 750/55-26.5/20 | | | | Rear, *Rear | | | | | 500 | 73 | 550 | 80 |
| 6 wheels | 750/55-26.5/24 | Rear | Rear | | | | | | | 500 | 73 | 600 | 87 |
| | 780/55-26.5/20 | | | | Rear | | | | | 500 | 73 | 550 | 80 |
| | 800/50R26.5 | | | | | Rear | | | | 500 | 73 | 550 | 80 |
| | 700/70-34/16 | | | | | | Front | 260 | 38 | | | 260 | 38 |
| | 700/70-34/20 | | | | | | *Front | 300 | 44 | | | 360 | 52 |
| | 710/70-34/24 | | | Front | | | | 300 | 44 | | | 400 | 58 |
| | 710/70R34 | | | | | Front | | 300 | 44 | | | 400 | 58 |
| Elephant | 750/55-26.5/20 | | | | Front, Rear *Front, Rear | | Front, Rear *Front, Rear | 450 | 65 | 550 | 80 | 550 | 80 |
| 8 wheels | 750/55-26.5/24 | Front, Rear | Front, Rear | | | | | 450 | 65 | 600 | 87 | 600 | 87 |
| | 780/55-26.5/20 | | | | Front, Rear | | | 450 | 65 | 550 | 80 | 550 | 80 |
| | 780/50-28.5/24 | Front, Rear | Front, Rear | | | | | 450 | 65 | 600 | 87 | 600 | 87 |
| | 800/50R26.5 | | | | | Front, Rear | | 450 | 65 | 550 | 80 | 550 | 80 |
| Elephant | 750/55-26.5/20 | | | | Rear, *Rear | | Rear, *Rear | | | 550 | 80 | 550 | 80 |

| Machine | Tire size / PR | Tread pattern | | | | | | Inflation pressure | | | | | |
|----------------------|----------------|---|---|---|---|---|---|--------------------|-----|------|-----|----------------------------------|-----|
| | |  |  |  |  |  |  | Front | | Rear | | Max inflation and track pressure | |
| | | F2 | TRS 2 | TRS 2+ | F *Nordman F | Rider | TRS *Nordman TRS | kPa | psi | kPa | psi | kPa | psi |
| 6 wheels | 750/55-26.5/24 | Rear | Rear | | | | | | | 600 | 87 | 600 | 87 |
| | 780/55-26.5/20 | | | | Rear | | | | | 550 | 80 | 550 | 80 |
| | 800/50R26.5 | | | | | Rear | | | | 550 | 80 | 550 | 80 |
| | 780/50-28.5/24 | Rear | Rear | | | | | | | 600 | 87 | 600 | 87 |
| | 700/70-34/16 | | | | | | Front | 260 | 38 | | | 260 | 38 |
| | 700/70-34/20 | | | | | | *Front | 320 | 46 | | | 360 | 52 |
| | 710/70-34/24 | | | Front | | | | 320 | 46 | | | 400 | 58 |
| | 710/70R34 | | | | | Front | | 320 | 46 | | | 400 | 58 |
| Elephant King | 750/55-26.5/20 | | | | Front, Rear *Front, Rear | | Front, Rear *Front, Rear | 450 | 65 | 550 | 80 | 550 | 80 |
| 8 wheels | 750/55-26.5/24 | Front, Rear | Front, Rear | | | | | 450 | 65 | 600 | 87 | 600 | 87 |
| | 780/55-26.5/20 | | | | Front, Rear | | | 450 | 65 | 550 | 80 | 550 | 80 |
| | 780/50-28.5/24 | Front, Rear | Front, Rear | | | | | 450 | 65 | 600 | 87 | 600 | 87 |
| | 800/50R26.5 | | | | | Front, Rear | | 450 | 65 | 550 | 80 | 550 | 80 |







ROTTNE HARVESTERS







| Machine | Tire size / PR | Tread pattern | | | | | | Inflation pressure | | | | | | | | | | | | | | | |
|-----------------|----------------|---|---|---|--|---|---|--------------------|-----|------|-----|----------------------------------|-----|--|--|--|--|--|--|--|--|--|--|
| | |  |  |  |  |  |  | Front | | Rear | | Max inflation and track pressure | | | | | | | | | | | |
| | | F2 | TRS 2 | TRS 2+ | F *Nordman F | Rider | TRS *Nordman TRS | kPa | psi | kPa | psi | kPa | psi | | | | | | | | | | |
| H8 | 600/55-26.5/20 | Front, Rear | Front, Rear | | Front, Rear *Front, Rear | | | | | | | | | | | | | | | | | | |
| 4 wheels | 600/55R26.5 | | | | | Front, Rear | | | | | | | | | | | | | | | | | |
| | 710/45-26.5/20 | Front, Rear | Front, Rear | | Front, Rear *Front, Rear | | | | | | | | | | | | | | | | | | |
| | 710/45R26.5 | | | | | Front, Rear | | | | | | | | | | | | | | | | | |
| | 800/40-26.5/20 | Front, Rear | Front, Rear | | Front, Rear | | | | | | | | | | | | | | | | | | |
| H11 | 600/50R24.5 | | | | | Front | | | | | | | | | | | | | | | | | |
| 6 wheels | 650/45R24.5 | | | | | Front | | | | | | | | | | | | | | | | | |
| | 710/40-24.5 | Front | Front | | Front, *Front | | | | | | | | | | | | | | | | | | |
| | 800/40-24.5/20 | Front | Front | | | | | | | | | | | | | | | | | | | | |
| | 600/65-34/20 | | | | | | | | | | | | | | | | | | | | | | |
| | 600/65-34/24 | | | Rear | | | | | | | | | | | | | | | | | | | |
| | 600/65R34 | | | | | Rear | | | | | | | | | | | | | | | | | |
| | 700/55-34/20 | | | | | | | | | | | | | | | | | | | | | | |
| | 710/55-34/24 | | | Rear | | | | | | | | | | | | | | | | | | | |
| | 710/55R34 | | | | | Rear | | | | | | | | | | | | | | | | | |
| H11c | 600/50R24.5 | | | | | Front, Rear | | | | | | | | | | | | | | | | | |
| 8 wheels | 650/45R24.5 | | | | | Front, Rear | | | | | | | | | | | | | | | | | |

| Machine | Tire size / PR | Tread pattern | | | | | | Inflation pressure | | | | | | |
|-----------------|----------------|---|---|---|--|---|---|--------------------|-----|------|-----|----------------------------------|-----|----|
| | |  |  |  |  |  |  | Front | | Rear | | Max inflation and track pressure | | |
| | | F2 | TRS 2 | TRS 2+ | F *Nordman F | Rider | TRS *Nordman TRS | kPa | psi | kPa | psi | kPa | psi | |
| | 710/40-24.5 | Front, Rear | Front, Rear | | Front, Rear *Front, Rear | | | 500 | 73 | 450 | 65 | 550 | 80 | |
| H14c | 600/55-26.5/20 | Front | Front | | Front, *Front | | | *Front | 500 | 73 | | | 550 | 80 |
| 6 wheels | 600/55R26.5 | | | | | Front | | | 500 | 73 | | | 550 | 80 |
| | 710/45-26.5/20 | Front | Front | | Front, *Front | | | *Front | 500 | 73 | | | 550 | 80 |
| | 710/45R26.5 | | | | | Front | | | 500 | 73 | | | 550 | 80 |
| | 800/40-26.5/20 | Front | Front | | Front | | | | 500 | 73 | | | 550 | 80 |
| | 600/65-34/20 | | | | | | | *Rear | | | 280 | 41 | 360 | 52 |
| | 600/65-34/24 | | | Rear | | | | | | | 280 | 41 | 400 | 58 |
| | 600/65R34 | | | | | Rear | | | | | 280 | 41 | 400 | 58 |
| | 700/55-34/20 | | | | | | | *Rear | | | 280 | 41 | 360 | 52 |
| | 710/55-34/24 | | | Rear | | | | | | | 280 | 41 | 400 | 58 |
| | 710/55R34 | | | | | Rear | | | | | 280 | 41 | 400 | 58 |
| H20b | 750/55-26.5/20 | | | | Front, *Front | | | *Front | 500 | 73 | | | 550 | 80 |
| 6 wheels | 750/55-26.5/24 | Front | Front | | | | | | 500 | 73 | | | 550 | 80 |
| | 780/55-26.5/20 | | | | Front | | | | 500 | 73 | | | 550 | 80 |
| | 700/70-34/16 | | | | | | | Rear | | | 260 | 38 | 260 | 38 |
| | 700/70-34/20 | | | | | | | *Rear | | | 300 | 44 | 360 | 52 |
| | 710/70-34/24 | | | Rear | | | | | | | 300 | 44 | 400 | 58 |
| | 710/70R34 | | | | | Rear | | | | | 300 | 44 | 400 | 58 |

| Machine | Tire size / PR | Tread pattern | | | | | | Inflation pressure | | | | | | |
|-----------------|----------------|---|---|---|--|---|---|--------------------|-----|------|-----|----------------------------------|-----|----|
| | |  |  |  |  |  |  | Front | | Rear | | Max inflation and track pressure | | |
| | | F2 | TRS 2 | TRS 2+ | F *Nordman F | Rider | TRS *Nordman TRS | kPa | psi | kPa | psi | kPa | psi | |
| H21d | 750/55-26.5/20 | | | | Front, Rear *Front, Rear | | | *Front, Rear | 500 | 73 | 450 | 65 | 550 | 80 |
| 8 wheels | 750/55-26.5/24 | Front, Rear | Front, Rear | | | | | | 500 | 73 | 450 | 65 | 600 | 87 |
| | 780/55-26.5/20 | | | | Front | | | | 500 | 73 | 450 | 65 | 550 | 80 |
| H21d | 750/55-26.5/20 | | | | Front, Rear *Front, Rear | | | *Front, Rear | 500 | 73 | 450 | 65 | 550 | 80 |
| 6 wheels | 750/55-26.5/24 | Front, Rear | Front, Rear | | | | | | 500 | 73 | 450 | 65 | 600 | 87 |
| | 780/55-26.5/20 | | | | Front | | | | 500 | 73 | 450 | 65 | 550 | 80 |
| | 700/70-34/16 | | | | | | | Rear | | | 260 | 38 | 260 | 38 |
| | 700/70-34/20 | | | | | | | *Rear | | | 300 | 44 | 360 | 52 |
| | 710/70-34/24 | | | Rear | | | | | | | 300 | 44 | 400 | 58 |
| | 710/70R34 | | | | | Rear | | | | | 300 | 44 | 400 | 58 |





ROTTNE FORWARDERS





| Machine | Tire size / PR | Tread pattern | | | | | | Inflation pressure | | | | | | |
|-----------------|----------------|---|---|---|--|---|---|--------------------|-----|------|-----|----------------------------------|-----|----|
| | |  |  |  |  |  |  | Front | | Rear | | Max inflation and track pressure | | |
| | | F2 | TRS 2 | TRS 2+ | F *Nordman F | Rider | TRS *Nordman TRS | kPa | psi | kPa | psi | kPa | psi | |
| F10b | 600/50-22.5/20 | Front, Rear | Front, Rear | | | | | Front, Rear | 350 | 51 | 500 | 73 | 550 | 80 |
| 8 wheels | 710/40-22.5/16 | | | | Front, Rear | | | | 350 | 51 | 400 | 58 | 550 | 80 |

| Machine | Tire size / PR | Tread pattern | | | | | | Inflation pressure | | | | | |
|-----------------|----------------|---|---|---|--|---|---|--------------------|-----|------|-----|----------------------------------|-----|
| | |  |  |  |  |  |  | Front | | Rear | | Max inflation and track pressure | |
| | | F2 | TRS 2 | TRS 2+ | F *Nordman F | Rider | TRS *Nordman TRS | kPa | psi | kPa | psi | kPa | psi |
| | 710/40-22.5/20 | Front, Rear | Front, Rear | | | | | 350 | 51 | 500 | 73 | 550 | 80 |
| F10d | 600/50-22.5/20 | Front, Rear | Front, Rear | | | | Front, Rear | 350 | 51 | 550 | 80 | 550 | 80 |
| 8 wheels | 710/40-22.5/20 | Front, Rear | Front, Rear | | | | | 350 | 51 | 550 | 80 | 550 | 80 |
| F11d | 600/50-24.5/20 | | Front, Rear | | | | | 350 | 51 | 550 | 80 | 550 | 80 |
| 8 wheels | 710/40-24.5/20 | Front, Rear | Front, Rear | | Front, Rear *Front, Rear | | | 350 | 51 | 550 | 80 | 550 | 80 |
| | 800/40-24.5/20 | Front, Rear | Front, Rear | | | | | 350 | 51 | 550 | 80 | 550 | 80 |
| F13c | 600/55-26.5/20 | Front, Rear | Front, Rear | | Front, Rear *Front, Rear | | *Front, Rear | 350 | 51 | 550 | 80 | 550 | 80 |
| 8 wheels | 600/55R26.5 | | | | | Front, Rear | | 350 | 51 | 550 | 80 | 550 | 80 |
| | 710/45-26.5/20 | Front, Rear | Front, Rear | | Front, Rear *Front, Rear | | *Front, Rear | 350 | 51 | 500 | 73 | 550 | 80 |
| | 710/45R26.5 | | | | | Front, Rear | | 350 | 51 | 500 | 73 | 550 | 80 |
| | 800/40-26.5/20 | Front, Rear | Front, Rear | | Front, Rear | | | 350 | 51 | 500 | 73 | 550 | 80 |
| F15c | 600/55-26.5/20 | Front, Rear | Front, Rear | | Front, Rear *Front, Rear | | *Front, Rear | 450 | 65 | 550 | 80 | 550 | 80 |
| 8 wheels | 600/55R26.5 | | | | | Front, Rear | | 450 | 65 | 550 | 80 | 550 | 80 |
| | 710/45-26.5/20 | Front, Rear | Front, Rear | | Front, Rear *Front, Rear | | *Front, Rear | 400 | 58 | 550 | 80 | 550 | 80 |
| | 710/45R26.5 | | | | | Front, Rear | | 400 | 58 | 550 | 80 | 550 | 80 |
| | 800/40-26.5/20 | Front, Rear | Front, Rear | | Front, Rear | | | 400 | 58 | 550 | 80 | 550 | 80 |
| F18 | 750/55-26.5/20 | | | | Rear, *Rear | | Rear, *Rear | | | 550 | 80 | 550 | 80 |





| Machine | Tire size / PR | Tread pattern | | | | | | Inflation pressure | | | | | |
|-----------------|----------------|---|---|---|--|---|---|--------------------|-----|------|-----|----------------------------------|-----|
| | |  |  |  |  |  |  | Front | | Rear | | Max inflation and track pressure | |
| | | F2 | TRS 2 | TRS 2+ | F *Nordman F | Rider | TRS *Nordman TRS | kPa | psi | kPa | psi | kPa | psi |
| 6 wheels | 750/55-26.5/24 | Rear | Rear | | | | | | | 600 | 87 | 600 | 87 |
| | 780/55-26.5/20 | | | | Rear | | | | | 550 | 80 | 550 | 80 |
| | 700/70-34/16 | | | | | | Front | 260 | 38 | | | 260 | 38 |
| | 700/70-34/20 | | | | | | *Front | 320 | 46 | | | 360 | 52 |
| | 710/70-34/24 | | | Front | | | | 320 | 46 | | | 400 | 58 |
| | 710/70R34 | | | | | Front | | 320 | 46 | | | 400 | 58 |
| F18 | 750/55-26.5/20 | | | | Front, Rear *Front, Rear | | Front, Rear *Front, Rear | 450 | 65 | 550 | 80 | 550 | 80 |
| 8 wheels | 750/55-26.5/24 | Front, Rear | Front, Rear | | | | | 450 | 65 | 600 | 87 | 600 | 87 |
| | 780/55-26.5/20 | | | | Front, Rear | | | 450 | 65 | 550 | 80 | 550 | 80 |
| F20 | 750/55-26.5/24 | Front, Rear | Front, Rear | | | | | 450 | 65 | 600 | 87 | 600 | 87 |
| 8 wheels | 780/50-28.5/24 | Front, Rear | Front, Rear | | | | | 450 | 65 | 600 | 87 | 600 | 87 |





TIGERCAT HARVESTERS

| Machine | Tire size / PR | Tread pattern | | | | | Inflation pressure | | | | | |
|-----------------|----------------|---|---|---|--|---|--------------------|-----|------|-----|----------------------------------|-----|
| | |  |  |  |  |  | Front | | Rear | | Max inflation and track pressure | |
| | | F2 | TRS 2 | TRS 2+ | F *Nordman F | TRS *Nordman TRS | kPa | psi | kPa | psi | kPa | psi |
| 1165 | 600/55-26.5/20 | Front | Front | | Front | Front | 550 | 80 | 400 | 58 | 550 | 80 |
| 6 wheels | 710/45-26.5/20 | Front | Front | | Front | Front | 550 | 80 | 400 | 58 | 550 | 80 |



| Machine | Tire size / PR | Tread pattern | | | | | Inflation pressure | | | | | |
|-----------------|----------------|---|---|---|---|---|--------------------|-----|------|-----|----------------------------------|-----|
| | |  |  |  |  |  | Front | | Rear | | Max inflation and track pressure | |
| | | F2 | TRS 2 | TRS 2+ | F *Nordman F | TRS *Nordman TRS | kPa | psi | kPa | psi | kPa | psi |
| | 710/45-26.5/24 | Front | Front | | | | 600 | 87 | 400 | 58 | 600 | 87 |
| | 600/65-34/24 | | | Rear | | | | | 400 | 58 | 400 | 58 |
| | 710/55-34/24 | | | Rear | | | | | 400 | 58 | 400 | 58 |
| 1165 | 710/45-26.5/20 | Front, Rear | Front, Rear | | Front, Rear | Front, Rear | 550 | 80 | 400 | 58 | 550 | 80 |
| 8 wheels | 710/45-26.5/24 | Front, Rear | Front, Rear | | Front, Rear | Front, Rear | 600 | 87 | 400 | 58 | 600 | 87 |
| 1185 | 750/55-26.5/20 | | | | Front, Rear | Front, Rear | 550 | 80 | 450 | 65 | 550 | 80 |
| 8 wheels | 750/55-26.5/24 | Front, Rear | Front, Rear | | | | 600 | 87 | 450 | 65 | 600 | 87 |
| | 710/55-28.5/24 | Front, Rear | Front, Rear | | | | 600 | 87 | 450 | 65 | 600 | 87 |
| | 780/50-28.5/24 | Front, Rear | Front, Rear | | | | 600 | 87 | 450 | 65 | 600 | 87 |



TIGERCAT FORWARDERS

| Machine | Tire size / PR | Tread pattern | | | | Inflation pressure | | | | | |
|-----------------|----------------|---|---|--|---|--------------------|-----|------|-----|----------------------------------|-----|
| | |  |  |  |  | Front | | Rear | | Max inflation and track pressure | |
| | | F2 | TRS 2 | F *Nordman F | TRS *Nordman TRS | kPa | psi | kPa | psi | kPa | psi |
| 1055C | 600/50-26.5/20 | Front, Rear | Front, Rear | Front, Rear | Front, Rear | 550 | 80 | 550 | 80 | 550 | 80 |
| 8 wheels | 710/45-26.5/20 | Front, Rear | Front, Rear | Front, Rear | Front, Rear | 550 | 80 | 550 | 80 | 550 | 80 |
| | 710/45-26.5/24 | Front, Rear | | | | 600 | 87 | 600 | 87 | 600 | 87 |
| | 800/40-26.5/20 | Front, Rear | Front, Rear | Front, Rear | | 550 | 80 | 550 | 80 | 550 | 80 |



| Machine | Tire size / PR | Tread pattern | | | | Inflation pressure | | | | | |
|-----------------|----------------|---|---|--|---|--------------------|-----|------|-----|----------------------------------|-----|
| | |  |  |  |  | Front | | Rear | | Max inflation and track pressure | |
| | | F2 | TRS 2 | F *Nordman F | TRS *Nordman TRS | kPa | psi | kPa | psi | kPa | psi |
| 1075C | 750/55-26.5/20 | | | Front, Rear | Front, Rear | 600 | 87 | 600 | 87 | 600 | 87 |
| 8 wheels | 750/55-26.5/24 | Front, Rear | Front, Rear | | | 600 | 87 | 600 | 87 | 600 | 87 |
| | 780/50-28.5/24 | Front, Rear | Front, Rear | | | 600 | 87 | 600 | 87 | 600 | 87 |
| 1085C | 750/55-26.5/24 | Front, Rear | Front, Rear | | | 600 | 87 | 600 | 87 | 600 | 87 |
| 8 wheels | 780/50-28.5/24 | Front, Rear | Front, Rear | | | 600 | 87 | 600 | 87 | 600 | 87 |



ECOLOG HARVESTERS

| Machine | Tire size / PR | Tread pattern | | | Inflation pressure | | | | | |
|------------------|----------------|---|--|---|--------------------|-----|------|-----|----------------------------------|-----|
| | |  F2 |  TRS 2 |  TRS 2+ | Front | | Rear | | Max inflation and track pressure | |
| | | | | | kPa | psi | kPa | psi | kPa | psi |
| 1058H5 | 600/55-22.5/20 | Front, Rear | Front, Rear | | 400 | 58 | 350 | 51 | 550 | 80 |
| 8 wheels | 710/45-22.5/20 | Front, Rear | Front, Rear | | 400 | 58 | 350 | 51 | 550 | 80 |
| 550F | 600/65-34/24 | | | Front, Rear | 300 | 44 | 300 | 44 | 400 | 58 |
| 4 wheels | 710/55-34/24 | | | Front, Rear | 300 | 44 | 300 | 44 | 400 | 58 |
| 550 T-PRO | 600/55-26.5/20 | Front | Front | | 400 | 58 | | | 550 | 80 |
| 6 wheels | 710/45-26.5/20 | Front | Front | | 400 | 58 | | | 550 | 80 |
| | 600/65-34/20 | | | Rear | | | 350 | 51 | 400 | 58 |
| | 710/55-34/20 | | | Rear | | | 350 | 51 | 400 | 58 |
| 560F | 600/55-26.5/20 | Front | Front | | 450 | 65 | | | 550 | 80 |
| 6 wheels | 710/45-26.5/20 | Front | Front | | 450 | 65 | | | 550 | 80 |
| | 600/65-34/20 | | | Rear | | | 350 | 51 | 400 | 58 |
| | 710/55-34/20 | | | Rear | | | 350 | 51 | 400 | 58 |
| 580F | 600/55-26.5/20 | Front | Front | | 500 | 73 | | | 550 | 80 |
| 6 wheels | 710/45-26.5/20 | Front | Front | | 500 | 73 | | | 550 | 80 |
| | 600/65-34/24 | | | Rear | | | 350 | | 400 | 58 |
| | 710/55-34/24 | | | Rear | | | 350 | | 400 | 58 |
| 590F | 710/55-26.5/24 | Front | Front | | | | | | 600 | 87 |
| 6 wheels | 710/55-28.5/24 | Front | Front | | | | | | 600 | 87 |
| | 710/55-34/24 | | | Rear | | | | | 400 | 58 |

| Machine | Tire size / PR | Tread pattern | | | Inflation pressure | | | | | |
|-----------------|----------------|---|---|---|--------------------|-----|------|-----|----------------------------------|-----|
| | |  |  |  | Front | | Rear | | Max inflation and track pressure | |
| | | F2 | TRS 2 | TRS 2+ | kPa | psi | kPa | psi | kPa | psi |
| | 710/70-34/24 | | | Rear | | | | | 400 | 58 |
| 688F | 600/55-26.5/20 | Front, Rear | Front, Rear | | | | | | 550 | 80 |
| 8 wheels | 710/45-26.5/20 | Front, Rear | Front, Rear | | | | | | 550 | 80 |
| | 800/40-26.5/20 | Front, Rear | Front, Rear | | | | | | 550 | 80 |

ECOLOG FORWARDERS

| Machine | Tire size / PR | Tread pattern | | Inflation pressure | | | | | |
|-----------------|----------------|---|--|--------------------|-----|------|-----|----------------------------------|-----|
| | |  |  | Front | | Rear | | Max inflation and track pressure | |
| | | F2 | TRS 2 | kPa | psi | kPa | psi | kPa | psi |
| 750F | 600/55-22.5/20 | Front, Rear | Front, Rear | 350 | 51 | 500 | 73 | 550 | 80 |
| 8 wheels | 710/45-22.5/20 | Front, Rear | Front, Rear | 350 | 51 | 500 | 73 | 550 | 80 |
| 1050F | 600/55-22.5/20 | Front, Rear | Front, Rear | 350 | 51 | 500 | 73 | 550 | 80 |
| 8 wheels | 710/45-22.5/20 | Front, Rear | Front, Rear | 350 | 51 | 500 | 73 | 550 | 80 |
| 1250F | 600/55-26.5/20 | Front, Rear | Front, Rear | 400 | 58 | 550 | 80 | 550 | 80 |
| 8 wheels | 710/45-26.5/20 | Front, Rear | Front, Rear | 400 | 58 | 500 | 73 | 550 | 80 |
| | 710/45-26.5/24 | Front, Rear | Front, Rear | 400 | 58 | 500 | 73 | 600 | 87 |
| | 800/40-26.5/20 | Front, Rear | Front, Rear | 400 | 58 | 500 | 73 | 550 | 80 |
| 574F | 600/55-26.5/20 | Front, Rear | Front, Rear | 400 | 58 | 550 | 80 | 550 | 80 |
| 8 wheels | 710/45-26.5/20 | Front, Rear | Front, Rear | 400 | 58 | 550 | 80 | 550 | 80 |

| Machine | Tire size / PR | Tread pattern | | Inflation pressure | | | | | |
|-----------------|----------------|---|---|--------------------|-----|------|-----|----------------------------------|-----|
| | |  F2 |  TRS 2 | Front | | Rear | | Max inflation and track pressure | |
| | | | | kPa | psi | kPa | psi | kPa | psi |
| | 710/45-26.5/24 | Front, Rear | Front, Rear | 400 | 58 | 550 | 80 | 600 | 87 |
| | 800/40-26.5/20 | Front, Rear | Front, Rear | 400 | 58 | 550 | 80 | 550 | 80 |
| 584F | 710/45-26.5/20 | Front, Rear | Front, Rear | 400 | 58 | 550 | 80 | 550 | 80 |
| 8 wheels | 710/45-26.5/24 | Front, Rear | Front, Rear | 400 | 58 | 600 | 87 | 600 | 87 |
| | 800/40-26.5/20 | Front, Rear | Front, Rear | 400 | 58 | 550 | 80 | 550 | 80 |
| 594F | 750/55-26.5/24 | Front, Rear | Front, Rear | 450 | 65 | 600 | 87 | 600 | 87 |
| 8 wheels | 710/55-28.5/24 | Front, Rear | Front, Rear | 450 | 65 | 600 | 87 | 600 | 87 |
| | 780/55-28.5/24 | Front, Rear | Front, Rear | 450 | 65 | 600 | 87 | 600 | 87 |

GROUND CONTACT PRESSURE COMPARISON

GROUND PRESSURE COMPARISON BETWEEN DIFFERENT TIRE SIZES

Both the tire diameter and width have an important role in determining the size of tire contact area. In practice the tire diameter increase has greater effect on machine mobility than the width increase. Due to the variation in operating ground the absolute ground pressure values can be difficult to assess. However the information in this table is useful when comparing the relative performance of different tires.

CONTACT AREA AND GROUND PRESSURE AT DIFFERENT TYRE LOADS. SOFT SOIL.

| Size | 600/50-22.5 | | 710/40-22.5 | | 710/40-24.5 | | 500/60-26.5 | | 600/55-26.5 | | 650/60-26.5 | | 650/65-26.5 | | 710/45-26.5 | | |
|-----------------|------------------------|--------------------------|--------------------------|--------------------------|--------------------------|--------------------------|--------------------------|--------------------------|--------------------------|--------------------------|--------------------------|--------------------------|--------------------------|--------------------------|--------------------------|--------------------------|--------------------------|
| | mm | in | mm | in | mm | in | mm | in | mm | in | mm | in | mm | in | mm | in | |
| Diameter | 1171 | 46,1 | 1171 | 46,1 | 1230 | 48,4 | 1273 | 50,1 | 1340 | 52,8 | 1485 | 58,5 | 1485 | 58,5 | 1340 | 52,8 | |
| Width | 601 | 23,7 | 710 | 28,0 | 710 | 28,0 | 503 | 19,8 | 601 | 23,7 | 650 | 25,6 | 650 | 25,6 | 710 | 28,0 | |
| | cm ² | in ² | cm ² | in ² | cm ² | in ² | cm ² | in ² | cm ² | in ² | cm ² | in ² | cm ² | in ² | cm ² | in ² | |
| Contact area *) | 3520 | 545,56 | 4160 | 644,76 | 4370 | 677,31 | 3200 | 495,97 | 4030 | 624,61 | 4830 | 748,6 | 4830 | 748,6 | 4760 | 737,75 | |
| Load | Ground pressure | | Ground pressure | | Ground pressure | | Ground pressure | | Ground pressure | | Ground pressure | | Ground pressure | | Ground pressure | | |
| kg | lb | kg/cm² | lb/in² | kg/cm² | lb/in² | kg/cm² | lb/in² | kg/cm² | lb/in² | kg/cm² | lb/in² | kg/cm² | lb/in² | kg/cm² | lb/in² | kg/cm² | lb/in² |
| 500 | 1100 | 0,14 | 2,02 | 0,12 | 1,71 | 0,11 | 1,62 | 0,16 | 2,22 | 0,12 | 1,76 | 0,10 | 1,47 | 0,10 | 1,47 | 0,11 | 1,49 |
| 1000 | 2205 | 0,28 | 4,04 | 0,24 | 3,42 | 0,23 | 3,26 | 0,31 | 4,45 | 0,25 | 3,53 | 0,21 | 2,95 | 0,21 | 2,95 | 0,21 | 2,99 |
| 1500 | 3305 | 0,43 | 6,06 | 0,36 | 5,13 | 0,34 | 4,88 | 0,47 | 6,66 | 0,37 | 5,29 | 0,31 | 4,41 | 0,31 | 4,41 | 0,32 | 4,48 |

| | | | | | | | | | | | | | | | | | |
|-------|-------|------|-------|------|-------|------|-------|------|-------|------|-------|------|-------|------|-------|------|-------|
| 2000 | 4410 | 0,57 | 8,08 | 0,48 | 6,84 | 0,46 | 6,51 | 0,63 | 8,89 | 0,50 | 7,06 | 0,41 | 5,89 | 0,41 | 5,89 | 0,42 | 5,98 |
| 2500 | 5510 | 0,71 | 10,10 | 0,60 | 8,55 | 0,57 | 8,14 | 0,78 | 11,11 | 0,62 | 8,82 | 0,52 | 7,36 | 0,52 | 7,36 | 0,53 | 7,47 |
| 3000 | 6615 | 0,85 | 12,13 | 0,72 | 10,26 | 0,69 | 9,77 | 0,94 | 13,34 | 0,74 | 10,59 | 0,62 | 8,84 | 0,62 | 8,84 | 0,63 | 8,97 |
| 3500 | 7715 | 0,99 | 14,14 | 0,84 | 11,97 | 0,80 | 11,39 | 1,09 | 15,56 | 0,87 | 12,35 | 0,72 | 10,31 | 0,72 | 10,31 | 0,74 | 10,46 |
| 4000 | 8820 | 1,14 | 16,17 | 0,96 | 13,68 | 0,92 | 13,02 | 1,25 | 17,78 | 0,99 | 14,12 | 0,83 | 11,78 | 0,83 | 11,78 | 0,84 | 11,96 |
| 4500 | 9920 | 1,28 | 18,18 | 1,08 | 15,39 | 1,03 | 14,65 | | | 1,12 | 15,88 | 0,93 | 13,25 | 0,93 | 13,25 | 0,95 | 13,45 |
| 5000 | 11025 | 1,42 | 20,21 | | | 1,14 | 16,28 | | | 1,24 | 17,65 | 1,04 | 14,73 | 1,04 | 14,73 | 1,05 | 14,94 |
| 5500 | 12125 | 1,56 | 22,22 | | | 1,26 | 17,90 | | | 1,36 | 19,41 | 1,14 | 16,20 | 1,14 | 16,20 | 1,16 | 16,44 |
| 6000 | 13230 | | | | | 1,37 | 19,53 | | | 1,49 | 21,18 | 1,24 | 17,67 | 1,24 | 17,67 | 1,26 | 17,93 |
| 6500 | 14330 | | | | | | | | | 1,61 | 22,94 | 1,35 | 19,14 | 1,35 | 19,14 | 1,37 | 19,42 |
| 7000 | 15430 | | | | | | | | | | | 1,45 | 20,61 | 1,45 | 20,61 | 1,47 | 20,91 |
| 7500 | 16535 | | | | | | | | | | | 1,55 | 22,09 | 1,55 | 22,09 | 1,58 | 22,41 |
| 8000 | 17635 | | | | | | | | | | | 1,66 | 23,56 | 1,66 | 23,56 | | |
| 8500 | 18740 | | | | | | | | | | | | | 1,76 | 25,03 | | |
| 9000 | 19840 | | | | | | | | | | | | | | | | |
| 9500 | 20945 | | | | | | | | | | | | | | | | |
| 10000 | 22045 | | | | | | | | | | | | | | | | |

*) CONTACT AREA CALCULATED BY USING A FORMULA BY THE SWEDISH FORESTRY RESEARCH INSTITUTE (SKOGSARBETEN).

CONTACT AREA AND GROUND PRESSURE AT DIFFERENT TYRE LOADS. SOFT SOIL.

| | 750/55-26.5 | | 780/55-26.5 | | 800/50R26.5 | | 710/55-28.5 | | 780/50-28.5 | | 800/40-26.5 | | 600/65-34 | | 700/55-34 | | 700/70-34 | |
|-----------------|-------------|------|-------------|------|-------------|------|-------------|------|-------------|------|-------------|------|-----------|------|-----------|------|-----------|------|
| | mm | in | mm | in | mm | in | mm | in | mm | in | mm | in | mm | in | mm | in | mm | in |
| Diameter | 1485 | 58,5 | 1485 | 58,5 | 1485 | 58,5 | 1525 | 60,0 | 1525 | 60,0 | 1340 | 52,8 | 1644 | 64,7 | 1485 | 58,5 | 1844 | 72,6 |

| Width | | 750 | 29,5 | 780 | 30,7 | 800 | 31,5 | 710 | 28,0 | 780 | 30,7 | 800 | 31,5 | 600 | 23,6 | 700 | 27,6 | 700 | 27,6 |
|----------------------------|-------|--------------------|--------------------|--------------------|--------------------|--------------------|--------------------|--------------------|--------------------|--------------------|--------------------|--------------------|--------------------|--------------------|--------------------|--------------------|--------------------|--------------------|--------------------|
| | | cm ² | in ² | cm ² | in ² | cm ² | in ² | cm ² | in ² | cm ² | in ² | cm ² | in ² | cm ² | in ² | cm ² | in ² | cm ² | in ² |
| Contact area ¹⁾ | | 5570 | 863,29 | 5790 | 897,39 | 5940 | 920,64 | 5410 | 838,5 | 5950 | 922,191 | 5360 | 830,75 | 4930 | 764,101 | 5200 | 805,948 | 6450 | 999,686 |
| Load | | Ground pressure | | Ground pressure | | Ground pressure | | Ground pressure | | Ground pressure | | Ground pressure | | Ground pressure | | Ground pressure | | Ground pressure | |
| kg | lb | kg/cm ² | lb/in ² | kg/cm ² | lb/in ² | kg/cm ² | lb/in ² | kg/cm ² | lb/in ² | kg/cm ² | lb/in ² | kg/cm ² | lb/in ² | kg/cm ² | lb/in ² | kg/cm ² | lb/in ² | kg/cm ² | lb/in ² |
| 500 | 1100 | 0,09 | 1,27 | 0,09 | 1,23 | 0,08 | 1,19 | 0,09 | 1,31 | 0,08 | 1,19 | 0,09 | 1,32 | 0,10 | 1,44 | 0,10 | 1,36 | 0,08 | 1,10 |
| 1000 | 2205 | 0,18 | 2,55 | 0,17 | 2,46 | 0,17 | 2,40 | 0,18 | 2,63 | 0,17 | 2,39 | 0,19 | 2,65 | 0,20 | 2,89 | 0,19 | 2,74 | 0,16 | 2,21 |
| 1500 | 3305 | 0,27 | 3,83 | 0,26 | 3,68 | 0,25 | 3,59 | 0,28 | 3,94 | 0,25 | 3,58 | 0,28 | 3,98 | 0,30 | 4,33 | 0,29 | 4,10 | 0,23 | 3,31 |
| 2000 | 4410 | 0,36 | 5,11 | 0,35 | 4,91 | 0,34 | 4,79 | 0,37 | 5,26 | 0,34 | 4,78 | 0,37 | 5,31 | 0,41 | 5,77 | 0,38 | 5,47 | 0,31 | 4,41 |
| 2500 | 5510 | 0,45 | 6,38 | 0,43 | 6,14 | 0,42 | 5,98 | 0,46 | 6,57 | 0,42 | 5,97 | 0,47 | 6,63 | 0,51 | 7,21 | 0,48 | 6,84 | 0,39 | 5,51 |
| 3000 | 6615 | 0,54 | 7,66 | 0,52 | 7,37 | 0,51 | 7,19 | 0,55 | 7,89 | 0,50 | 7,17 | 0,56 | 7,96 | 0,61 | 8,66 | 0,58 | 8,21 | 0,47 | 6,62 |
| 3500 | 7715 | 0,63 | 8,94 | 0,60 | 8,60 | 0,59 | 8,38 | 0,65 | 9,20 | 0,59 | 8,37 | 0,65 | 9,29 | 0,71 | 10,10 | 0,67 | 9,57 | 0,54 | 7,72 |
| 4000 | 8820 | 0,72 | 10,22 | 0,69 | 9,83 | 0,67 | 9,58 | 0,74 | 10,52 | 0,67 | 9,56 | 0,75 | 10,62 | 0,81 | 11,54 | 0,77 | 10,94 | 0,62 | 8,82 |
| 4500 | 9920 | 0,81 | 11,49 | 0,78 | 11,05 | 0,76 | 10,78 | 0,83 | 11,83 | 0,76 | 10,76 | 0,84 | 11,94 | 0,91 | 12,98 | 0,87 | 12,31 | 0,70 | 9,92 |
| 5000 | 11025 | 0,90 | 12,77 | 0,86 | 12,29 | 0,84 | 11,98 | 0,92 | 13,15 | 0,84 | 11,96 | 0,93 | 13,27 | 1,01 | 14,43 | 0,96 | 13,68 | 0,78 | 11,03 |
| 5500 | 12125 | 0,99 | 14,05 | 0,95 | 13,51 | 0,93 | 13,17 | 1,02 | 14,46 | 0,92 | 13,15 | 1,03 | 14,60 | | | 1,06 | 15,04 | 0,85 | 12,13 |
| 6000 | 13230 | 1,08 | 15,33 | 1,04 | 14,74 | 1,01 | 14,37 | 1,11 | 15,78 | 1,01 | 14,35 | 1,12 | 15,93 | | | 1,15 | 16,42 | 0,93 | 13,23 |
| 6500 | 14330 | 1,17 | 16,60 | 1,12 | 15,97 | 1,09 | 15,57 | 1,20 | 17,09 | 1,09 | 15,54 | 1,21 | 17,25 | | | | | 1,01 | 14,33 |
| 7000 | 15430 | 1,26 | 17,87 | 1,21 | 17,19 | 1,18 | 16,76 | 1,29 | 18,40 | 1,18 | 16,73 | | | | | | | 1,09 | 15,43 |
| 7500 | 16535 | 1,35 | 19,15 | 1,30 | 18,43 | 1,26 | 17,96 | 1,39 | 19,72 | 1,26 | 17,93 | | | | | | | | |
| 8000 | 17635 | 1,44 | 20,43 | 1,38 | 19,65 | 1,35 | 19,16 | 1,48 | 21,03 | 1,34 | 19,12 | | | | | | | | |
| 8500 | 18740 | 1,53 | 21,71 | 1,47 | 20,88 | 1,43 | 20,36 | 1,57 | 22,35 | 1,43 | 20,32 | | | | | | | | |
| 9000 | 19840 | 1,62 | 22,98 | 1,55 | 22,11 | 1,52 | 21,55 | 1,66 | 23,66 | 1,51 | 21,51 | | | | | | | | |

| | | | | | | | | | | | | | | | | | | |
|-------|-------|------|-------|------|-------|------|-------|------|-------|------|-------|--|--|--|--|--|--|--|
| 9500 | 20945 | 1,71 | 24,26 | 1,64 | 23,34 | 1,60 | 22,75 | 1,76 | 24,98 | 1,60 | 22,71 | | | | | | | |
| 10000 | 22045 | 1,80 | 25,54 | 1,73 | 24,57 | 1,68 | 23,95 | 1,85 | 26,29 | 1,68 | 23,91 | | | | | | | |

*) CONTACT AREA CALCULATED BY USING A FORMULA BY THE SWEDISH FORESTRY RESEARCH INSTITUTE (SKOGSARBETEN).

CONTACT AREA AND GROUND PRESSURE AT DIFFERENT TYRE LOADS. SOFT SOIL.

| | | 23.1-26 | | 28L-26 | | 30.5L-32 | | 620/75-26 | | 500/70-28 | | 540/70-30 | | 600/70-38 | | 650/75-38 | |
|-----------------|------|--------------------|--------------------|--------------------|--------------------|--------------------|--------------------|--------------------|--------------------|--------------------|--------------------|--------------------|--------------------|--------------------|--------------------|--------------------|--------------------|
| | | mm | in | mm | in | mm | in | mm | in | mm | in | mm | in | mm | in | mm | in |
| Diameter | | 1632 | 64,3 | 1644 | 64,7 | 1857 | 73,1 | 1590 | 62,6 | 1405 | 55,3 | 1515 | 59,6 | 1820 | 71,7 | 1965 | 77,4 |
| Width | | 587 | 23,1 | 714 | 28,1 | 775 | 30,5 | 625 | 24,6 | 503 | 19,8 | 540 | 21,3 | 611 | 24,1 | 650 | 25,6 |
| | | cm ² | in ² | cm ² | in ² | cm ² | in ² | cm ² | in ² | cm ² | in ² | cm ² | in ² | cm ² | in ² | cm ² | in ² |
| Contact area *) | | 4790 | 742,4 | 5870 | 909,79 | 7200 | 1115,9 | 4970 | 770,3 | 3530 | 547,11 | 4090 | 633,91 | 5560 | 861,74 | 6390 | 990,39 |
| Load | | Ground pressure | | Ground pressure | | Ground pressure | | Ground pressure | | Ground pressure | | Ground pressure | | Ground pressure | | Ground pressure | |
| kg | lb | kg/cm ² | lb/in ² | kg/cm ² | lb/in ² | kg/cm ² | lb/in ² | kg/cm ² | lb/in ² | kg/cm ² | lb/in ² | kg/cm ² | lb/in ² | kg/cm ² | lb/in ² | kg/cm ² | lb/in ² |
| 500 | 1100 | 0,10 | 1,48 | 0,09 | 1,21 | 0,07 | 0,99 | 0,10 | 1,43 | 0,14 | 2,01 | 0,12 | 1,74 | 0,09 | 1,28 | 0,08 | 1,11 |
| 1000 | 2205 | 0,21 | 2,97 | 0,17 | 2,42 | 0,14 | 1,98 | 0,20 | 2,86 | 0,28 | 4,03 | 0,24 | 3,48 | 0,18 | 2,56 | 0,16 | 2,23 |
| 1500 | 3305 | 0,31 | 4,45 | 0,26 | 3,63 | 0,21 | 2,96 | 0,30 | 4,29 | 0,42 | 6,04 | 0,37 | 5,21 | 0,27 | 3,84 | 0,23 | 3,34 |
| 2000 | 4410 | 0,42 | 5,94 | 0,34 | 4,85 | 0,28 | 3,95 | 0,40 | 5,73 | 0,57 | 8,06 | 0,49 | 6,96 | 0,36 | 5,12 | 0,31 | 4,45 |
| 2500 | 5510 | 0,52 | 7,42 | 0,43 | 6,06 | 0,35 | 4,94 | 0,50 | 7,15 | 0,71 | 10,07 | 0,61 | 8,69 | 0,45 | 6,39 | 0,39 | 5,56 |
| 3000 | 6615 | 0,63 | 8,91 | 0,51 | 7,27 | 0,42 | 5,93 | 0,60 | 8,59 | 0,85 | 12,09 | 0,73 | 10,44 | 0,54 | 7,68 | 0,47 | 6,68 |
| 3500 | 7715 | 0,73 | 10,39 | 0,60 | 8,48 | 0,49 | 6,91 | 0,70 | 10,02 | 0,99 | 14,10 | 0,86 | 12,17 | 0,63 | 8,95 | 0,55 | 7,79 |
| 4000 | 8820 | 0,84 | 11,88 | 0,68 | 9,69 | 0,56 | 7,90 | 0,80 | 11,45 | 1,13 | 16,12 | 0,98 | 13,91 | 0,72 | 10,24 | 0,63 | 8,91 |
| 4500 | 9920 | 0,94 | 13,36 | 0,77 | 10,90 | 0,63 | 8,89 | 0,91 | 12,88 | | | 1,10 | 15,65 | 0,81 | 11,51 | 0,70 | 10,02 |

| | | | | | | | | | | | | | | | | | |
|------|-------|------|-------|------|-------|------|-------|------|-------|--|--|--|--|------|-------|------|-------|
| 5000 | 11025 | 1,04 | 14,85 | 0,85 | 12,12 | 0,69 | 9,88 | 1,01 | 14,31 | | | | | 0,90 | 12,79 | 0,78 | 11,13 |
| 5500 | 12125 | 1,15 | 16,33 | 0,94 | 13,33 | 0,76 | 10,87 | 1,11 | 15,74 | | | | | 0,99 | 14,07 | 0,86 | 12,24 |
| 6000 | 13230 | 1,25 | 17,82 | 1,02 | 14,54 | 0,83 | 11,86 | | | | | | | 1,08 | 15,35 | 0,94 | 13,36 |
| 6500 | 14330 | | | | | 0,90 | 12,84 | | | | | | | 1,17 | 16,63 | 1,02 | 14,47 |
| 7000 | 15430 | | | | | 0,97 | 13,83 | | | | | | | | | 1,10 | 15,58 |
| 7500 | 16535 | | | | | 1,04 | 14,82 | | | | | | | | | | |
| 8000 | 17635 | | | | | 1,11 | 15,80 | | | | | | | | | | |
| 8500 | 18740 | | | | | | | | | | | | | | | | |
| 9000 | 19840 | | | | | | | | | | | | | | | | |
| 9500 | 20945 | | | | | | | | | | | | | | | | |

*) CONTACT AREA CALCULATED BY USING A FORMULA BY THE SWEDISH FORESTRY RESEARCH INSTITUTE (SKOGSARBETEN).

CONTACT AREA AND GROUND PRESSURE AT DIFFERENT TYRE LOADS. SOFT SOIL.

| | | 16.9-28 | | 16.9-30 | | 16.9-34 | | 18.4-34 | | 18.4-38 | | 20.8-38 | |
|------------------------|-----------|--------------------------|--------------------------|--------------------------|--------------------------|--------------------------|--------------------------|--------------------------|--------------------------|--------------------------|--------------------------|--------------------------|--------------------------|
| | | mm | in | mm | in | mm | in | mm | in | mm | in | mm | in |
| Diameter | | 1435 | 56,5 | 1485 | 58,5 | 1585 | 62,4 | 1650 | 65,0 | 1750 | 68,9 | 1840 | 72,4 |
| Width | | 429 | 16,9 | 429 | 16,9 | 429 | 16,9 | 467 | 18,4 | 467 | 18,4 | 528 | 20,8 |
| | | cm ² | in ² | cm ² | in ² | cm ² | in ² | cm ² | in ² | cm ² | in ² | cm ² | in ² |
| Contact area *) | | 3080 | 477,37 | 3190 | 494,42 | 3400 | 526,97 | 3850 | 596,71 | 4090 | 633,909 | 4860 | 753,25 |
| Load | | Ground pressure | | Ground pressure | | Ground pressure | | Ground pressure | | Ground pressure | | Ground pressure | |
| kg | lb | kg/cm² | lb/in² | kg/cm² | lb/in² | kg/cm² | lb/in² | kg/cm² | lb/in² | kg/cm² | lb/in² | kg/cm² | lb/in² |
| 500 | 1100 | 0,16 | 2,30 | 0,16 | 2,22 | 0,15 | 2,09 | 0,13 | 1,84 | 0,12 | 1,74 | 0,10 | 1,46 |
| 1000 | 2205 | 0,32 | 4,62 | 0,31 | 4,46 | 0,29 | 4,18 | 0,26 | 3,70 | 0,24 | 3,48 | 0,21 | 2,93 |

| | | | | | | | | | | | | | |
|------|-------|------|-------|------|-------|------|-------|------|-------|------|-------|------|-------|
| 1500 | 3305 | 0,49 | 6,92 | 0,47 | 6,68 | 0,44 | 6,27 | 0,39 | 5,54 | 0,37 | 5,21 | 0,31 | 4,39 |
| 2000 | 4410 | 0,65 | 9,24 | 0,63 | 8,92 | 0,59 | 8,37 | 0,52 | 7,39 | 0,49 | 6,96 | 0,41 | 5,85 |
| 2500 | 5510 | 0,81 | 11,54 | 0,78 | 11,14 | 0,74 | 10,46 | 0,65 | 9,23 | 0,61 | 8,69 | 0,51 | 7,31 |
| 3000 | 6615 | 0,97 | 13,86 | 0,94 | 13,38 | 0,88 | 12,55 | 0,78 | 11,09 | 0,73 | 10,44 | 0,62 | 8,78 |
| 3500 | 7715 | 1,14 | 16,16 | 1,10 | 15,60 | 1,03 | 14,64 | 0,91 | 12,93 | 0,86 | 12,17 | 0,72 | 10,24 |
| 4000 | 8820 | | | | | 1,18 | 16,74 | 1,04 | 14,78 | 0,98 | 13,91 | 0,82 | 11,71 |
| 4500 | 9920 | | | | | | | 1,17 | 16,62 | 1,10 | 15,65 | 0,93 | 13,17 |
| 5000 | 11025 | | | | | | | | | | | 1,03 | 14,64 |
| 5500 | 12125 | | | | | | | | | | | 1,13 | 16,10 |
| 6000 | 13230 | | | | | | | | | | | | |
| 6500 | 14330 | | | | | | | | | | | | |
| 7000 | 15430 | | | | | | | | | | | | |
| 7500 | 16535 | | | | | | | | | | | | |
| 8000 | 17635 | | | | | | | | | | | | |
| 8500 | 18740 | | | | | | | | | | | | |
| 9000 | 19840 | | | | | | | | | | | | |
| 9500 | 20945 | | | | | | | | | | | | |

***) CONTACT AREA CALCULATED BY USING A FORMULA BY THE SWEDISH FORESTRY RESEARCH INSTITUTE (SKOGSARBETEN).**

CONTACT AREAS ON A HARD DRIVING SURFACE

TRI patterns have a significantly larger net contact area compared with traditional tractor drive tires. This results in significant improvement in friction rate, grip, and wear rate.

GROUND CONTACT AREA RATIOS

**NORMAL TRACTOR
DRIVE TIRE**

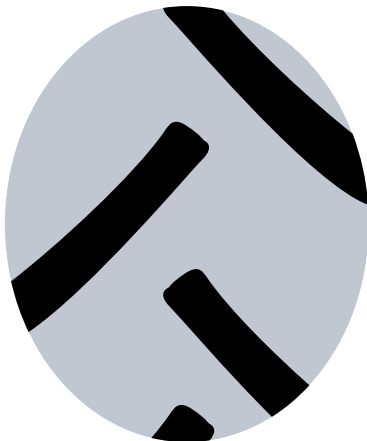

20-25 % net contact area

**NORMAL SECTION
TRI**



42 % net contact area

**80 SERIES
TRI 2**

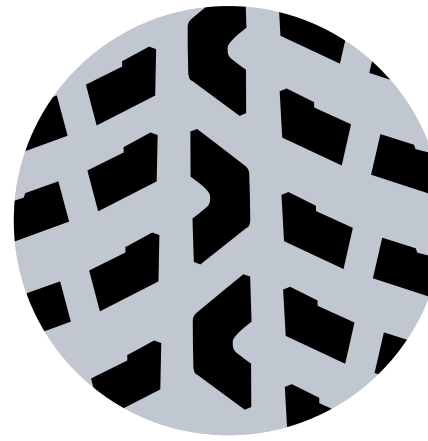

39% net contact area

**80 SERIES
HAKKAPELIITTA TRI**

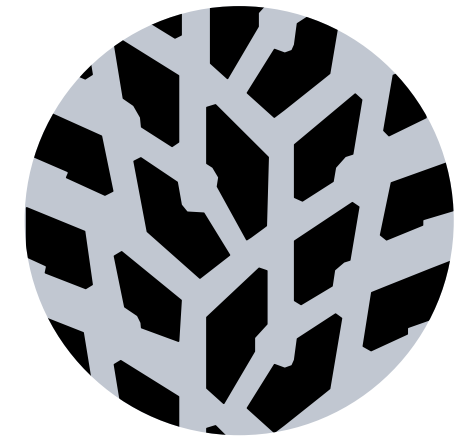

45 % net contact area

CONTACT AREA ON HARD SURFACE

The deflection takes place only on the tire and not at all on the ground. The values in the table are valid at the nominal load and air pressure conditions.

CONTACT AREA ON SOFT SOIL

The deflection takes place mainly on the ground: the tire sinks 15% of its diameter into ground, but the deflection will recover to half of the original value. It is impossible to compare actual measurements in different places, but comparison between different tire sizes is possible with the help of the table below.

Compared to the corresponding standard dimension TRI 2 tire commonly gives an appr. 5–10% larger contact area.

65 series tires will give an approximately 20–30% larger area compared to corresponding sizes with a normal section.

NOKIAN TYRES TRI 2

| Size | Contact area | | | |
|------------------|-----------------|-----------------|-----------------|-----------------|
| | Hard surface | | Soft surface | |
| | cm ² | in ² | cm ² | in ² |
| 85-series | | | | |
| 320/85R28 | 806 | 125 | 1 994 | 309 |
| 80-series | | | | |
| 250/80R16 | 376 | 58 | 1 091 | 169 |
| 340/80R18 | 711 | 110 | 1 717 | 266 |
| 360/80R20 | 810 | 126 | 1 950 | 302 |
| 300/80R24 | 674 | 104 | 1 608 | 249 |
| 340/80R24 | 755 | 117 | 1 980 | 307 |
| 360/80R24 | 458 | 131 | 2 115 | 328 |
| 400/80R24 | 1 035 | 160 | 2 525 | 391 |
| 440/80R24 | 1 200 | 186 | 2 895 | 449 |
| 360/80R28 | 947 | 147 | 2 324 | 360 |
| 400/80R28 | 1 065 | 165 | 2 730 | 423 |
| 440/80R28 | 1 270 | 197 | 3 120 | 484 |
| 440/80R30 | 1 290 | 200 | 3 230 | 501 |
| 480/80R30 | 1 515 | 235 | 3 665 | 568 |
| 440/80R34 | 1 375 | 213 | 3 445 | 535 |
| 480/80R34 | 1 590 | 246 | 3 910 | 606 |
| 480/80R38 | 1 645 | 255 | 4 150 | 643 |
| 540/80R38 | 2 030 | 315 | 5 030 | 780 |
| 620/80R42 | 2 743 | 425 | 6 434 | 997 |
| 75-series | | | | |
| 270/75R15 | 371 | 58 | 1 086 | 168 |
| 250/75R16 | 323 | 50 | 1 009 | 156 |
| 70-series | | | | |

| Size | Contact area | | | |
|------------------|-----------------|-----------------|-----------------|-----------------|
| | Hard surface | | Soft surface | |
| | cm ² | in ² | cm ² | in ² |
| 360/70R20 | 735 | 114 | 1 835 | 284 |
| 500/70R24 | 1 523 | 236 | 3 608 | 559 |
| 65-series | | | | |
| 420/65R24 | 960 | 149 | 2 415 | 374 |
| 460/65R24 | 1 178 | 183 | 2 742 | 425 |
| 540/65R24 | 1 523 | 236 | 3 608 | 559 |
| 480/65R28 | 1 352 | 210 | 3 086 | 478 |
| 540/65R28 | 1 639 | 254 | 3 740 | 580 |
| 540/65R30 | 1 698 | 263 | 3 867 | 599 |
| 600/65R38 | 2 239 | 347 | 4 976 | 771 |
| 650/65R38 | 2 524 | 391 | 5 657 | 877 |
| 650/65R42 | 2 666 | 413 | 5 953 | 923 |

NOKIAN TYRES TRI

| Size | Contact area | | | |
|--------------------|-----------------|-----------------|-----------------|-----------------|
| | Hard surface | | Soft surface | |
| | cm ² | in ² | cm ² | in ² |
| 11.2R24 | 530 | 82 | 1 530 | 237 |
| 16.9R24 | 1 130 | 175 | 2 810 | 436 |
| 16.9R30 | 1 180 | 183 | 3 130 | 485 |
| 18.4R30 | 1 440 | 223 | 3 570 | 533 |
| 65-series | | | | |
| 420/65R24 | 940 | 146 | 2 370 | 367 |
| 460/65R24 | 1 040 | 161 | 2 650 | 411 |
| 480/65R24 | 1 150 | 178 | 2 910 | 451 |
| 520/65R24 | 1 430 | 222 | 3 410 | 529 |
| 480/65R28 | 1 145 | 177 | 3 070 | 476 |
| 600/65R38 | 2 110 | 327 | 5 020 | 778 |
| Bias Beltet | | | | |
| 18.4B30 | 1 440 | 223 | 3 575 | 544 |
| 580/65B30 | 1 870 | 290 | 4 440 | 688 |
| 580/65B34 | 1 990 | 308 | 4 730 | 733 |

STUDS AND CHAINS

STUDS

Nokian Tyres TRI 2, Nokian Tyres TRI, Nokian Tyres Hakkapeliitta Loader and Nokian Tyres Loader Grip patterns offer an excellent winter grip. To gain even more traction and grip in extreme wet icy conditions the tires can be studded. The following schematic pictures show the studding sequence.

STUD RECOMMENDATION

- Recommended types are truck, tractor or construction machine studs
- Maximum stud length is 25 mm / 1 in
- Minimum stud flange is 9 mm / 11/32 in

STUD DIMENSIONING EXAMPLES

| Stud marking | Stud length | | Flange diameter | | Stud hole diameter | | Stud protusion | |
|--------------|-------------|-------|-----------------|-------|--------------------|------|----------------|------|
| | mm | in | mm | in | mm | in | mm | in |
| 9 - 15 | 15 | 19/32 | 9 | 11/32 | 4 | 5/32 | 2 | 3/32 |
| 11 - 15 | 15 | 19/32 | 11 | 14/32 | 5 | 6/32 | 2 | 3/32 |
| 11 - 17 | 17 | 21/32 | 11 | 14/32 | 5 | 6/32 | 2.5 | 3/32 |
| 12 - 17 | 17 | 21/32 | 12 | 15/32 | 5 | 6/32 | 2.5 | 3/32 |
| 12 - 20 | 20 | 25/32 | 12 | 15/32 | 5 | 6/32 | 3 | 4/32 |
| 12 - 24 | 24 | 30/32 | 12 | 15/32 | 6 | 8/32 | 3 | 4/32 |
| 16 - 19 | 19 | 24/32 | 16 | 20/32 | 7 | 9/32 | 2.5 | 3/32 |

NOKIAN TYRES HAKKAPELIITTA TRI

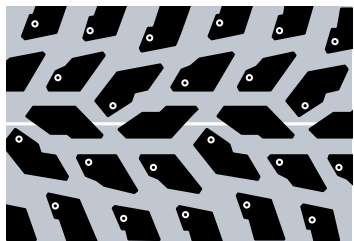

Stud places marked

NOKIAN TYRES TRI 65 SERIES

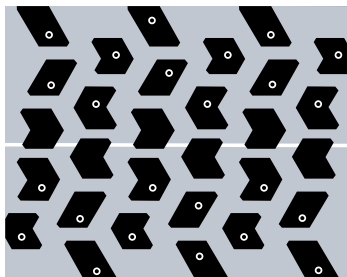

NOKIAN TYRES TRI

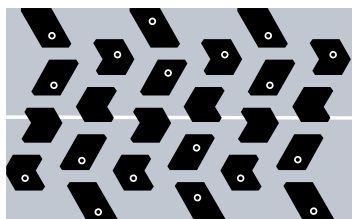

NOKIAN TYRES GROUND KING



NOKIAN TYRES TRI 2

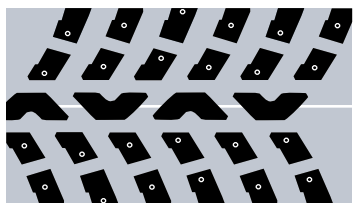

**NOKIAN TYRES HAKKAPELIITTA
LOADER**

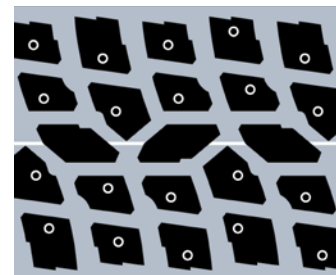

NOKIAN TYRES LOADER GRIP

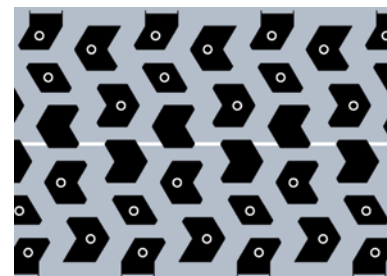

NUMBER OF STUDS - NOKIAN TYRES TRI 2

| Size | Pattern | Number of studs |
|------------------|---------|-----------------|
| 85-series | | |
| 320/85R28 | TRI 2 | 168 |
| 80-series | | |
| 250/80R16 | TRI 2 | 144 |
| 340/80R18 | TRI 2 | 144 |
| 360/80R20 | TRI 2 | 144 |
| 300/80R24 | TRI 2 | 168 |
| 340/80R24 | TRI 2 | 168 |
| 360/80R24 | TRI 2 | 168 |
| 400/80R24 | TRI 2 | 168 |
| 440/80R24 | TRI 2 | 168 |
| 360/80R28 | TRI 2 | 168 |
| 400/80R28 | TRI 2 | 168 |
| 440/80R28 | TRI 2 | 168 |
| 440/80R30 | TRI 2 | 168 |
| 480/80R30 | TRI 2 | 168 |
| 440/80R34 | TRI 2 | 192 |
| 480/80R34 | TRI 2 | 192 |
| 480/80R38 | TRI 2 | 192 |
| 540/80R38 | TRI 2 | 192 |
| 620/80R42 | TRI 2 | 192 |

| Size | Pattern | Number of studs |
|------------------|---------|-----------------|
| 75-series | | |
| 270/75R15 | TRI 2 | 144 |
| 250/75R16 | TRI 2 | 144 |
| 70-series | | |
| 360/70R20 | TRI 2 | 144 |
| 500/70R24 | TRI 2 | 168 |
| 600/70R34 | TRI 2 | 192 |
| 710/70R42 | TRI 2 | 192 |
| 65-series | | |
| 420/65R24 | TRI 2 | 168 |
| 460/65R24 | TRI 2 | 168 |
| 540/65R24 | TRI 2 | 168 |
| 480/65R28 | TRI 2 | 168 |
| 540/65R28 | TRI 2 | 168 |
| 540/65R30 | TRI 2 | 168 |
| 600/65R34 | TRI 2 | 192 |
| 600/65R38 | TRI 2 | 192 |
| 650/65R38 | TRI 2 | 192 |
| 650/65R42 | TRI 2 | 192 |

NUMBER OF STUDS - NOKIAN TYRES TRI

| Size | Pattern | Number of studs |
|--------------------|---------|-----------------|
| 65-series | | |
| 460/65R24 | TRI | 176 |
| 480/65R24 | TRI | 184 |
| Bias Beltet | | |
| 18.4B34 | TRI | 144 |
| 580/65B30 | TRI | 184 |
| 580/65B34 | TRI | 192 |

NUMBER OF STUDS - NOKIAN TYRES HAKKAPELIITTA TRI

| Size | Number of studs | Max. stud flange diameter (mm) | Max. stud height (mm) |
|-----------|-----------------|--------------------------------|-----------------------|
| 400/60R18 | 120 | 9 | 20 |
| 340/80R18 | 120 | 9 | 20 |
| 360/80R20 | 144 | 9 | 20 |
| 400/70R20 | 168 | 9 | 24 |
| 420/65R24 | 168 | 9 | 24 |
| 360/80R24 | 168 | 9 | 24 |
| 400/80R24 | 168 | 9 | 24 |
| 440/80R24 | 168 | 9 | 24 |
| 460/70R24 | 144 | 12 | 25 |
| 500/70R24 | 144 | 12 | 25 |
| 540/70R24 | 144 | 12 | 25 |
| 400/80R28 | 168 | 9 | 24 |
| 440/80R28 | 168 | 12 | 25 |
| 540/65R28 | 168 | 12 | 25 |
| 540/65R30 | 168 | 12 | 25 |
| 440/80R34 | 192 | 12 | 25 |
| 480/80R34 | 192 | 12 | 25 |
| 600/70R32 | 192 | 12 | 25 |
| 480/80R38 | 192 | 12 | 25 |
| 540/80R38 | 192 | 12 | 25 |
| 650/65R38 | 192 | 12 | 25 |
| 650/65R42 | 192 | 12 | 25 |

NUMBER OF STUDS - NOKIAN TYRES LOADER GRIP

| Size | Number of studs |
|---------|-----------------|
| 17.5R25 | 180 |
| 20.5R25 | 180 |
| 23.5R25 | 172 |

NUMBER OF STUDS - NOKIAN TYRES HAKKAPELIITTA LOADER

| Size | Number of studs |
|----------|-----------------|
| 14.00R24 | 168 |
| 17.5R25 | 168 |
| 20.5R25 | 168 |
| 23.5R25 | 168 |

CHAINS

It is recommended to use chains only for short periods at a time. Chains shorten the tire lifetime. Nokian Heavy Tyres limited warranty doesn't cover any damages made by accessories including the use of chains.

The use of chains comes into question when extreme conditions require additional grip. Then it is recommended to use chains only at low speeds and remove them when they are not needed anymore (i.e. road transit).

Before installing chains inspect them for sharp edges or welding burs.

Ensure that the chains are at the right tightness. Chains too loose can slip on the tire and cause excessive wear.

It is important to check that no chain rings are broken or that no individual rings have turned so that calks cut into the tire. Calks can cut into the tire also when chains are severely worn and over stretched.

MPT AGILE STUD RECOMMENDATIONS

1) NOKIAN TYRES MPT AGILE TIRES ARE PART OF THE TRUCK TIRE NORM. THEREFORE:

Recommended stud for truck tires has a length of 15 mm / 19/32 nds of an inch and flange diameter of 11 mm / 14/32 nds of inch.

| Stud | | | | Drilled stud hole | | | |
|--------|-----------|-----------------|-----------|-------------------|-----------|-------|-----------|
| Length | | Flange diameter | | Diameter | | Depth | |
| mm | 32 nds in | mm | 32 nds in | mm | 32 nds in | mm | 32 nds in |
| 15 | 19 | 11 | 14 | 5 | 6 | 13 | 16 |

2) STUD AMOUNT IN TIRES (EU / SINCE 1ST JULY 2009):

Maximum of 50 pcs of studs allowed for every 1 m / 39,4 inch of tire circumference.

WITH THE MPT AGILE PATTERN TYPE, THE AMOUNT OF STUDS:

| | |
|----------------------|--|
| 365/80R20 MPT Agile | 171 pcs max (evenly distributed 168 pcs) |
| 14.00R20 MPT Agile | 198 pcs max (evenly distributed 192 pcs) |
| 14 00R20 MPT Agile 2 | 198 pcs max (evenly distributed 182 pcs) |

TRUCK TIRE STUD (MAX. 5 G / 0.18 OZ)

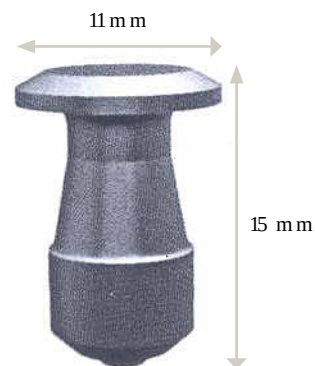

STUD PLACES IN MPT TIRES



O = Normal stud places, 144 in total
 X = Additional stud places, 72 pcs

Notice! Please check your local legislation on stud use.

MOUNTING TIRES ON FOUR WHEEL DRIVE TRACTORS

The mounting of tires on a four wheel drive tractor must be done with great care in order to produce the best driving results and maintain the tires' service life. Generally, the actual rolling circumference of a front tire should be 1–4 % higher than the rolling circumference calculated using the gear ratio. Excessive traction in the front tires can cause quick wear and reduce mileage, while insufficient traction in the front tires will make the tractor more difficult to steer. Check the manual of the tractor in question for detailed instructions on the calculation of rolling circumferences (gear ratio). When changing the tire size or type, always check the relationship between the rolling circumferences and make sure that the combination is within the limits given by the manufacturer.

EXAMPLES OF THE CALCULATION

The basis for the calculation is the gear ratio between the front and rear axle, with which the rolling circumference of the required front tire can be calculated.

EXAMPLE 1: CALCULATING THE ROLLING CIRCUMFERENCE OF FRONT TIRES

| Tire size | Rolling circumference (from tire manufacturer) |
|-------------|--|
| 16.9R28 TRI | 4222 mm |
| 20.8R38 TRI | 5448 mm |

Tractor gear ratio: 1.329. The target is 1–5% traction (lead) for front tires.

5448 mm (rear tire rolling circumference) / 1.329 (gear ratio) = 4099 mm (no traction)

| | |
|--------------|--------------------------|
| 1% traction: | 1.01 x 4099 mm = 4140 mm |
| 5% traction: | 1.05 x 4099 mm = 4304 mm |

The selected tire 16.9R28 TRI has a rolling circumference (4140 mm < 4222 mm < 4303 mm) which is within the limit given by the manufacturer. The front tire's traction is 4222 / 4099 = 1.030, i.e. 3.0%.

EXAMPLE 2: SWITCHING TO TRI 2 TIRES ON THE ABOVE MENTIONED MACHINE

Gear ratio: 1.329. The target is 1–5% traction for the front tire.

The control calculation must be verified. It must be noted as well that the TRI 2 and TRI tires have a different rolling circumference than a correspondent tire with a lug pattern.

| Tire size | Rolling circumference (from tire manufacturer) |
|-----------------|--|
| 440/80R28 TRI 2 | 4266 mm |
| 540/80R38 TRI 2 | 5529 mm |

Verification:

5529 mm (rear tire rolling circumference) / 1.329 (gear ratio) = 4160 mm (traction 0%)

| | |
|--------------|--------------------------|
| 1% traction: | 1.01 x 4160 mm = 4202 mm |
| 5% traction: | 1.05 x 4160 mm = 4368 mm |

The selected tire 440/80R28 has a rolling circumference (4202 mm < 4266 mm < 4368 mm)

which is within the limit given by the manufacturer.

The front tire's traction is $4266 / 4160 = 1.025$, i.e. 2.5%.

The methods above can be used to check the suitability of new tires when mounting them on a tractor with a known gear ratio. However, if this vital information is not available, you should contact the tractor's manufacturer or importer.

MINE TIRE MAINTENANCE

To utilise the full capacity of a mining tire, it is recommended to check the inflation pressure at least once a week. Keeping the pressure at a sufficient level prevents tire break-up caused by high heat generation. Pressure maintenance reduces cuts and cracks on tire sidewalls by keeping the tire contour in design width.

It is also recommended to keep a tire check diary. This makes it easier to determine the interval and the need for maintenance. A diary helps maintenance when machines are operated in several shifts and by different operators. Regular check-ups help in starting repair procedures early enough to save in tire costs.

When checking the inflation pressure, please observe also the tire temperature. A rise of 10 degrees centigrade / 50 Fahrenheit will increase the inflation pressure approximately 0,35 bar / 5,1 psi at 10 bar pressure level. Use only reliable and calibrated pressure gauges. A regular gauge re-calibration should also be performed.

A cut on a tire sidewall, caused in example by sharp stones, should always be repaired before it proceeds to let moisture reach into the tire reinforcing cords.

Narrow mine tunnels often wear tread more from the outer side of a tire. It is recommended to swap tires from one side to the other to gain more tire hours.

The Nokian Tyres Mine L-5S features a tread wear indicator. Besides this it is also recommended to mark the actual tread wear (mm / in) into the tire check diary.

In handling a TL (tubeless) tire make sure that the rim is not damaged. Even a small abrasion on a tire by a damaged or a faulty rim can lead to excessive air leak. A defective rim is always a serious safety hazard. With a TL tire always use a tubeless rim.

Notice! Regular inflation pressure maintenance ensures long service life.

HAKKAPELIITTA LOADER INFLATION PRESSURE RECOMMENDATIONS FOR DIFFERENT WHEEL LOADERS

SIZE: 17.5R25

| Manufacturer | Model | Empty vehicle weight | | Tipping load static | | Inflation pressure Front axle | | Inflation pressure Rear axle | |
|--------------|------------|----------------------|--------|---------------------|--------|-------------------------------|-----|------------------------------|-----|
| | | kg | lb | kg | lb | kPa | psi | kPa | psi |
| CAT | IT14G* | 8 450 | 18 629 | 4 500 | 9 921 | 375 | 54 | 225 | 33 |
| CAT | 914K* | 8 181 | 18 036 | 5 578 | 12 297 | 375 | 54 | 225 | 33 |
| CAT | 924H | 11 730 | 25 860 | 8 740 | 19 268 | 450 | 65 | 300 | 44 |
| JCB | 411 & 413S | 8 830 | 19 467 | 6 610 | 14 573 | 375 | 54 | 225 | 33 |
| JCB | 417S ZX | 9 510 | 20 966 | 7 250 | 15 984 | 400 | 58 | 225 | 33 |
| JCB | 418S ZX | 9 600 | 21 164 | 7 240 | 15 962 | 400 | 58 | 250 | 36 |
| Liebherr | L524 | 11 100 | 24 471 | 8 500 | 18 739 | 475 | 69 | 300 | 44 |
| Liebherr | L528 | 11 500 | 25 353 | 9 560 | 21 076 | 500 | 73 | 325 | 47 |
| Ljungby | L9 | 10 500 | 23 146 | 6 500 | 14 330 | 450 | 65 | 300 | 44 |
| Volvo | L60H | 12 400 | 27 337 | 6 570 | 14 484 | 500 | 73 | 300 | 44 |

ASSUMPTIONS: Normal bucket. Max speed with full bucket 12.5 mph / *20 mph. Max speed with empty vehicle 25 mph.

ASSUMPTIONS: Normal bucket. Max speed with full bucket 20 km/h / *30 km/h. Max speed with empty vehicle 40 km/h

SIZE: 20.5R25

| Manufacturer | Model | Empty vehicle weight | | Tipping load static | | Inflation pressure Front axle | | Inflation pressure Rear axle | |
|--------------|-------|----------------------|--------|---------------------|--------|-------------------------------|-----|------------------------------|-----|
| | | kg | lb | kg | lb | kPa | psi | kPa | psi |
| CAT | 930K | 14 400 | 31 747 | 10 100 | 22 267 | 400 | 58 | 275 | 40 |
| CAT | 938K | 16 350 | 36 046 | 12 200 | 26 896 | 475 | 69 | 300 | 44 |
| Komatsu | 270-7 | 13 100 | 28 881 | 10 100 | 22 267 | 350 | 51 | 225 | 33 |
| Komatsu | 320-7 | 16 000 | 35 274 | 11 560 | 25 485 | 450 | 65 | 300 | 44 |
| Liebherr | L538 | 13 400 | 29 542 | 10 700 | 23 590 | 375 | 54 | 250 | 36 |
| Liebherr | L542 | 14 000 | 30 865 | 11 600 | 25 574 | 400 | 58 | 275 | 40 |
| Volvo | L70H | 14 480 | 31 923 | 9 860 | 21 738 | 400 | 58 | 275 | 40 |
| Volvo | L90H | 15 990 | 35 252 | 11 470 | 25 287 | 450 | 65 | 300 | 44 |

ASSUMPTIONS: Normal bucket. Max speed with full bucket 12.5 mph. Max speed with empty vehicle 25 mph.

ASSUMPTIONS: Normal bucket. Max speed with full bucket 20 km/h. Max speed with empty vehicle 40 km/h

SIZE: 23.5R25

| Manufacturer | Model | Empty vehicle weight | | Tipping load static | | Inflation pressure Front axle | | Inflation pressure Rear axle | |
|--------------|-----------------------|----------------------|--------|---------------------|--------|-------------------------------|-----|------------------------------|-----|
| | | kg | lb | kg | lb | kPa | psi | kPa | psi |
| CAT | 950K | 20 131 | 44 381 | 13 719 | 30 245 | 450 | 65 | 300 | 44 |
| CAT | 962M | 20 226 | 44 591 | 13 358 | 29 449 | 450 | 65 | 300 | 44 |
| Komatsu | WA380-6 | 17 583 | 38 764 | 14 563 | 32 106 | 375 | 54 | 200 | 29 |
| Komatsu | WA430-6 | 18 533 | 40 858 | 14 963 | 32 998 | 400 | 58 | 225 | 33 |
| Liebherr | L550 | 16 590 | 36 575 | 13 204 | 29 110 | 350 | 51 | 225 | 33 |
| Ljungby | L18, Tier IIIB engine | 19 000 | 41 888 | 13 900 | 30 644 | 425 | 62 | 275 | 40 |
| Volvo | L110G | 18 405 | 40 576 | 14 401 | 31 749 | 375 | 54 | 225 | 33 |
| Volvo | L120F | 20 010 | 44 116 | 14 540 | 32 055 | 450 | 65 | 300 | 44 |

ASSUMPTIONS: Normal bucket. Max speed with full bucket 12.5 mph / *20 mph. Max speed with empty vehicle 25 mph.

ASSUMPTIONS: Normal bucket. Max speed with full bucket 20 km/h / *30 km/h. Max speed with empty vehicle 40 km/h

STUDS

Nokian Tyres Hakkapeliitta Loader pattern offers an excellent winter grip. To gain even more traction and grip in extreme wet icy conditions the tires can be studded. The following schematic picture shows the studding sequence

STUD RECOMMENDATION

- Recommended types are truck, tractor or construction machine studs
- Maximum stud length is 25 mm / 1 in
- Minimum stud flange is 9 mm / 11/32 in

NUMBER OF STUDS

| Size | Number of studs |
|----------|-----------------|
| 14.00R24 | 168 |
| 17.5R25 | 168 |
| 20.5R25 | 168 |
| 23.5R25 | 168 |

NOKIAN TYRES HAKKAPELIITTA LOADER

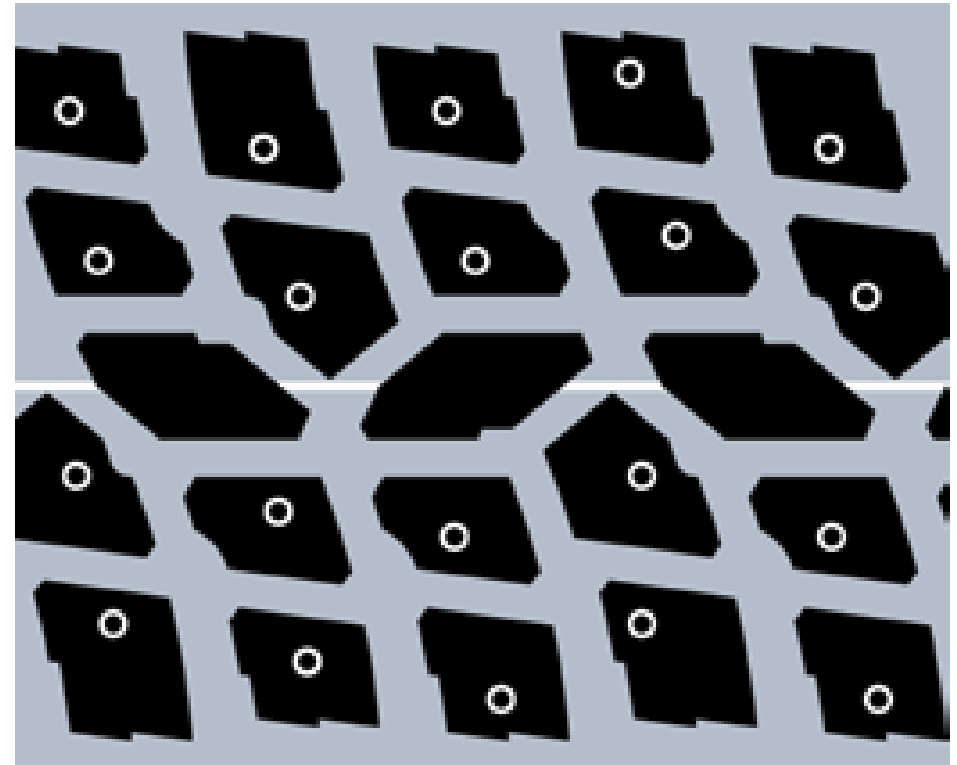

Stud places marked.

GROUND KARE AND EXCAVATOR MOUNTING RECOMMENDATIONS

Nokian Tyres 24PR Excavator and Nokian Tyres Ground Kare tires are developed for high load capacities with a maximum inflation pressure of 600 kPa. Nokian Tyres 20PR Excavator tires are developed for high load capacities with a maximum inflation pressure of 450 kPa.

Please note that the wheel's load capacity must meet the machine requirements. The tire mounted on the wheel must have a high enough load capacity as well. Also make sure that the wheel's maximum inflation pressure capability meets the allowed maximum pressure of the tire.

As stated by the ETRTO, consult the rim and wheel manufacturers for load capacity compatibility ("Standards Manual 2019", p. R.4 "General Notes. Strength.")

The rim's horn (or flange) shall have a shape that does not damage a tire during mounting. Such rims have: a round/tube shape horn or a well bent down/long horn. For the rim's horn suitability, please consult the tire manufacturer.

The rim's contour has to meet ETRTO requirements ("15° Drop-Centre Rims Width Codes AG Contour. Basic Contour" p. R.36, ETRTO 2019). Additionally the diagonal mounting distance has to meet the requirements set by the ETRTO (Engineering Design Information 2019 p. RM.2 "Contour changes of drop-center rims"). For the rim's contour suitability, please contact the tire manufacturer.

Mounting Nokian Tyres Excavator and Nokian Tyres Ground Kare tires always requires a two clamp mounting method by Nokian Tyres. For the bigger clamp, please always use HTTMC00001 clamp developed by Nokian Tyres.

RECOMMENDED SHAPE:

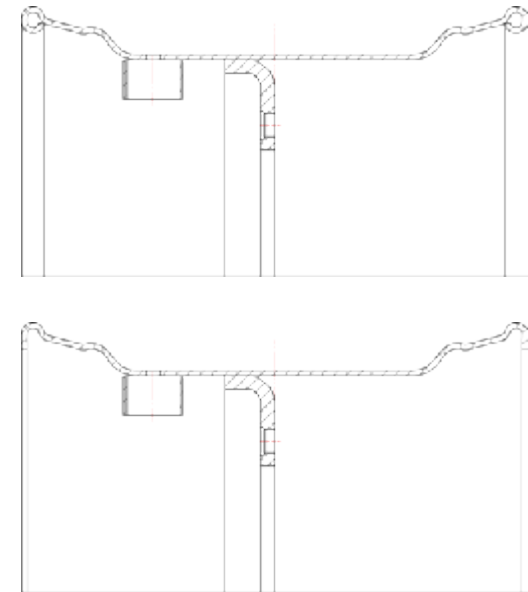

NON-RECOMMENDED SHAPE:

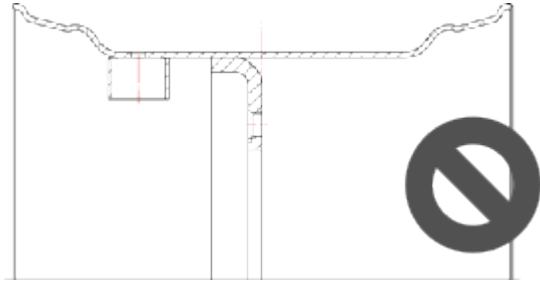



NOKIAN TYRES INTUITU™ SMART TIRES

Digital tires are the key to more efficient, safer and more sustainable working. With Nokian Tyres Intuitu™ smart tires and mobile app, you always know how your tires are doing – from one tire to the entire fleet.

nokian
TYRES

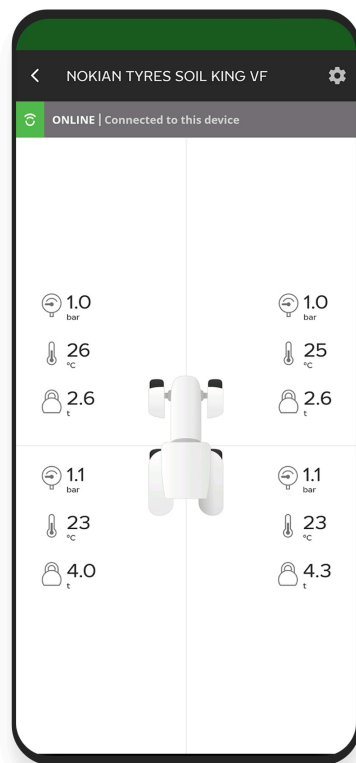

Designed and developed by Nokian Tyres, the Nokian Tyres Intuitu sensor measures tire pressure, temperature and load* directly from the inside surface of the tire. It sends measurements every minute via Bluetooth to the Nokian Tyres Intuitu mobile app.

When the app detects abnormal tire conditions, it alerts the user. With the power of the Intuitu cloud, all drivers and fleet managers can see the condition of all fleet tires remotely (internet connection required).

MORE SAVINGS

Smart tire pressure monitoring is important for grip and stability as well as fuel consumption and tire service life. With Nokian Tyres Intuitu, you can be sure you'll get the most out of your tire investment.

MORE SAFETY

High tire temperatures are linked to tire damage and are a safety risk. Nokian Tyres Intuitu tire monitoring system alerts you on time, making your entire operation more informed, safer and sustainable.

MORE WARRANTY

By registering your tires on Nokian Tyres Intuitu, you will get a one-year extension to normal tire

warranty and a direct communication channel with Nokian Tyres.

TECHNICAL SPECIFICATION

| | |
|-----------------------------|--|
| Operating temperature range | -40 to 80°C (+/- 2 °C) (-40 °C to -20 °C with limited functionality and performance) |
| Pressure measurement range | 0-9 bar (+/- 0.04 bar) |
| Load measurement* | +/- 5 % accuracy 6-30 km/h |
| Connection to mobile phone | Bluetooth low energy |
| Sensor battery life | 10 000 active hours typical usage. Non-replaceable battery |
| Phone operating systems | Android 8 onwards iOS 11 onwards |
| Alarms | Low pressure, high temperature, high speed |

* Intuitu 2.0 only

Notice! Do not use with liquids or inert tubes in the tire. For more detailed information and FAQs, please go to www.nokiantyres.com/intuitu

Nokian Tyres Intuitu available with: *Nokian Tyres Float King VF, Nokian Tyres Ground King, Nokian Tyres Tractor King, Nokian Tyres TRI 2, Nokian Tyres Hakkapeliitta TRI, Nokian Tyres Country King, Nokian Tyres CT, Nokian Tyres Excavator, Nokian Tyres Ground Kare*

Nokian Tyres Intuitu 2.0 available with: *Nokian*

Tyres Soil King VF

REGROOVING OF NOKIAN TYRES TRUCK & BUS TIRES

INTRODUCTION

Tire regrooving extends the life cycle of Nokian Tyres steel radial tires for buses and trucks. Tire regrooving can be done on new tires by cutting into the tread as instructed by Nokian Tyres.

To ensure safety and minimize tire damages, the following should be taken into account:

- Only professional operators should perform the regrooving process.
- Only competent tools suitable for the process should be used with electrically heated blades.
- The blades in the cutter heads need to be set to the correct, specified depth.
- The blade setting depth for each individual tire must be determined by referring to the information charts presented in this technical manual in order to prevent the appearance of plies at the bottom of the tread and damage to the tire structure.
- The heating of the blade begins automatically when the blade pierces the rubber.
- The cutter must be held in a way that the underside of the cutting head is flat against the tread surface when regrooving.
- During the regrooving process, a minimum depth of leftover under-tread rubber is required to avoid injuries of the top steel belt, stone-chips as well as groove cracking that can cause rib tears.

GUIDELINES

- 1. Before regrooving, tires must be demounted from the wheel completely**
- 2. Inspections the tires must include following steps:**
 - Before regrooving, possible damages on any part of the tire must be checked carefully.
 - When selecting a tire for regrooving, special attention needs to be paid to the tire condition when the tread area is in any way damaged. This includes for example chipping, tearing and cutting due to abnormal operating conditions.
 - Stones and other foreign objects, such as nails and other sharp objects, that may have embedded into the tire grooves must be removed. If needed, the possible damages from the foreign objects must be repaired before starting the regrooving process.
 - When a tire is abnormally or intensely worn, regrooving the worn parts of the tire may still be possible if an adequate amount of the original groove is visible before regrooving.
- 3. The minimum remaining tread depth of the tire should be between 3–4 mm before regrooving.**
 - To find the minimum remaining depth, the tread depth must be measured carefully at 4 different places around the tire circumference.
 - The cutter blade needs to be set for the recommendations as shown in the information charts of this technical manual.
- 4. The regrooved tire should be free from all defects and injuries.**
 - To ensure complete safety, it is extremely important to confirm that the belts under the regrooved tread are not exposed in any parts.

EXAMPLE:

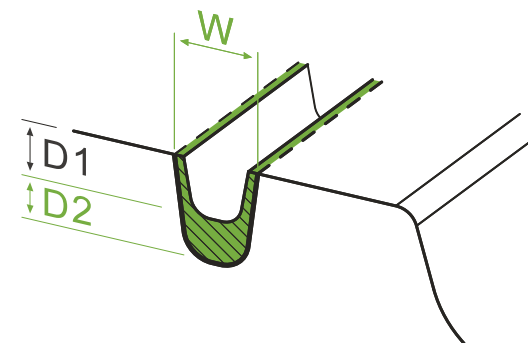

Minimum remaining tread depth = 3 mm (D1)

Recommended regrooving depth = 3 mm (D2)

Depth to which cutter blade is set = 6 mm (D1+D2)

Recommended regrooving width = W

REGROOVING RECOMMENDATIONS

THE MAXIMUM RECOMMENDED DEPTH IS THE INCREASING DEPTH.

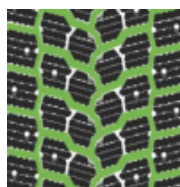

NOKIAN TYRES HAKKAPELIITTA TRUCK E2

| Tire size | Regrooving depth | Width of regrooving | Blade |
|-------------|------------------|---------------------|-------|
| 275/70R22.5 | 2.5 mm | 7-8 mm | R3 |
| 295/80R22.5 | 3.0 mm | 7-8 mm | R3 |
| 315/70R22.5 | 2.5 mm | 7-8 mm | R3 |
| 315/80R22.5 | 3.0 mm | 7-8 mm | R3 |

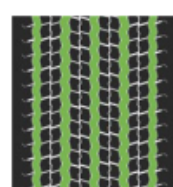

NOKIAN TYRES HAKKAPELIITTA TRUCK F2

| Tire size | Regrooving depth | Width of regrooving | Blade |
|-------------|------------------|---------------------|-------|
| 295/80R22.5 | 3.0 mm | 8-9 mm | R3 |
| 315/70R22.5 | 3.0 mm | 8-9 mm | R3 |
| 315/80R22.5 | 3.0 mm | 8-9 mm | R3 |
| 385/55R22.5 | 3.0 mm | 8-9 mm | R3 |
| 385/65R22.5 | 3.0 mm | 8-9 mm | R3 |

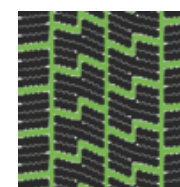

NOKIAN TYRES HAKKAPELIITTA TRUCK D

| Tire size | Regrooving depth | Width of regrooving | Blade |
|-------------|------------------|---------------------|-------|
| 275/70R22.5 | 2.5 mm | 7-8 mm | R3 |
| 295/80R22.5 | 3.0 mm | 7-8 mm | R3 |
| 315/70R22.5 | 2.5 mm | 7-8 mm | R3 |
| 315/80R22.5 | 3.0 mm | 7-8 mm | R3 |

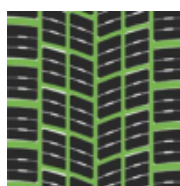

NOKIAN TYRES HAKKA TRUCK DRIVE

| Tire size | Regrooving depth | Width of regrooving | Blade |
|-------------|------------------|---------------------|-------|
| 295/60R22.5 | 2.5 mm | 7-8 mm | R3 |
| 315/60R22.5 | 2.5 mm | 7-8 mm | R3 |
| 295/80R22.5 | 3.0 mm | 7-8 mm | R3 |
| 315/70R22.5 | 3.0 mm | 7-8 mm | R3 |
| 315/80R22.5 | 3.0 mm | 7-8 mm | R3 |



NOKIAN TYRES HAKKA TRUCK COACH

| Tire size | Regrooving depth | Width of regrooving | Blade |
|-------------|------------------|---------------------|-------|
| 295/80R22.5 | 2.5 mm | 6-7 mm | R3 |
| 315/80R22.5 | 2.5 mm | 6-7 mm | R3 |

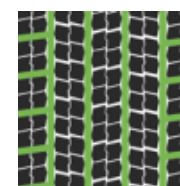

NOKIAN TYRES HAKKAPELIITTA CITY BUS

| Tire size | Regrooving depth | Width of regrooving | Blade |
|-------------|------------------|---------------------|-------|
| 275/70R22.5 | 3.0 mm | 6-7 mm | R3 |
| 295/80R22.5 | 2.5 mm | 6-7 mm | R3 |

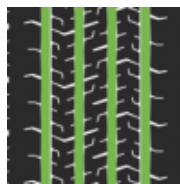

NOKIAN TYRES HAKKA TRUCK STEER

| Tire size | Regrooving depth | Width of regrooving | Blade |
|-------------|------------------|---------------------|-------|
| 315/60R22.5 | 3.0 mm | 8-9 mm | R3 |
| 295/80R22.5 | 3.0 mm | 8-9 mm | R3 |
| 315/70R22.5 | 3.0 mm | 8-9 mm | R3 |
| 315/80R22.5 | 3.0 mm | 8-9 mm | R3 |
| 385/55R22.5 | 3.0 mm | 8-9 mm | R3 |
| 385/65R22.5 | 3.0 mm | 8-9 mm | R3 |

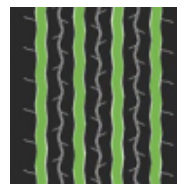

NOKIAN TYRES E-TRUCK TRAILER

| Tire size | Regrooving depth | Width of regrooving | Blade |
|-------------|------------------|---------------------|-------|
| 215/75R17.5 | 2.0 mm | 6-7 mm | R3 |
| 235/75R17.5 | 2.0 mm | 6-7 mm | R3 |
| 245/70R17.5 | 2.0 mm | 6-7 mm | R3 |
| 265/70R19.5 | 2.5 mm | 7-9 mm | R3 |
| 385/55R22.5 | 2.5 mm | 7-9 mm | R3 |
| 385/65R22.5 | 2.5 mm | 7-9 mm | R3 |

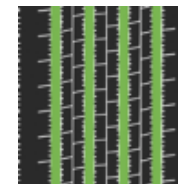

NOKIAN TYRES E-TRUCK STEER

| Tire size | Regrooving depth | Width of regrooving | Blade |
|-------------|------------------|---------------------|-------|
| 215/75R17.5 | 1.5 mm | 6-7 mm | R3 |
| 235/75R17.5 | 1.5 mm | 6-7 mm | R3 |
| 265/70R19.5 | 1.5 mm | 7-8 mm | R3 |
| 285/70R19.5 | 1.5 mm | 7-8 mm | R3 |
| 295/80R22.5 | 2.0 mm | 8-9 mm | R3 |
| 315/70R22.5 | 2.0 mm | 8-9 mm | R3 |
| 315/80R22.5 | 2.5 mm | 8-9 mm | R3 |
| 385/65R22.5 | 2.0 mm | 8-9 mm | R3 |
| 385/55R22.5 | 2.0 mm | 8-9 mm | R3 |

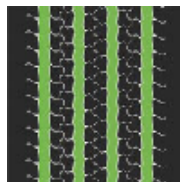

NOKIAN TYRES HAKKA TRUCK TRAILER

| Tire size | Regrooving depth | Width of regrooving | Blade |
|-------------|------------------|---------------------|-------|
| 265/70R19.5 | 2.5 mm | 7-8 mm | R3 |
| 275/70R22.5 | 3.0 mm | 8-9 mm | R3 |
| 385/65R22.5 | 2.5 mm | 8-9 mm | R3 |
| 385/55R22.5 | 2.0 mm | -9mm | R3 |

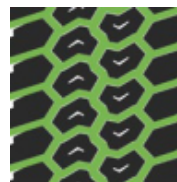

NOKIAN TYRES R-TRUCK TRAILER

| Tire size | Regrooving depth | Width of regrooving | Blade |
|-------------|------------------|---------------------|-------|
| 265/70R19.5 | 3.0 mm | 7-8 mm | R3 |
| 285/70R19.5 | 3.0 mm | 8-10 mm | R4 |
| 275/70R22.5 | 3.0 mm | 8-10 mm | R4 |
| 385/65R22.5 | 3.0 mm | 8-10 mm | R4 |

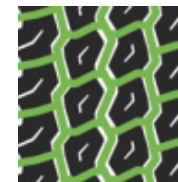

NOKIAN TYRES R-TRUCK STEER

| Tire size | Regrooving depth | Width of regrooving | Blade |
|-------------|------------------|---------------------|-------|
| 315/80R22.5 | 3.0 mm | 8-10 mm | R4 |
| 385/65R22.5 | 3.0 mm | 8-10 mm | R4 |

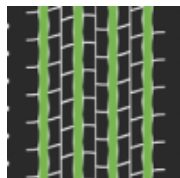

**NOKIAN TYRES HAKKA TRUCK 844/
844PLUS**

| Tire size | Regrooving depth | Width of regrooving | Blade |
|-------------|------------------|---------------------|-------|
| 265/70R19.5 | 2.5 mm | 7-8 mm | R3 |
| 275/70R22.5 | 3.0 mm | 8-9 mm | R3 |
| 385/55R22.5 | 3.0 mm | 8-9 mm | R3 |

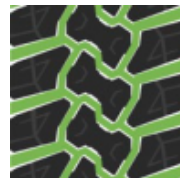

NOKIAN TYRES R-TRUCK DRIVE

| Tire size | Regrooving depth | Width of regrooving | Blade |
|-------------|------------------|---------------------|-------|
| 315/80R22.5 | 3.0 mm | 8-10 mm | R4 |



NOKIAN TYRES E-TRUCK DRIVE

| Tire size | Regrooving depth | Width of regrooving | Blade |
|-------------|------------------|---------------------|-------|
| 215/75R17.5 | 1.5 mm | 6-7 mm | R3 |
| 235/75R17.5 | 1.5 mm | 6-7 mm | R3 |
| 265/70R19.5 | 1.5 mm | 6-7 mm | R3 |
| 285/70R19.5 | 1.5 mm | 6-7 mm | R3 |
| 295/80R22.5 | 2.5 mm | 7-8 mm | R3 |
| 315/70R22.5 | 2.5 mm | 7-8 mm | R3 |
| 315/80R22.5 | 2.5 mm | 7-8 mm | R3 |

STUDDING OF NOKIAN TYRES HAKKAPELIITTA TRUCK BRANDED TIRES

Most of the Nokian Tyres Hakkapeliitta Truck branded tires have pre-marked stud places where the studs can be installed following the below instructions.

- Recommended stud for truck tires has a length of 15 mm and flange diameter of 11 mm. Recommended drilling diameter is 5 mm and drilling depth is 13 mm.
- It should be noted that there are national regulations about the maximum stud weight, which must be followed. For example, in Finland, the maximum stud weight for heavy vehicles (over 3,5 ton) is 5 g.

STUDDING PLAN BY TREAD DESIGN AND TIRE SIZE

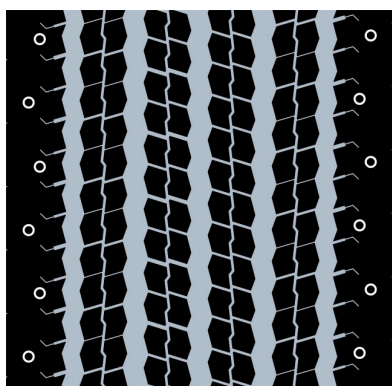

HAKKAPELIITTA TRUCK F2

| Tire size | Number of studs |
|-------------|-----------------|
| 295/80R22.5 | 158 |
| 315/70R22.5 | 152 |
| 315/80R22.5 | 160 |
| 385/55R22.5 | 136 |
| 385/65R22.5 | 142 |

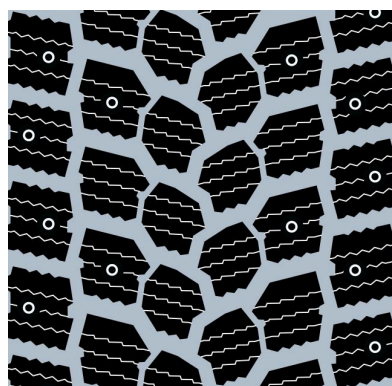

HAKKAPELIITTA TRUCK E2

| Tire size | Number of studs |
|-------------|-----------------|
| 275/70R22.5 | 150 |
| 295/80R22.5 | 168 |
| 315/70R22.5 | 162 |
| 315/80R22.5 | 174 |

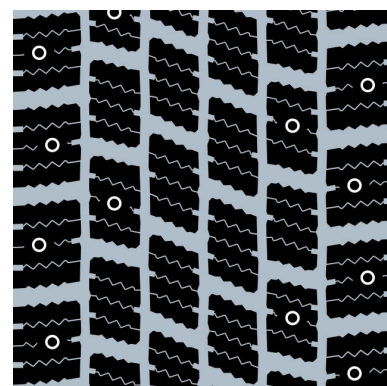

HAKKAPELIITTA TRUCK D

| Tire size | Number of studs |
|-------------|-----------------|
| 275/70R22.5 | 146 |

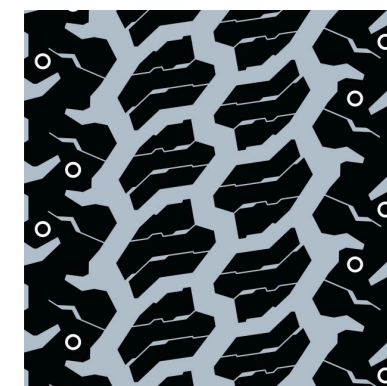

HAKKAPELIITTA TRUCK T

| Tire size | Number of studs |
|-------------|-----------------|
| 265/70R19.5 | 114 |





AREAS OF USE AND EU LABEL INFO

EU TIRE LABELS FOR EASY COMPARISON

From May 1st 2021, also truck and bus tires must carry the EU tire label. The labels show important tire properties such as grip, fuel efficiency and noise level at a glance, making it easy to choose a safer, more eco-friendly tire.

You can find the EU label information on each Nokian Tyres product page by clicking on “Show more” under the size information. [NOKIANTYRES.COM/HEAVY/EU-LABELS](https://www.nokiantyres.com/heavy/eu-labels)

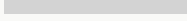
| | Winter use | Long distance | Regional | Light & medium trucks | Timber transport | On/Off road | Long distance buses | City buses | 3PMSF M+S markings |
|--------------------------|---|---|---|--|---|---|---|---|--------------------|
| |  |  |  |  |  |  |  |  | |
| Steer | | | | | | | | | |
| Hakkapeliitta Truck F2 | ** | ██████████ | | | ██████████ | ██████████ | ██████████ | ██████████ | 3PMSF, M+S |
| Hakka Truck Coach | ** | ██████████ | | | | | ██████████ | | 3PMSF, M+S |
| Hakkapeliitta City Bus | ** | | | | | | | ██████████ | 3PMSF, M+S |
| Hakka Truck Steer | * | ██████████ | | | | | ██████████ | ██████████ | 3PMSF, M+S |
| Hakka Truck 844PLUS | * | | ██████████ | | | | | ██████████ | 3PMSF, M+S |
| E-Truck Steer | * | ██████████ | | | | | ██████████ | ██████████ | 3PMSF, M+S |
| E-Truck Steer 17.5" | * | | | ██████████ | | | | ██████████ | 3PMSF, M+S |
| E-Truck Steer 19.5" | * | | ██████████ | ██████████ | | | | | 3PMSF, M+S |
| R-Truck Steer | * | | | | ██████████ | ██████████ | | | 3PMSF, M+S |
| Drive | | | | | | | | | |
| Hakkapeliitta Truck D | ** | ██████████ | ██████████ | | | | ██████████ | ██████████ | 3PMSF, M+S |
| Hakkapeliitta Truck E/E2 | ** | ██████████ | ██████████ | | ██████████ | ██████████ | ██████████ | ██████████ | 3PMSF, M+S |
| Hakka Truck Coach | ** | ██████████ | | | | | ██████████ | | 3PMSF, M+S |

| | Winter use  | Long distance  | Regional  | Light & medium trucks  | Timber transport  | On/Off road  | Long distance buses  | City buses  | 3PMSF M+S markings | |
|------------------------|---|--|---|---|---|--|--|---|---|------------|
| Hakkapeliitta City Bus | ** | | | | | | |  | 3PMSF, M+S | |
| Hakka Truck Drive | ** |  |  | | | | |  |  | 3PMSF, M+S |
| Hakkapeliitta Truck T | ** | |  | | | | | | | 3PMSF, M+S |
| E-Truck Drive | * |  | | | | | |  |  | 3PMSF, M+S |
| E-Truck Drive 17.5" | * | | |  | | | | | | 3PMSF, M+S |
| E-Truck Drive 19.5" | * | |  |  | | | | | | 3PMSF, M+S |
| R-Truck Drive | * | | | |  |  | | | | 3PMSF, M+S |
| Trailer | | | | | | | | | | |
| Hakkapeliitta Truck F2 | ** |  | | | | | | | | 3PMSF, M+S |
| Hakkapeliitta Truck T | ** |  |  | |  | | | | | 3PMSF, M+S |
| Hakka Truck Trailer | ** |  | | | | | | | | 3PMSF, M+S |
| Hakka Truck 844PLUS | * |  |  | | | | | | | 3PMSF, M+S |
| Hakka Truck 844 | * |  |  | | | | | | | 3PMSF, M+S |
| E-Truck Trailer | * |  | | | | | | | | 3PMSF, M+S |
| R-Truck Trailer | * |  |  | |  | | | | | 3PMSF, M+S |

** Excellent grip in severe winter conditions

* Good grip in normal winter road conditions

HOW TO USE LOAD CAPACITY TABLES?

Q: HOW TO FIND THE RIGHT INFLATION PRESSURE?

Tire: 650/65R26.5 174 D ELS

Load per tire: 7 000 kg / 15 432 lb

Max speed of vehicle: 40 km/h / 25 mph

A: Correct inflation pressure is 2.8 bar / 41 psi

SIZE 650/65R26.5 174 D

| Constant | | 0.8 bar | 12 psi | 1.2 bar | 17 psi | 1.6 bar | 23 psi | 2.0 bar | 29 psi | 2.4 bar | 35 psi | 2.8 bar | 41 psi | 3.2 bar | 46 psi | 3.6 bar | 53 psi | 4.0 bar | 58 psi |
|----------|------|---------|--------|---------|--------|---------|--------|---------|--------|---------|--------|---------|--------|---------|--------|---------|--------|---------|--------|
| km/h | mph | kg | lbs | kg | lbs | kg | lbs | kg | lbs | kg | lbs | kg | lbs | kg | lbs | kg | lbs | kg | lbs |
| 10 | 5 | 4 260 | 9 390 | 5 400 | 11 905 | 6 400 | 14 110 | 7 200 | 15 875 | 8 350 | 18 410 | 9 300 | 20 505 | 10 100 | 22 265 | 11 100 | 24 470 | 12 100 | 26 675 |
| 20 | 12.5 | 3 900 | 8 600 | 4 960 | 10 935 | 5 860 | 12 920 | 6 600 | 14 550 | 7 650 | 16 865 | 8 500 | 18 740 | 9 250 | 20 395 | 10 150 | 22 375 | 11 100 | 24 470 |
| 25 | 15 | 3 740 | 8 245 | 4 740 | 10 450 | 5 620 | 12 390 | 6 350 | 14 000 | 7 350 | 16 205 | 8 150 | 17 965 | 8 850 | 19 510 | 9 750 | 21 495 | 10 600 | 23 370 |
| 30 | 20 | 3 580 | 7 890 | 4 540 | 10 010 | 5 380 | 11 860 | 6 050 | 13 340 | 7 000 | 15 430 | 7 800 | 17 195 | 8 500 | 18 740 | 9 300 | 20 505 | 10 150 | 22 375 |
| 40 | 25 | 3 220 | 7 100 | 4 080 | 8 995 | 4 840 | 10 670 | 5 440 | 11 995 | 6 300 | 13 870 | 7 050 | 15 540 | 7 650 | 16 865 | 8 400 | 18 520 | 9 150 | 20 170 |
| 50 | 30 | 2 860 | 6 305 | 3 640 | 8 025 | 4 300 | 9 480 | 4 840 | 10 670 | 5 600 | 12 345 | 6 250 | 13 780 | 6 800 | 14 990 | 7 450 | 16 425 | 8 150 | 17 965 |
| 65 | 40 | 2 360 | 5 205 | 3 000 | 6 615 | 3 550 | 7 825 | 4 000 | 8 820 | 4 625 | 10 195 | 5 150 | 11 355 | 5 600 | 12 345 | 6 150 | 13 560 | 6 700 | 14 770 |

Q: HOW TO FIND A MAXIMUM SPEED FOR THE APPLICATION (HIGHEST SPEED WITH THE CHOSEN TIRE)?

Tire: 650/60R34 175 D

Load per tire: 10 000 kg / 22 046 lb

Inflation pressure: 4.0 bar / 58 psi. Use tire maximum inflation pressure to gain the highest speed value

A: Maximum speed is 30 km/h / 20 mph

SIZE 650/60R34 175 D

| Constant | | 0.8 bar | 12 psi | 1.2 bar | 17 psi | 1.6 bar | 23 psi | 2.0 bar | 29 psi | 2.4 bar | 35 psi | 2.8 bar | 41 psi | 3.2 bar | 46 psi | 3.6 bar | 53 psi | 4.0 bar | 58 psi |
|----------|------|---------|--------|---------|--------|---------|--------|---------|--------|---------|--------|---------|--------|---------|--------|---------|--------|---------|--------|
| km/h | mph | kg | lbs | kg | lbs | kg | lbs | kg | lbs | kg | lbs | kg | lbs | kg | lbs | kg | lbs | kg | lbs |
| 10 | 5 | 4 500 | 9 920 | 5 540 | 12 215 | 6 750 | 14 880 | 7 650 | 16 865 | 8 550 | 18 850 | 9 850 | 21 715 | 10 450 | 23 040 | 11 350 | 25 020 | 12 450 | 27 445 |
| 20 | 12.5 | 4 140 | 9 125 | 5 080 | 11 200 | 6 200 | 13 670 | 7 050 | 15 540 | 7 850 | 17 305 | 9 000 | 19 840 | 9 600 | 21 165 | 10 400 | 22 930 | 11 400 | 25 130 |
| 25 | 15 | 3 960 | 8 730 | 4 860 | 10 715 | 5 940 | 13 095 | 6 750 | 14 880 | 7 550 | 16 645 | 8 650 | 19 070 | 9 200 | 20 280 | 10 000 | 22 045 | 10 950 | 24 140 |
| 30 | 20 | 3 780 | 8 335 | 4 660 | 10 275 | 5 680 | 12 520 | 6 450 | 14 220 | 7 200 | 15 875 | 8 250 | 18 190 | 8 800 | 19 400 | 9 550 | 21 055 | 10 450 | 23 040 |
| 40 | 25 | 3 400 | 7 495 | 4 200 | 9 260 | 5 100 | 11 245 | 5 780 | 12 745 | 6 500 | 14 330 | 7 450 | 16 425 | 7 900 | 17 415 | 8 600 | 18 960 | 9 400 | 20 725 |
| 50 | 30 | 3 040 | 6 700 | 3 740 | 8 245 | 4 540 | 10 010 | 5 160 | 11 375 | 5 760 | 12 700 | 6 600 | 14 550 | 7 050 | 15 540 | 7 650 | 16 865 | 8 350 | 18 410 |
| 65 | 40 | 2 500 | 5 510 | 3 075 | 6 780 | 3 750 | 8 265 | 4 250 | 9 370 | 4 750 | 10 470 | 5 450 | 12 015 | 5 800 | 12 785 | 6 300 | 13 890 | 6 900 | 15 210 |

Notice!

Exceeding maximum speed leads to tire overheating resulting in premature break-up.

Q: FOR THE TIRE, WHAT ARE THE REQUIRED (MINIMUM) INFLATION PRESSURES WHEN:

- 1) Driving on the road?
- 2) Working on the field?

Tire: 710/55R34 177 D

Load per tire: 7 000 kg / 15 432 lb

A:

- 1) Vehicle keeps maximum speed in 50 km/h / 30 mph.

With this load the minimum inflation pressure is 2.8 bar/41 psi.

- 2) Maximum speed in field applications is 10 km/h / 5 mph.

With this load the minimum inflation pressure is 1.6 bar / 23 psi.

SIZE 710/55R34 177 D

| | Constant | 0.8 bar | 12 psi | 1.2 bar | 17 psi | 1.6 bar | 23 psi | 2.0 bar | 29 psi | 2.4 bar | 35 psi | 2.8 bar | 41 psi | 3.2 bar | 46 psi | 3.6 bar | 53 psi | 4.0 bar | 58 psi | |
|--------------|----------|---------|--------|---------|--------|---------|--------|---------|--------|---------|--------|---------|--------|---------|--------|---------|--------|---------|--------|--------|
| | km/h | mph | kg | lbs | kg | lbs | kg | lbs | kg | lbs | kg | lbs | kg | lbs | kg | lbs | kg | lbs | kg | lbs |
| Field | 10 | 5 | 4 780 | 10 540 | 5 860 | 12 920 | 7 200 | 15 875 | 8 100 | 17 855 | 9 300 | 20 505 | 10 450 | 23 040 | 11 100 | 24 470 | 12 100 | 26 675 | 13 150 | 28 990 |
| | 20 | 12.5 | 4 380 | 9 655 | 5 380 | 11 860 | 6 600 | 14 550 | 7 450 | 16 425 | 8 500 | 18 740 | 9 600 | 21 165 | 10 150 | 22 375 | 11 100 | 24 470 | 12 050 | 26 565 |
| | 25 | 15 | 4 200 | 9 260 | 5 140 | 11 330 | 6 350 | 14 000 | 7 150 | 15 765 | 8 150 | 17 965 | 9 200 | 20 280 | 9 750 | 21 495 | 10 600 | 23 370 | 11 550 | 25 465 |
| | 30 | 20 | 4 020 | 8 860 | 4 920 | 10 845 | 6 050 | 13 340 | 6 800 | 14 990 | 7 800 | 17 195 | 8 800 | 19 400 | 9 300 | 20 505 | 10 150 | 22 375 | 11 050 | 24 360 |
| | 40 | 25 | 3 620 | 7 980 | 4 420 | 9 745 | 5 440 | 11 995 | 6 150 | 13 560 | 7 050 | 15 540 | 7 900 | 17 415 | 8 400 | 18 520 | 9 150 | 20 170 | 9 950 | 21 935 |
| Road | 50 | 30 | 3 220 | 7 100 | 3 940 | 8 685 | 4 840 | 10 670 | 5 460 | 12 035 | 6 250 | 13 780 | 7 050 | 15 540 | 7 450 | 16 425 | 8 150 | 17 965 | 8 850 | 19 510 |
| | 65 | 40 | 2 650 | 5 840 | 3 250 | 7 165 | 4 000 | 8 820 | 4 500 | 9 920 | 5 150 | 11 355 | 5 800 | 12 785 | 6 150 | 13 560 | 6 700 | 14 770 | 7 300 | 16 095 |

LIMITED WARRANTY

READ OUR WARRANTIES ONLINE

Nokian Heavy Tyres limited warranty

Intuitu™ Sensor limited warranty

Extended warranty for users of the Intuitu mobile application

Go to nokiantyres.com/warrantyinfomation/ or click on the link in the Intuitu app.

Nokian Heavy Tyres' liability shall be limited to the aforesaid limited warranties and shall only be valid as stipulated in the limited warranties.

GENERAL TERMS OF DELIVERY

1. DEFINITIONS

1.1. The following definitions shall apply to these General Terms of Delivery and to any Agreement:

“Agreement” shall mean a signed document (including its appendices) referring to these General Terms of Delivery or to which these General Terms of Delivery are attached or any other agreement between the Parties concluded as stipulated in section 2.2.

“Buyer” shall mean a Party purchasing the Products.

“Force Majeure Event” shall mean events beyond the control of a Party which occur after the Agreement entered into force and which were not reasonably foreseeable at the time the Agreement entered into force and whose effects are not capable of being overcome without unreasonable expense and/or loss of time to the Party concerned. Events of Force Majeure will include (without being limited to) epidemic, pandemic, war, civil unrest, strikes, lockouts and other general labour disputes, acts of government, natural disasters, exceptional weather conditions, breakdown or general unavailability of transport facilities, accidents, fire, flood, explosions and general shortages of

energy.

“Intellectual Property Rights” shall mean patents (including petty patents and utility models), design patents, and designs (whether or not capable of registration), copyright, trademark, service mark, and any other form of statutory or common law intellectual property protection of any kind; and applications for any of the foregoing including without limitation reissues, divisions, or other continuations thereof, in all jurisdictions, where applicable.

“Party” shall mean either Nokian Tyres or the Buyer.

“Products” shall mean tires, tire sensors, studs and anti-slip devices, or other products developed and manufactured by or for Nokian Tyres. The Products shall be those specified in the Agreement or those agreed between the Parties from time to time.

“Nokian Tyres” shall mean Nokian Tyres plc and any of its affiliate companies.

“Restricted Person” shall mean a person, organization or entity that is:

(i) listed on a sanctions list, including but not limited to “Specifically Designated Nationals and Blocked Persons” maintained by OFAC in U.S., “Consolidated List of Financial Sanctions Targets in the UK” maintained by HMT in UK; (ii) located or resident in or incorporated under the laws of a country or territory that is, or whose government is, the target of a country-wide or territory-wide Trade Restriction; (iii) owned or controlled by a Restricted Person; or (iv) otherwise a target of a Trade Restriction.

“Trade Restrictions” shall mean export and import laws, orders, and licenses, embargoes, sanctions of an economic, commercial or financial nature, regulations on sectors subject to restrictions (such as use for military purposes), regulations concerning Restricted Persons and other restrictive measures of similar nature, as existing, amended, supplemented and substituted from time to time, administrated, enacted or enforced by United Nations, United States of America (including OFAC), European Union or any of its member states, countries of European Economic Area, United Kingdom (including HTM), any other competent jurisdiction or any competent authority of the above. Trade Restrictions also include any other restrictions that may have any direct or indirect impact of any nature on Nokian Tyres or its subsidiaries irrespective of the

country/government/ authority by which the Trade Restriction is administered, enacted or enforced.

2. ENTRY INTO FORCE OF AGREEMENT

2.1. The Agreement enters into force when signed by both Parties.

2.2. The Agreement enters also into force when the Buyer accepts in writing Nokian Tyres's tender regarding the delivery of the Products or when Nokian Tyres accepts the Buyer's purchase order regarding the delivery of the Products in writing or by delivering the Products specified in such purchase order.

2.3. No Buyer's terms in Buyer's request for tender, purchase order or any other document will form part of the Agreement unless specifically approved in writing by Nokian Tyres. The Buyer expressly waives any right to rely on such terms.

3. PRODUCTS AND SERVICES

3.1. Nokian Tyres reserves the right to apply quantity limits on any purchase order, to reject all or part of a purchase order, and to discontinue or make changes to Products without notice, even if Buyer has already placed a purchase order. Also,

even if a purchase order has been accepted, Nokian Tyres may subsequently cancel such purchase order in whole or in part due to product unavailability (including without limitation, any discontinuation of the Product).

3.2. Nokian Tyres may offer ancillary services related to the Products such as mobile applications for tire monitoring. Services are subject to separate terms and conditions with which Buyer undertakes to comply when using the services.

4. DELIVERY

4.1. The delivery term of the Products shall be FCA, premises named by Nokian Tyres (Incoterms 2020), unless otherwise agreed by the Parties.

4.2. The Buyer shall inspect the Products after the delivery. The delivery shall be deemed accepted if the Buyer has not presented Nokian Tyres with a written remark regarding the delivery of the Products within seven (7) days from the delivery date.

4.3. Nokian Tyres shall deliver the Products at the agreed time of delivery. If the time of delivery has not been agreed in writing, Nokian Tyres shall deliver the Products within a reasonable time from the entry into force of the Agreement provided that the Products are available or, if the Products are not available, within a reasonable

time after they become available. Even though Nokian Tyres agrees to take all commercially reasonable measures to meet the agreed delivery dates, the Buyer acknowledges and agrees that Nokian Tyres shall not be liable for its failure to meet the agreed delivery dates.

4.4. If Nokian Tyres has outstanding due receivables from the Buyer, Nokian Tyres has the right to refrain from delivering the Products until the Buyer has settled the due payments in full. In such an event, the agreed delivery time will be extended correspondingly.

4.5. Nokian Tyres shall be entitled to make also partial deliveries.

5. PRICE AND TERMS OF PAYMENT

5.1. The prices of the Products have been agreed in the Agreement. Unless otherwise agreed in writing, Nokian Tyres' price list in force at the time of entry into force of the Agreement shall be applied. Nokian Tyres can issue changes to applicable price lists with a prior notice of one (1) month. Prices do not include any value added or similar taxes, which shall be added to all prices according to the laws and regulations in force at the time of the delivery. All Products shall be invoiced and payments made in Euro currency (EUR).

5.2. When the amount of or basis for taxes or other public payments changes before the delivery of the Products, either due to regulation change or change in the practice, Nokian Tyres has the right to adjust the prices of the Products correspondingly.

5.3. Unless otherwise stipulated by Nokian Tyres in writing, any offer issued by Nokian Tyres to the Buyer is valid for three (3) months from the date of issuance of the offer.

5.4. Unless otherwise agreed in writing, the Products will be invoiced after the date of delivery. Payment shall be due within thirty (30) days of the date of the invoice. The Buyer is obliged to pay eleven and a half (11.5) percent of annual interest on overdue payments beginning from the due date.

5.5. If Nokian Tyres has agreed to grant credit to the Buyer for the payment of the Products, Buyer is upon Nokian Tyres' request obliged to provide Nokian Tyres all necessary financial information (including but not limited to financial statements of the company) that is needed to grant the credit and assess the creditworthiness of the Buyer during the credit period. The obligation to provide financial information to Nokian Tyres continues as long as there is any open credit i.e. unpaid receivables from Buyer. For sake of clarity, the granting of any credit is at the sole discretion of Nokian Tyres and subject to a separate

decision made by Nokian Tyres.

6. TRANSFER OF RISK AND TITLE

6.1. Products delivered shall remain, to the extent permitted by applicable law, the property of Nokian Tyres until the Buyer has paid the price of the Products and the value added or similar taxes related to the respective Products. The Buyer shall give Nokian Tyres all necessary assistance in taking any measures to protect Nokian Tyres' title to the Products.

6.2. Until the title to the Products passes to the Buyer in accordance with Section 5.1 above, the Buyer shall store the Products at no costs to Nokian Tyres separately from all other products in its possession and mark the Products so that they are clearly identified as Nokian Tyres' property.

6.3. Notwithstanding the fact that the Products remain the property of Nokian Tyres, the Buyer may sell or use the Products in the ordinary course of the Buyer's business at full market value for the account of Nokian Tyres. Any such sale or use shall be a sale or use of Nokian Tyres' property by the Buyer and the Buyer shall act as the principal when making such sales or dealings. Until the title to the Products passes from Nokian Tyres to the Buyer, the entire proceeds from the sale or other dealings of the Products shall be

held in trust for Nokian Tyres and shall not be mixed with other money or paid into any overdrawn bank account of the Buyer and shall be at all times identified as Nokian Tyres' money. Also, until the title to the Products passes from Nokian Tyres to the Buyer, the Buyer shall assign its outstanding claims arising from the resale of the Products to Nokian Tyres as a security for Nokian Tyres' claims.

6.4. Until the title to the Products passes from Nokian Tyres to the Buyer, the Buyer shall upon Nokian Tyres' request return the delivered and unsold Products to Nokian Tyres. If the Buyer fails to do so, Nokian Tyres may enter upon any premises owned or occupied or controlled by the Buyer where the Products are supposed to be situated and repossess the Products. Upon such repossession, the rights of the Buyer under the Agreement with respect to the Products in question shall terminate.

6.5. The Buyer shall not pledge any of the Products which are still owned by Nokian Tyres. Without prejudice to any other rights of Nokian Tyres, if the Buyer does so, all sums whatsoever owed by the Buyer to Nokian Tyres shall become immediately due and payable.

6.6. The Buyer shall insure and keep insured the Products to their full market value against all risks to the reasonable satisfaction of Nokian Tyres until the date when the title to the Products

passes from Nokian Tyres to the Buyer, and shall whenever requested by Nokian Tyres produce a copy of the respective insurance policy. Without prejudice to the other rights of Nokian Tyres, if the Buyer fails to do so, all sums whatsoever owed by the Buyer to Nokian Tyres shall become immediately due and payable.

6.7. Notwithstanding the fact that the title to the Products shall remain with Nokian Tyres in accordance with the above provisions, the risk of damage or loss of the Products shall pass to the Buyer at the following times: (a) in the case the Products are to be delivered at Nokian Tyres's premises, at the time when Nokian Tyres notifies the Buyer that the Products are available for collection; or (b) in the case the Products are to be delivered otherwise than at Nokian Tyres's premises, at the time determined in the applicable delivery term.

7. WARRANTIES

7.1. Nokian Tyres' warranty terms concerning the Products are set out in Nokian Heavy Tyres' limited warranty terms valid at the time of the delivery. EXCEPT AS SET FORTH IN SUCH WARRANTY TERMS, THERE ARE NO OTHER EXPRESS OR IMPLIED WARRANTIES, INCLUDING BUT NOT LIMITED TO ANY IMPLIED WARRANTIES OF MERCHANTABILITY OR FITNESS FOR A PARTICULAR PURPOSE. To the maximum extent permitted by the applicable law, Nokian Tyres

shall have no other obligations or liabilities with respect to any possible defect or deficiency in the Products delivered hereunder than as set forth in the above- mentioned warranty terms.

8. LIABILITY AND CLAIMS

8.1. To the extent permitted by the applicable law, under no circumstances shall Nokian Tyres' liability under this Agreement exceed the invoice price of any Products with respect to which a claim is made.

8.2. Under no circumstances shall Nokian Tyres be liable under this Agreement for any indirect or consequential damage or loss, including without limitation any increased costs or expenses, or loss of profit, business, contracts, revenues or anticipated savings.

8.3. When Nokian Tyres has expressly agreed with the Buyer on the return of any of the delivered Products to Nokian Tyres, the Buyer assumes full responsibility for ensuring that the Products are placed in Nokian Tyres' possession. Nokian Tyres shall not accept any liability for any loss of any Products in transit.

8.4. The Buyer acknowledges and agrees to that any data generated by Nokian Tyres' digital services regarding the use of Products can be used in processing of claims made by the Buyer towards Nokian Tyres.

9. SPECIFICATIONS AND INTELLECTUAL PROPERTY RIGHTS

9.1. The weights, dimensions, capacities, prices, performance ratings and other data included in catalogues, prospectuses, circulars, advertisements and price lists and other similar information regarding the Products, as expressed in Nokian Tyres' general product information, constitute an approximate guide. This data shall not be binding on Nokian Tyres, save to the extent that it is by reference expressly included in the Agreement.

9.2. No right or license is granted under the Agreement to the Buyer under any patent, trademark, copyright, registered design or other Intellectual Property Rights, except for the right to use or resell the Products.

9.3. All Products sold in retail packaging may be resold by the Buyer only in the packaging supplied by Nokian Tyres and in no case may any trademark other than those applied by Nokian Tyres be marked on or applied in relation to the Products.

10. CONFIDENTIALITY

10.1. The Buyer undertakes to keep confidential all terms and conditions of the Agreement and its appendices, as well as all information given on

Nokian Tyres' or its business partners' operations, products and services and any information regarded as trade secrets of Nokian Tyres. The Buyer shall not (and shall secure that its directors, agents and employees shall not) be entitled at any time without prior written consent of Nokian Tyres to disclose Nokian Tyres' confidential information to any third party or to use it whether directly or indirectly for other purposes than in accordance with the Agreement. The obligation of confidentiality shall survive the termination of the Agreement and remain in force for five (5) years thereafter.

10.2. The Section 10.1 shall not apply to any information which (i) the receiving Party can prove to have been in its possession at the date of receipt or (ii) which is or becomes public knowledge otherwise than through a breach of an obligation of confidentiality.

11. INTEGRITY AND CODE OF CONDUCT

11.1. The Nokian Tyres' Code of Conduct applies to the business relationship between the parties (available at Nokian Tyres' webpages). The Buyer agrees to comply with the principles set out therein, as amended from time to time. 11.2. The Buyer further warrants that the Buyer or any individuals or entities acting for or on behalf of the Buyer have not violated any applicable laws and regulations related to anti-trust and

competition, anti-corruption or money laundering and warrants that applicable anti-trust and competition, anti-corruption or money laundering laws and regulations are complied with in all its activities.

12. DATA PRIVACY

12.1. As a part of the cooperation under the Agreement, Nokian Tyres may collect and processes personal data about the representatives of the Buyer. Nokian Tyres processes the personal data in accordance with applicable data protection legislation. More information about for what purposes and how personal data is collected and processed by Nokian Tyres is available in Nokian Tyres' Privacy Statement, which is available at <https://www.nokiantyres.com/privacy-statement/>.

12.2. Unless otherwise agreed, the cooperation under the Agreement does not include any processing of personal data by one party on behalf of the other party, or any sharing or disclosure of personal data, and the parties agree that each party is independently responsible for complying with applicable data protection legislation with regard to the personal data they may process.

12.3. If the cooperation under the Agreement would include disclosing personal data from one party to another, but no party processes personal

data on behalf of the other party, the original controller of the personal data shall be responsible for ensuring that there is a legal basis for such disclosure.

13. TRADE RESTRICTIONS AND IMPORT/EXPORT CONTROLS

13.1. The Buyer warrants that it will comply in all respects with any Trade Restrictions for every Product delivered to the Buyer. The Buyer also assures that other individuals or entities acting for or on behalf of the Buyer comply with the Trade Restrictions.

13.2. The Buyer warrants that neither it nor any other Buyer belonging to same group of companies, nor any owner, beneficial owner, member of their board of directors nor any of their managing director nor any other director, employee, agent or representative or of any member of the group is currently a Restricted Person or have ever been a Restricted Person. The Buyer undertakes to inform Nokian Tyres without delay if any person or Buyer mentioned above shall become subject to a Trade Restriction.

13.3. Accordingly, the Buyer undertakes:

a) to obtain, at its own expense, any licenses, shipping documents and authorizations or

approvals to export or import the Products as may be required; and

b) not to advertise, market, promote, sell, lease or otherwise transfer the purchased Products to Restricted Person or to restricted countries/areas subject to Trade Restriction; and

c) not to advertise, market, promote, sell, lease or otherwise transfer the purchased Products for the purpose of using them in restricted sectors, insofar as the transfer is restricted according to a Trade Restriction and insofar as a license or approval has not been obtained; and

d) to comply with any applicable Trade Restrictions with regard to issuance of payments and finance associated with the Products.

13.4. The Buyer shall indemnify Nokian Tyres and hold Nokian Tyres harmless from and against any damages, liabilities or costs resulting from the Buyer's violation or alleged violation of the Trade Restrictions.

13.5. Nokian Tyres retains the right to cancel or delay delivery of any Product at any time without penalty or liability of any nature, as, at the sole discretion of Nokian Tyres, required with respect to a Trade Restrictions. The delivery may be delayed until a license, approval or similar is granted or for the duration of the restriction. If

purchased Products are transferred in violation of the Trade Restrictions, Nokian Tyres shall not be obligated to provide any warranty for the Products transferred.

13.6. Nokian Tyres is, at their sole discretion, also entitled to terminate the Agreement with immediate effect without penalty or liability of any nature if a delivery of any Product or any other performance of either Party under the Agreement may result in violation of any Trade Restriction.

13.7. Nokian Tyres shall be entitled to audit the Buyer's compliance with obligations relating to these matters. The Buyer shall supply on request all necessary information to verify compliance.

13.8. As a customer of Nokian Tyres, the Buyer may have been required to provide certain information of the Buyer to Nokian Tyres in accordance with Nokian Tyres' client onboarding process before the signing of this Agreement. The Buyer undertakes to inform Nokian Tyres immediately if there are any changes to the information provided as part of Nokian Tyres' customer onboarding process.

14. TERM AND TERMINATION

14.1. The Agreement shall be in full force and effect (i) until Parties' obligations under the

Agreement have been fulfilled or (ii) in case of a continuous agreement until terminated by either party for any reason with at least three (3) months prior written notice. Termination of a continuous Agreement in accordance with this section 14.1 shall not relieve neither Party from any obligations related to orders accepted before termination.

14.2. The Agreement may be terminated with immediate effect by the non-defaulting Party with a written notice to the other Party in the event that (a) the other Party commits a material breach of the Agreement and fails to remedy such breach (if capable of being remedied) within thirty (30) days after having been notified thereof in writing; or (b) the other Party commits an act of bankruptcy, is placed in liquidation or becomes otherwise incapable of fulfilling its financial obligations under the Agreement, or should it become apparent that any of the above occurrences shall take place.

14.3. Furthermore, the Agreement may be terminated with immediate effect with a written notice by Nokian Tyres to the Buyer in the event that (a) there is a direct or indirect change of ownership or control or other substantial change in the management, staff or the business operations of the Buyer which may adversely affect achieving the purpose of the Agreement; (b) Buyer violates any of its obligations under sections 9, 10, 11, 12 or 13; or (c) the Buyer enters

into an agreement with a third party or engages itself in any activity which prejudices the confidentiality of Nokian Tyres' confidential material or information.

14.4. Upon termination of the Agreement due to the Buyer's breach, Nokian Tyres shall have the right to do one or more of the following: (a) revoke any express or implied authority to sell, resell, use or consume any Products whose title has not passed to the Buyer and re-sell such Products; (b) suspend any deliveries to be made under any agreement with the Buyer; and/or (c) make claim against the Buyer for the price of the unpaid Products and/ or damages.

15. OTHER TERMS

15.1. In case of conflict, the Agreement shall take precedence over these General Terms of Delivery, and these General Terms of Delivery shall take precedence over any other appendices of the Agreement.

15.2. The Agreement constitutes the entire agreement between the parties with respect to the subject matter and supersedes all other prior agreements and understandings, both written and oral, between the parties with respect to the subject matter.

15.3. Neither Party shall be liable to the other Party for any delay or non-performance of its

obligations under the Agreement in the event and to the extent that such delay or non-performance is due to an Force Majeure Event.

15.4. The Agreement and these General Terms of Delivery shall be construed and enforced in accordance with the laws of Finland, excluding its choice of law provisions and Convention on Contracts for the International Sale of Goods (CISG). Any dispute, controversy or claim arising out of or relating to the Agreement, or the breach, termination or validity thereof, shall be finally settled in arbitration by one (1) arbitrator in accordance with the Arbitration Rules of the Central Chamber of Commerce of Finland. The arbitration shall be conducted in Helsinki.