



TECHNICAL MANUAL

UPDATED: 2025-03-29

NOKIAN HEAVY TYRES

nokian[®]
TYRES

TABLE OF CONTENTS

GENERAL INFO	3	TIRE CHOICE AND INFLATION PRESSURES BY 40 APPLICATION	
TIRE MARKINGS	4	GROUND CONTACT PRESSURE COMPARISON	86
TIRE STRUCTURES	11	CONTACT AREAS ON A HARD DRIVING SURFACE	92
INFLATION PRESSURE	12	STUDS AND CHAINS	95
LIQUID AND SALT BALLASTING	14	MPT AGILE STUD RECOMMENDATIONS	99
TRACTOR AND LOADER TIRES FOR WINTER APPLICATION	15	MOUNTING TIRES ON FOUR WHEEL DRIVE TRACTORS	100
NON-SKID CHAINS	17	MINE TIRE MAINTENANCE	102
TRACKS	18	HAKKAPELIITTA LOADER INFLATION PRESSURE RECOMMENDATIONS FOR DIFFERENT WHEEL LOADERS	103
RIMS	19	GROUND KARE AND EXCAVATOR MOUNTING RECOMMENDATIONS	106
RIM MARKINGS	20	NOKIAN TYRES INTUITU™ SMART TIRES	108
WHEEL STUD HOLES AND COUNTERSINKS	21	REGROOVING OF NOKIAN TYRES TRUCK AND BUS TIRES	110
RIM CONTOURS	25	REGROOVING RECOMMENDATIONS	111
WHEEL MAIN DIMENSIONS	26	STUDDING OF NOKIAN TYRES	114
WHEEL PARTS / COMPONENTS	27	HAKKAPELIITTA TRUCK BRANDED TIRES	
FORESTRY RIMS	28	AREAS OF USE AND EU LABEL INFO	115
KNURLING	29	HOW TO USE LOAD CAPACITY TABLES	117
TUBELESS FORESTRY RIMS	30	LIMITED WARRANTY	119
INDUSTRIAL AND EM MULTI-PIECE WHEELS	31	GENERAL TERMS OF DELIVERY	120
FLAPS AND O-RINGS	33		
INSPECTIONS ON RIMS	36		
TIRE MOUNTING CLAMPS	37		
TUBES AND VALVES	39		

GENERAL INFO

Nokian Heavy Tyres is passionate in developing high quality solutions for the most extreme conditions found in forests, modern day farming, municipal contracting, transportation terminals and underground applications. In addition to tire and supplementary item information, this manual focuses on the special necessities and requirements in each product category. The forestry section, for example, has a detailed guide on the right tire and inflation pressure choice by application. This technical manual will be your tool in finding the right tire for your work, with a promise on carefree working hours.

TIRE MARKINGS

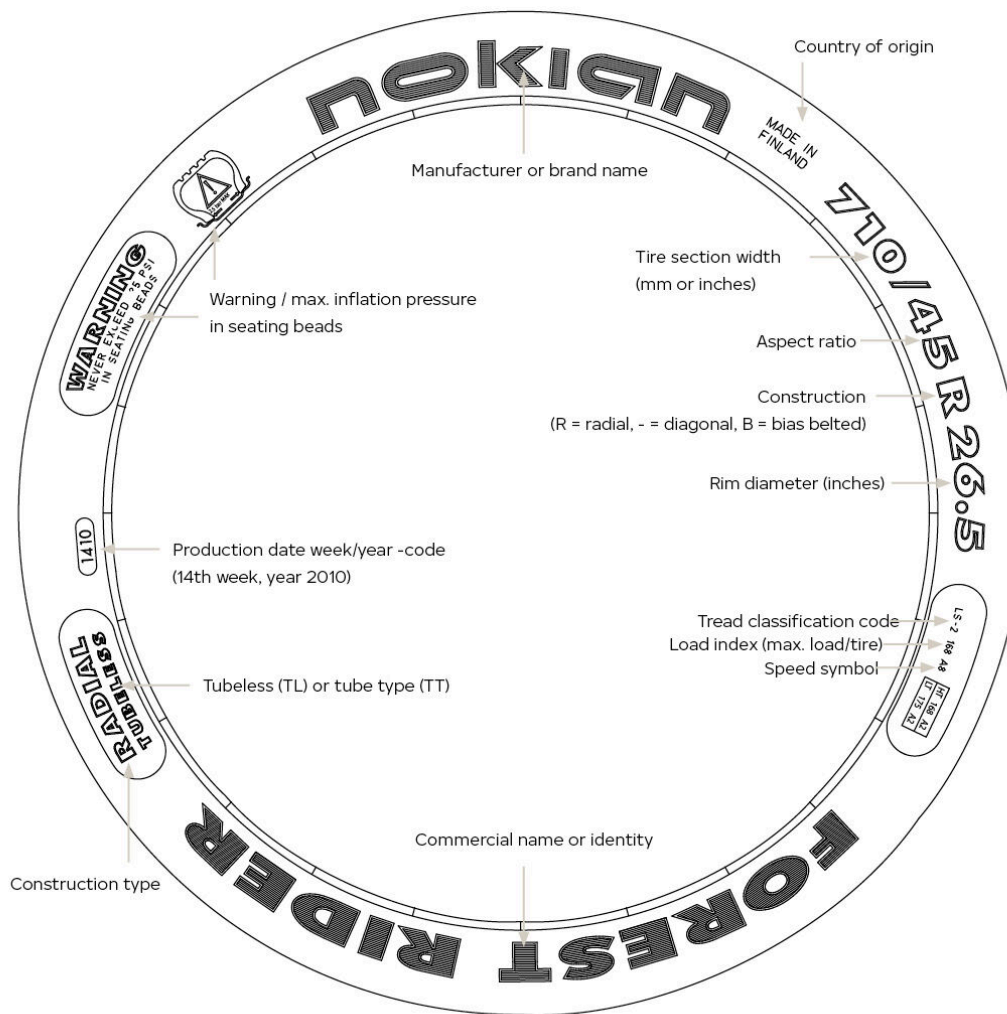

TIRE CLASSIFICATION CODES

OPTIONAL MARKING

TRA Code	Tread type
Agricultural tractor drive wheel tires	
R-1	Regular service (tread)
R-1W	Wet traction service
R-1S	Sprayer / spreader service
R-2	Cane and rice service (deep tread)
R-3	Flotation service (shallow tread)
R-4	Industrial service (construction application)
Agricultural tractor steering wheel tires (non-traction pattern)	
F-1	Single rib tread
F-2	Multiple rib tread
F-3	Industrial service (construction application)
Agricultural implement tires	
I-1	Multi-rib tread
I-2	Moderate traction service
I-3	Traction tread
I-4	Plough tail wheel service
I-5	Steering service
I-6	Smooth tread
Garden tractor tires (implement tires)	
G-1	Traction service
G-2	Flotation traction service
G-3	Maximum flotation service

TRA Code	Tread type
Grader tires (Motor graders)	
G-2	Traction regular
G-3	Rock regular
Logging and forestry service tires	
LS-1	Regular tread
LS-2	Intermediate tread
LS-3	Deep tread
LS-4	Shallow tread
High flotation tires for off-the-road service	
HF-1	Shallow tread
HF-2	Regular tread
HF-3	Deep tread
HF-4	Extra deep tread
Earthmover tires (Dump trucks and scrapers)	
E-1	Rib regular
E-2	Traction regular
E-3	Rock regular
E-4	Rock deep tread
E-7	Flotation
Loader and dozer tires (Front-end loaders and dozers)	
L-2	Traction regular
L-3	Rock regular
L-4	Rock deep tread

TRA Code	Tread type
L-5	Rock extra deep tread
L-4S	Smooth deep tread
L-5S	Smooth extra deep tread
Compactor tires	
C-1	Smooth
Industrial tires (Straddle carriers, transfer cranes, towing tractors, reach stackers and fork lifts)	
IND-3	Traction regular
IND-4	Deep tread
IND-5	Extra deep tread

Notice! TRA = Tire and Rim Association Inc.

LOAD INDEX

THE LOAD INDEX (LI) IS A NUMERICAL CODE ASSOCIATED WITH THE MAXIMUM LOAD A TIRE CAN CARRY.

LI	kg	LI	kg	LI	kg	LI	kg	LI	kg	LI	kg	LI	kg	LI	kg	LI	kg	LI	kg	LI	kg	LI	kg	LI	kg
0	45	22	85	44	160	66	300	88	560	110	1 060	132	2 000	154	3 750	176	7 100	198	13 200	220	25 000	242	47 500	264	90 000
1	46.2	23	87.5	45	165	67	307	89	580	111	1 090	133	2 060	155	3 875	177	7 300	199	13 600	221	25 750	243	48 750	265	92 500
2	47.5	24	90	46	170	68	315	90	600	112	1 120	134	2 120	156	4 000	178	7 500	200	14 000	222	26 500	244	50 000	266	95 000
3	48.7	25	92.5	47	175	69	325	91	615	113	1 150	135	2 180	157	4 125	179	7 750	201	14 500	223	27 250	245	51 500	267	97 500
4	50	26	95	48	180	70	335	92	630	114	1 180	136	2 240	158	4 250	180	8 000	202	15 000	224	28 000	246	53 000	268	100 000
5	51.5	27	97.5	49	185	71	345	93	650	115	1 215	137	2 300	159	4 375	181	8 250	203	15 500	225	29 000	247	54 500	269	103 000
6	53	28	100	50	190	72	355	94	670	116	1 250	138	2 360	160	4 500	182	8 500	204	16 000	226	30 000	248	56 000	270	106 000
7	54.5	29	193	51	195	73	365	95	690	117	1 285	139	2 430	161	4 625	183	8 750	205	16 500	227	30 750	249	58 000	271	109 000
8	56	30	106	52	200	74	375	96	710	118	1 320	140	2 500	162	4 750	184	9 000	206	17 000	228	31 500	250	60 000	272	112 000
9	58	31	109	53	206	75	387	97	730	119	1 360	141	2 575	163	4 875	185	9 250	207	17 500	229	32 500	251	61 500	273	115 000
10	60	32	112	54	212	76	400	98	750	120	1 400	142	2 650	164	5 000	186	9 500	208	18 000	230	33 500	252	63 000	274	118 000
11	61.5	33	115	55	218	77	412	99	775	121	1 450	143	2 725	165	5 150	187	9 750	209	18 500	231	34 500	253	65 000	275	121 000
12	63	34	118	56	224	78	425	100	800	122	1 500	144	2 800	166	5 300	188	10 000	210	19 000	232	35 500	254	67 000	276	125 000
13	65	35	121	57	230	79	437	101	825	123	1 550	145	2 900	167	5 450	189	10 300	211	19 500	233	36 500	255	69 000	277	128 500
14	67	36	125	58	236	80	450	102	850	124	1 600	146	3 000	168	5 600	190	10 600	212	20 000	234	37 500	256	71 000	278	132 000
15	69	37	128	59	243	81	462	103	875	125	1 650	147	3 075	169	5 800	191	10 900	213	20 600	235	38 750	257	73 000	279	136 000
16	71	38	132	60	250	82	475	104	900	126	1 700	148	3 150	170	6 000	192	11 200	214	21 200	236	40 000	258	75 000		
17	73	39	136	61	257	83	487	105	925	127	1 750	149	3 250	171	6 150	193	11 500	215	21 800	237	41 250	259	77 500		
18	75	40	140	62	265	84	500	106	950	128	1 800	150	3 350	172	6 300	194	11 800	216	22 400	238	42 500	260	80 000		
19	77.5	41	145	63	272	85	515	107	975	129	1 850	151	3 450	173	6 500	195	12 150	217	23 000	239	43 750	261	82 500		
20	80	42	150	64	280	86	530	108	1 000	130	1 900	152	3 550	174	6 700	196	12 500	218	23 600	240	45 000	262	85 000		
21	82.5	43	155	65	290	87	545	109	1 030	131	1 950	153	3 650	175	6 900	197	12 850	219	24 300	241	46 250	263	87 500		

Example: 157 A8 a tire can carry maximum 4125 kg at the maximum speed of 40 km/h.

UNITS

Quantity	S.I. units	Other units
Length	m (metre)	1 inch (") = 0.0254 m (or 25.4 mm)
		1 mile = 1 609 m (or 1.609 km)
Mass	kg (kilogram)	1 pound (lb) = 0.4536 kg
Pressure	Pa (Pascal)	1 bar = 100 kPa
		1 pound per square inch (psi or lb/in ²) = 6.895 kPa
		1 kg/cm ² = 98.066 kPa
Speed	m/s	1 km per hour (km/h) = 0.277778 m/s
	(metre per second)	1 mile per hour (mph) = 0.4470 m/s (or 1.60935 km/h)

PICTOGRAM

MARKED ON BOTH TIRE SIDEWALLS

Expects the maximum inflation pressure not to be exceeded for bead seating during tire mounting. The value of inflation pressure (2.5 bar in the example) must be the same as specified by the tire manufacturer.



Speed symbol

The SPEED SYMBOL (SS) indicates the maximum speed at which the tire can carry a load corresponding to its Load Index.

SS	km/h	mph
A1	5	2.5
A2	10	5
A3	15	10
A4	20	12.5
A5	25	15
A6	30	20
A7	35	22.5
A8	40	25
B	50	30
C	60	35
D	65	40
E	70	43
F	80	50
G	90	55
J	100	62
K	110	68
L	120	75
M	130	81
N	140	87
P	150	93
Q	160	99
R	170	106
S	180	112
T	190	118

LOW SPOT MARKING (UPON REQUEST)

This marking is used for match-mounting tires on agricultural tractor wheels equipped with a high spot marking.

In the tire industry, **low spot marking** refers to the identification and marking of the area on a tire that has the lowest radial runout, meaning the point where the tire's tread or sidewall is closest to the center of the wheel. This process is crucial for ensuring optimal tire balance and reducing vibrations when the tire is mounted on a vehicle.

Key Details:

- **Radial Runout:** Radial runout is the measurement of how much a tire's radius varies as it rotates. Ideally, the tire should be perfectly round, but manufacturing imperfections can cause slight variations.
- **Low Spot:** The low spot is the point on the tire where the distance from the tire's center (or hub) to the tread or sidewall is the shortest. This is identified using specialized equipment that measures the tire's geometry.
- **Marking:** Once the low spot is identified, it is marked with a white colored dot on the tire's sidewall. This marking helps technicians during the tire mounting process.
- **Tire and Wheel Matching:** The low spot marking is used in conjunction with the high spot marking on the wheel (the point where the wheel's radial runout is the greatest) to optimize the mounting process. By aligning the tire's low spot with the wheel's high spot, the overall radial runout is minimized, which leads to a smoother ride and better tire performance.

This practice is part of the tire and wheel balancing process and helps to ensure that the vehicle operates smoothly and that the tires wear evenly over time.



PRESSURE UNIT, CONVERSION TABLE

kPa	bar	* lbs/in ² (psi)	* kg/cm ²	kPa	bar	* lbs/in ² (psi)	* kg/cm ²	kPa	bar	* lbs/in ² (psi)	* kg/cm ²	kPa	bar	* lbs/in ² (psi)	* kg/cm ²	kPa	bar	* lbs/in ² (psi)	* kg/cm ²
10	0.1	1	0.1	230	2.3	33	2.3	450	4.5	65	4.6	670	6.7	97	6.8	890	8.9	129	9.1
20	0.2	3	0.2	240	2.4	35	2.4	460	4.6	67	4.7	680	6.8	99	6.9	900	9.0	131	9.2
30	0.3	4	0.3	250	2.5	36	2.5	470	4.7	68	4.8	690	6.9	100	7.0	910	9.1	132	9.3
40	0.4	6	0.4	260	2.6	38	2.7	480	4.8	70	4.9	700	7.0	102	7.1	920	9.2	133	9.4
50	0.5	7	0.5	270	2.7	39	2.8	490	4.9	71	5.0	710	7.1	103	7.2	930	9.3	135	9.5
60	0.6	9	0.6	280	2.8	41	2.9	500	5.0	73	5.1	720	7.2	104	7.3	940	9.4	136	9.6
70	0.7	10	0.7	290	2.9	42	3.0	510	5.1	74	5.2	730	7.3	106	7.4	950	9.5	138	9.7
80	0.8	12	0.8	300	3.0	44	3.1	520	5.2	75	5.3	740	7.4	107	7.5	960	9.6	139	9.8
90	0.9	13	0.9	310	3.1	45	3.2	530	5.3	77	5.4	750	7.5	109	7.6	970	9.7	141	9.9
100	1.0	15	1.0	320	3.2	46	3.3	540	5.4	78	5.5	760	7.6	110	7.7	980	9.8	142	10.0
110	1.1	16	1.1	330	3.3	48	3.4	550	5.5	80	5.6	770	7.7	112	7.9	990	9.9	144	10.1
120	1.2	17	1.2	340	3.4	49	3.5	560	5.6	81	5.7	780	7.8	113	8.0	1000	10.0	145	10.2
130	1.3	19	1.3	350	3.5	51	3.6	570	5.7	83	5.8	790	7.9	115	8.1	1010	10.1	146	10.3
140	1.4	20	1.4	360	3.6	52	3.7	580	5.8	84	5.9	800	8.0	116	8.2	1020	10.2	148	10.4
150	1.5	22	1.5	370	3.7	54	3.8	590	5.9	86	6.0	810	8.1	117	8.3	1030	10.3	149	10.5
160	1.6	23	1.6	380	3.8	55	3.9	600	6.0	87	6.1	820	8.2	119	8.4	1040	10.4	151	10.6
170	1.7	25	1.7	390	3.9	57	4.0	610	6.1	88	6.2	830	8.3	120	8.5	1050	10.5	152	10.7
180	1.8	26	1.8	400	4.0	58	4.1	620	6.2	90	6.3	840	8.4	122	8.6	1060	10.6	154	10.8
190	1.9	28	1.9	410	4.1	59	4.2	630	6.3	91	6.4	850	8.5	123	8.7	1070	10.7	155	10.9
200	2.0	29	2.0	420	4.2	61	4.3	640	6.4	93	6.5	860	8.6	125	8.8	1080	10.8	157	11.0
210	2.1	30	2.1	430	4.3	62	4.4	650	6.5	94	6.6	870	8.7	126	8.9	1090	10.9	158	11.1
220	2.2	32	2.2	440	4.4	64	4.5	660	6.6	96	6.7	880	8.8	128	9.0	1100	11.0	160	11.2

* Values in psi and kg/cm2 rounded to the nearest practical unit.

SIZE EQUIVALENCY

mm dimension	Equivalent size
250/80R16	7.5R16
340/80R18	12.5R18
360/80R20	14.5R20
300/80R24	11.2R24
340/80R24	12.4R24
360/80R24	13.6R24
400/80R24	14.9R24
440/80R24	16.9R24
360/80R28	13.6R28
400/80R28	14.9R28
440/80R28	16.9R28
440/80R30	16.9R30
480/80R30	18.4R30
440/80R34	16.9R34
480/80R34	18.4R34
480/80R38	18.4R38
540/80R38	20.8R38
620/80R42	N.A.
270/75R15	N.A.
250/75R16	N.A.
500/70R24	19.5LR24

TIRE STRUCTURES



RADIAL TIRE

The tire carcass is stabilized by an inextensible circumferential belt

The ply cords are laid substantially at 90° to the centerline of the tread

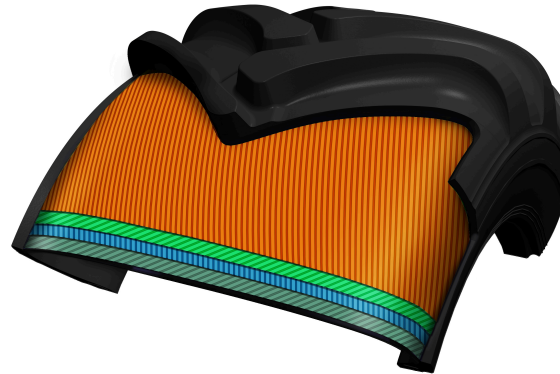

DIAGONAL (OR BIAS PLY) TIRE

The ply cords are laid at alternate angles substantially less than 90° to the centerline of the tread

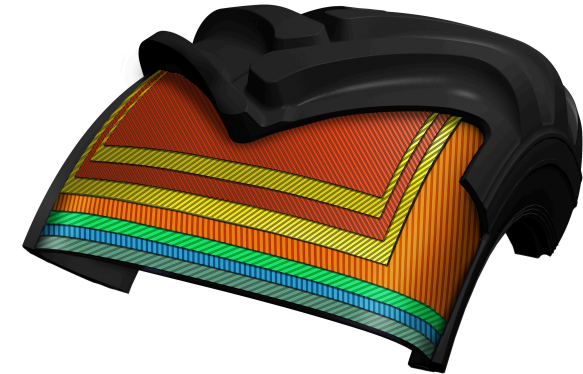

BIAS BELTED

The tire carcass is stabilized by an inextensible circumferential belt

Tire structure of diagonal tire

INFLATION PRESSURE

CHOOSING THE RIGHT INFLATION PRESSURE

MAINTAINING THE PROPER INFLATION PRESSURE

The inflation pressures of tires should be checked carefully at regular intervals. Perform a visual check daily and repeatedly when operating. A slow leak can cause damage to the tire sidewall or lead to tube failure before the under-inflation can be felt in the handling of the machine.

Repairable damage should be repaired immediately in order to help obtain regular tire life. When operating machinery in winter conditions, it should be kept in mind that when temperatures decrease, so do tire inflation pressures. Consequently, when inflating a tire indoors in winter, it should be inflated slightly over the recommended pressure. The diagram below should prove of assistance in determining the correct pressure.

GROUND DISTURBANCE

Ground disturbance is more pronounced when operating in soft soil conditions. When the tire gets in contact with the ground on a hard surface, it is the tire that gets depressed, whereas when operating on soft soil, the ground gets depressed. The inflation pressure should be less than the ground pressure between the ground and the tire, in case approx. 55 kPa, for it to reduce the depth of the footprint.

Consequently, it is not advisable to reduce tire inflation pressures in order to improve the machine's footprint, as it has a negative impact on the tire's service life. The use of wider tires and tires with VF technology will serve this

THE RELATIONSHIP BETWEEN TIRE INFLATION PRESSURE AND AIR TEMPERATURE

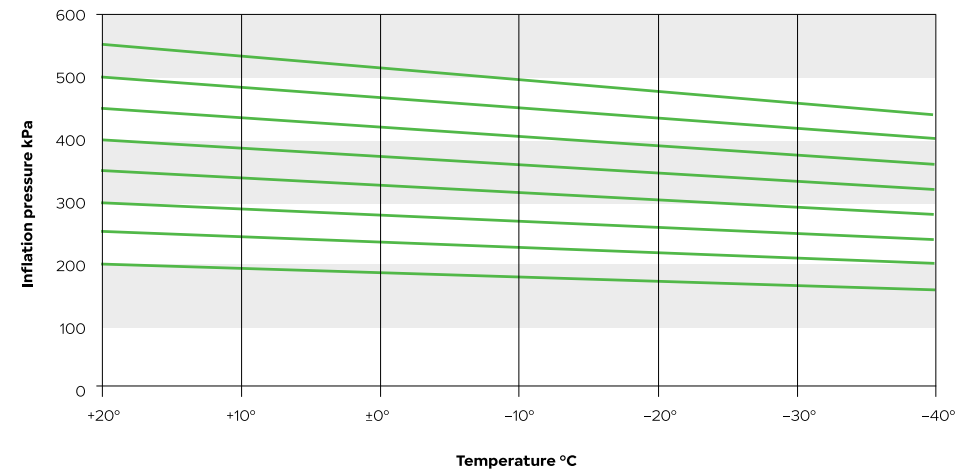

purpose better.

Nokian Tyres Soil King VF

LIQUID AND SALT BALLASTING

- Liquid ballasting is used to increase machine stability
- It is recommended to use professional tire outlets to carry out the filling procedure
- Special equipment and water permeable valves are required
- In liquid and salt ballasting, use tubes to prevent rims from rusting

Note! If a filler other than liquid is used (i.e. polyurethane), tire warranty does not apply.

Note! Do not use liquids or innertubes in tires fitted with sensors. The sensor warranty does not apply in case of damage caused by liquids or accessories such as innertubes.

WATER BALLASTING

75 % of the tire volume is filled. Amounts listed in the table below.

WATER AND SALT BALLASTING

The addition of salt will prevent freezing. 75% of the tire volume is filled with the proportions given in the table below. The salt / water solution is calculated at a temperature of -30 °C / -22°F. Normal commercial salt (CaCl₂), 77% purity, is used.

Any additional salt will not necessarily dissolve in water.

The remaining tire volume is inflated to the recommended inflation pressure.

Notice! Since tire has air only 25% of the original volume, regular inflation pressure checks are highly recommended.

TRACTOR AND LOADER TIRES FOR WINTER APPLICATION

Tractor and loader tyres are currently excluded from the scope of winter performance testing and certification established and enforced by supranational authorities UN ECE and European Commission.

In order to acquire the 3PMSF (Three-Peak Mountain Snowflake) “Alpine Symbol,” a tyre must be within the scope of UN ECE Regulation 117:

Tyre type: C1 (passenger car tyres), C2, C3 (truck and bus tyres)

- Vehicle type: M, N, or O (car, bus, truck, trailers)
- Tyre speed rating: F (80 km/h) or more
- Rim diameter: More than 10” and below 25”

In the absence of specific regulations, it is up to the manufacturer to choose to verify the winter performance properties of their tractor and loader tyres marketed for winter applications through their own test procedures.

The Nokian Heavy Tyres products developed and tested for high performance in winter applications include

Nokian Tyres TRI2, Nokian Tyres Hakkapeliitta TRI, and Nokian Tyres Hakkapeliitta Loader.

The marking “M+S” has been adopted by Nokian Tyres as an indication of suitability for winter applications based on winter testing.



Features of Nokian Heavy Tyres products for winter applications

- The materials used in the casing of the tyre withstand and maintain performance in sub-zero temperatures.
- The tread pattern material used in the tyres is developed for high friction on ice and snow, even in sub-zero temperatures.
- The pattern consists of multiple pattern elements with edges to enhance longitudinal and lateral grip for acceleration, braking, and steering on snow. In the case of Nokian Tyres Hakkapeliitta TRI and Hakkapeliitta Loader, the pattern also includes siping up to 80% of the pattern depth.

Winter performance testing for these tyres has been conducted at the Nokian Tyres Winter Testing Center in Ivalo, Finland.

NON-SKID CHAINS

Nowadays, the general tendency is to work increasingly without chains. This in turn places additional demands on forestry tire selection in order to ensure access to difficult terrain while, at the same time, minimising ground disturbance. In practise, however, there are situations when the use of chains cannot be avoided. In such cases, it is important to pay attention to some basic considerations.

USE OF CHAINS

Before installing new chains, it is recommended that they be inspected for sharp edges or welding burrs. When installing chains on a tire, it is important to ensure that the chains are sufficiently tight. Chains that are too loose can slip on the tire causing excessive wear.

Checking the functioning of old and worn chains is recommended from time to time as well. It is important to check that no chain rings are broken and that none of these individual rings have turned, so that their calks cut into the tire. The same damage can occur with severely worn and thus overstretched chains.



TRACKS

Track manufacturers give their recommendations in slightly different ways. The practice, that is becoming increasingly common, is where track manufacturers specify their products according to the tire manufacturer, the tread design and the tire size. The minimum requirement is that the track manufacturer provide the tire size and the tread design for each track type.

When acquiring tracks, it is extremely important

for the user to select the correct track type which is suitable for the tire and that the operating pressure, in particular, meets the recommendations of track manufacturers. When selecting tracks, it is recommended that the user contacts the track manufacturer.

When using tracks the correct pressure level is the maximum permitted inflation pressure for each tire size.

RECOMMENDED INFLATION PRESSURES WHEN USING TRACKS

Tire size	PR	LI / SS	kPa	psi
500/60-22.5	16		430	62
600/50-22.5	16	151 A8 / 158 A2	430	62
700/45-22.5	16		390	57
710/40-22.5	16	154 A8 / 161 A2	390	57
710/40-24.5	20	163 A8 / 190 A2	550	80
600/55-26.5	16		460	67
700/45-26.5	16		460	67
710/45-26.5	16	161 A8 / 168 A2	460	67
600/55-26.5	20	165 A8 / 172 A2	550	80
650/65-26.5	20	172 A8 / 179 A2	550	80
700/50-26.5	20		550	80
710/45-26.5	20	168 A8 / 175 A2	550	80
750/55-26.5	20	177 A8 / 184 A2	550	80
780/55-26.5	20	179 A8 / 186 A2	550	80
800/40-26.5	20	170 A8 / 177 A2	550	80
650/45R24.5		161 A8 / 168 A2	550	80
600/55R26.5		165 A8 / 172 A2	550	80
710/45R26.5		168 A8 / 175 A2	550	80
800/50R26.5		180 A8 / 187 A2	550	80

Notice! Contact the track manufacturer for the correct track for your tire.



RIMS

STANDARDS

Tires are designed for use on rims that meet the industry standards. It is the responsibility of the vehicle manufacturers and vehicle users that rims used comply with these standards.

The right tire and rim combination defined in these standards guarantees a proper mounting and fit of tire on the rim. Standards manuals give the proper rim dimensions and the right rim contours for use on each tire size and service condition.

Rims and wheels may be stamped with maximum load and maximum cold inflation ratings. If these are not identified consult the rim and wheel manufacturer for rim and wheel capacities for the intended service.



Tire and rim standards manuals.

TRA	The Tire and Rim Association Inc.
ETRTO	The European Tire and Rim Technical Organisation
JATMA	The Japan Automobile Tire Manufacturers Association Inc.
STRO	The Scandinavian Tire & Rim Organisation

INFORMATION NEEDED FOR DEFINING A WHEEL

A wheel consists of a rim and a disc. Rim contours are standardised and differ from each other according to the service type. Wheel discs are characterised by the offset position, attachment and centre hole.

To define a wheel for a certain application, the following information is needed by the wheel manufacturer:

INFORMATION FROM THE TIRE MANUFACTURER:

1. Tire size, loading requirements and service type
2. Nominal width code (inch)
3. Diameter code (inch)
4. Tubeless or tube-type tire

With this tire information the rim contour can be designed.

INFORMATION FROM THE VEHICLE MANUFACTURER:

5. Offset
6. Disc centre hole
7. Attachment (bolt circle diameter, bolt hole size, bolt hole type)
8. Wheel loading and maximum speed requirements
9. Valve hole placement, type of valve preferred and need for valve protection
10. The wheel colour

With this information a standard or a tailored wheel can be defined.

Notice! When in doubt consult rim and wheel manufacturer for confirmation on the strength of the rim/wheel for the intended service.

RIM MARKINGS

Disc wheels and demountable rims shall be marked with the following information:

- a) Rim size designation
- b) Wheel/rim manufacturer (name, symbol or trademark)
- c) date of manufacture
- d) part number or code

Rings shall be marked with the following information:

- a) Identification of rim to which the part may be fitted
- b) Identification of manufacturer
- c) Date of manufacture
- d) Flange height designation (on side rings for EM rims)

Notice! With recommended rim you get the best operational result from your tire. You may use also permitted rim as an alternative.

Notice!
 - indicates multi-piece rim.
 x indicates one-piece rim.

Rim marking			Rim contour		Nominal diameter code	Special features
			Width code	Profile		
61/2J x 15 H2	or	15 x 61/2J H2	6 1/2	J	15	Asymmetrical drop-centre, double hump (H2). (if S=symmetrical)
225 x 750			7.5		22.5	
10.00 V -20	or	20 - 10.00 V	10	V	20	
DW16L x 26	or	26 x SW 16L	16	L	26	Secondary Well (DW)
8.00TG - 24 SDC	or	24 - 8.00TG SDC	8.00	TG	24	Semi-Drop Centre (SDC)
11.25 - 25/2.0	or	25 - 11.25/2.0	11.25		25	Flange Height Code (/2.0)

WHEEL STUD HOLES AND COUNTER SINKS

WHEEL CONNECTION TO THE HUB

The stud/bolt holes in the wheel's center disc together with the center hole define the wheel's connection to the hub. To make sure the wheel is connected centrally, the wheel has two options.

One is to center the wheel via the center hole using a specified tolerance, then typically the bolt/stud holes are straight. This solutions is often used for example in tractors.

The other is to use chamfered bolt/stud holes, which enables the wheel to center itself using the holes geometry. In that case the tolerance of the center hole is slightly larger.

Bolt Hole Diameters d_1	Countersink Type			
	Spherical Countersink		Conical countersink	
	Sphere Radii - r	Spherical countersink outside diameter - d_2	Countersink angles - α	Conical countersink outside diameter - d_2
18	16	27	60	22
20	18	29	90	27
21		32		29
21.5				32
22				35
24				
25.4				
26				
27				

COUNTERSINK TYPE

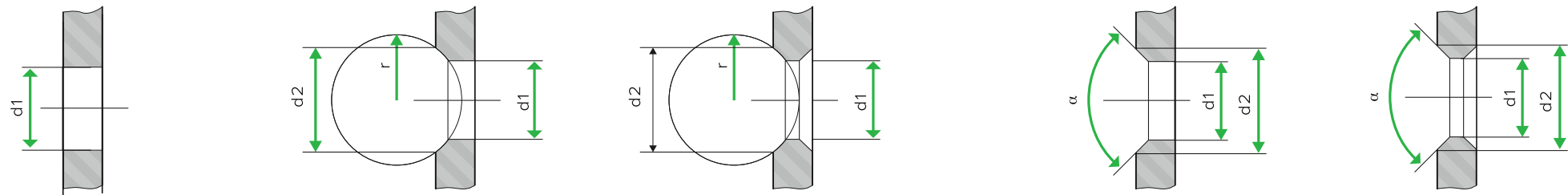

TYPICAL SPHERICAL COUNTERSINK

Countersink Designation	Bolt Hole Diameter d1	d2	sphere R	Countersink Description	EUWA	Inside/ Outside/Both
A2	21.5	27	16	AR/D16-27	B18 ES 32	Outside
A3	27	32	18	AR/D18-32	B22 ES 36	Outside
B2	21.5	27	16	BR/D16-27	B18 DS 32	Both
B3	27	32	18	BR/D-18-32	B22 DS 36	Both

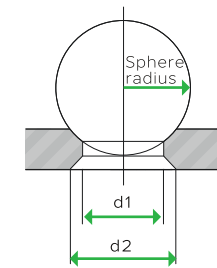
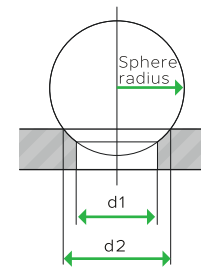

EUWA 3.15 Stud Hole Designation With A Spherical Countersink

B	Bolt Centric
M	Hub Centric
27	Stud Hole Diameter
I	Inside
E	Outside
D	Both
S	Spherical
36	Sphere diameter

Stud hole code Spherical type of stud hole

B	stud centring
M	hub centering / double centering
22	stud diameter
I	counter sink inside
E	external
D	double side
S	spherical
36	sphere diameter

Example

according to EUWA	
countersink external	B22 ES 36
countersink inside	B22 IS 36
countersink designation	A3

Example

according to EUWA	
countersink double side	B22 DS 36
countersink designation	B3

TYPICAL CONICAL COUNTERSINK

Countersink Designation	Bolt Hole Diameter d1	Conical countersink outside diameter - d2	Countersink angles - α	Countersink Description	EUWA	Inside/ Outside/ Both
A21	21.5	27	90	A90-27	-	Outside
B21	21.5	27	90	B90-27	-	Both

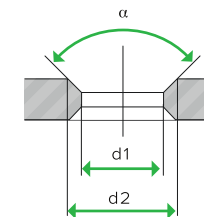
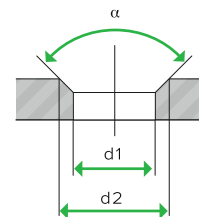

EUWA 3.15 Stud Hole Designation With A Conical Countersink

B	Bolt Centric
M	Hub Centric
27	Stud Hole Diameter
I	Inside
E	Outside
D	Both
C	Conical
60	Angle

Stud hole code Conical type of stud hole

B	stud centring
M	hub centering / double centering
23	stud diameter
I	counter sink inside
E	external
D	double side
C	conical
80	angle

Example

according to EUWA	
countersink external	B23 EC 80
countersink inside	B23 IC 80
countersink designation	A17

Example

according to EUWA	
countersink double side	B23 DC 80
countersink designation	B17

CYLINDRICAL (PLAIN STUD HOLES, HUB CENTRIC)

Bolt Hole Diameter d1	EUWA
18	
20	
21	M18
21.5	
22	
24	M20
25.4	
26	M22
27	

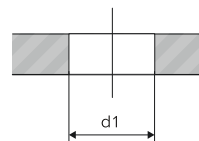

Example

according to EUWA	
cylindrical stud hole	M22

RIM CONTOURS

There are mainly two types of rims used with Nokian Heavy Tyres products. Wide well-base and flat-base contour designs.

1. WIDE WELL-BASE (W AND DW)

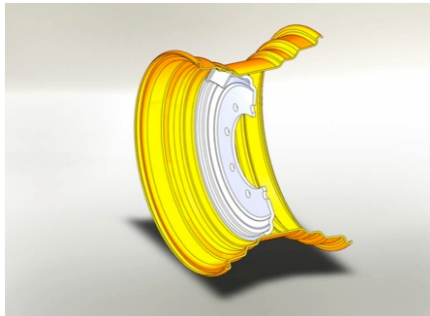

DW rim

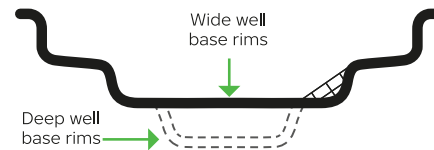

Wide (wide well) and DW (deep well) rim contours

W OR DW?

DW facilitates better the mounting of high PR (stiffer construction) tires. DW rims also have higher strength compared with W rims, due to more bends in the contour shape.

2. FLAT BASE RIMS

Flat base rims are generally of divided construction or equipped with lock rings.



Flat base rim

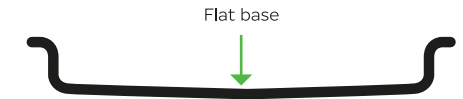

Flat base rim contour

WHEEL (DISC INCLUDED) MAIN DIMENSIONS

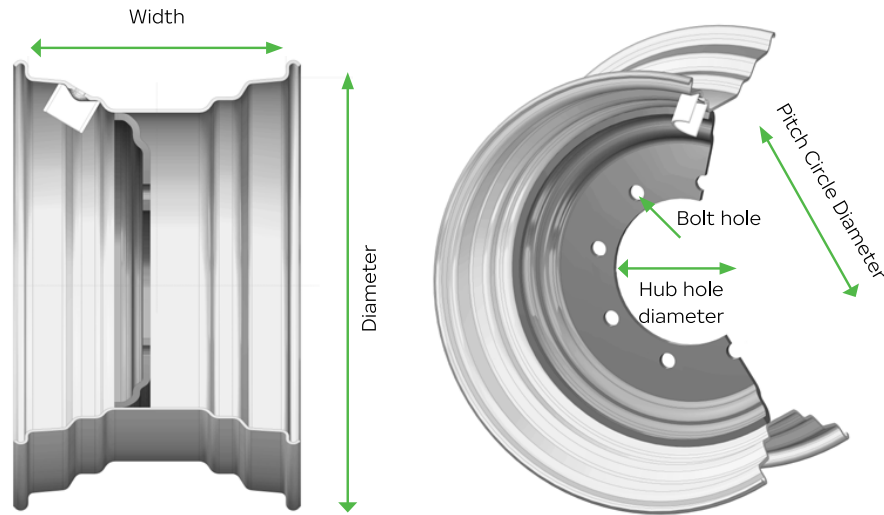

+ OFFSET DECREASES TRACK WIDTH

- OFFSET INCREASES TRACK WIDTH

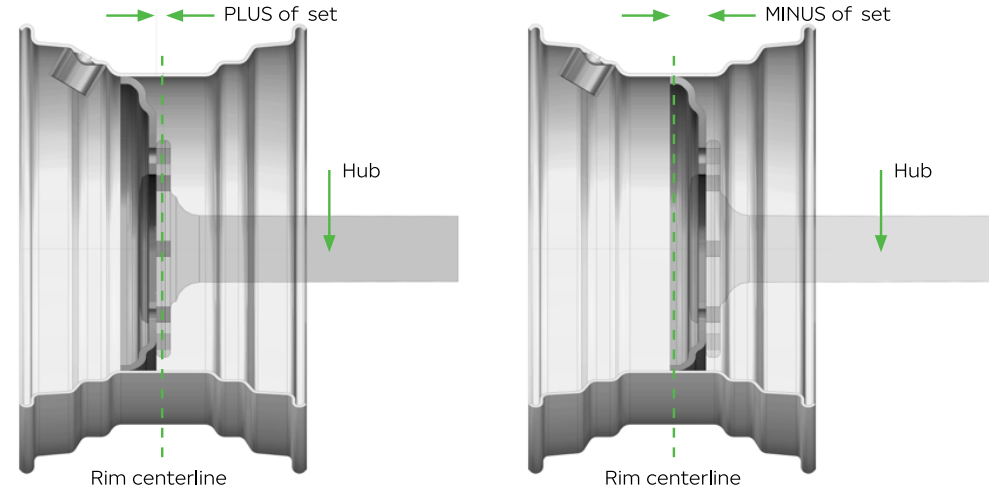

DISC HOLE DEFINITION (MM)

281	335	25,4	10	AR18-32
				Countersink
				Number of holes
				Bolt hole diameter
				Pitch circle diameter (PCD)
				Hub hole diameter

Offset is the distance from the rim centerline to the hub mounting surface

+ offset decreases track width

- offset increases track width

WHEEL PARTS / COMPONENTS

SINGLE PIECE WHEEL

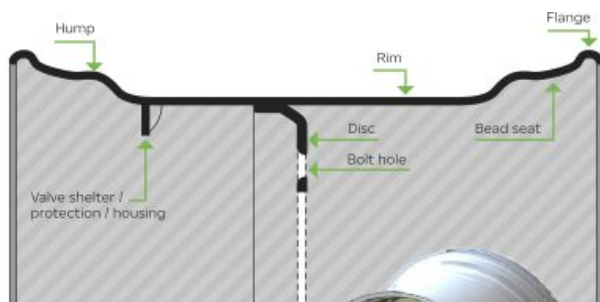

AG wheel with 2 humps (H2)



VALVE PROTECTORS

In tough operating conditions, i.e. forestry a R2" thread valve protector is commonly used. A transparent cap enables the use of LED pressure warning device.



R2" valve protector



Transparent cap for R2"



Other types of valve protectors depending on user preferences



FORESTRY RIMS

EXAMPLES OF TYPICAL FORESTRY RIM SIZES

AG 22.00 x 22.5 All 15° tapered
 AG 24.00 x 24.5
 AG 24.00 x 26.5
 AG 28.00 x 26.5

DW 20 B x 26 All 5° tapered
 DW 25 B x 26
 DW 23 B x 34
 DW 24 B x 34

AG = agricultural rim contour (drop centre rims)

DW = deep well rims

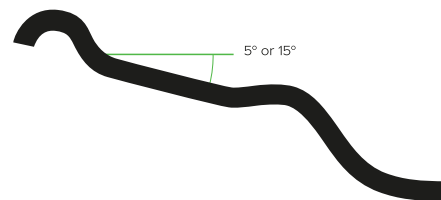

15° tapered in diameter codes xx.5
 5° tapered in diameter codes xx

REINFORCEMENTS

Rims used in professional logging operations are recommended to have contour flange reinforcements. These add load carrying capacity and protect flanges against impacts.



1) Rim diameters 24,5" and larger

Recommendation: Flat bar steel on the outside flange. Round steel / tube edge / long rolled flange on the inside flange.



2) Rim diameters smaller than 24,5"

Recommended reinforcements depending on loading and operating conditions. Types:

- Round steel
- Tube flange edge
- Long rolled flange edge



Forestry rim with flat bar steel reinforcement

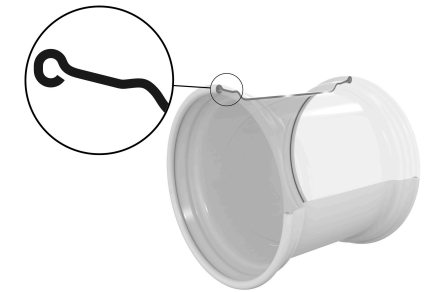

Tube flange edge

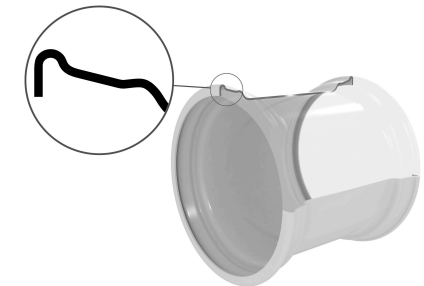

Long rolled flange edge

KNURLING

Knurling has been designed to prevent tire slippage on rim caused by the inherent traction force on the wheel. To produce the desired effect, knurling must extend beyond the surface of the rim bead seat.

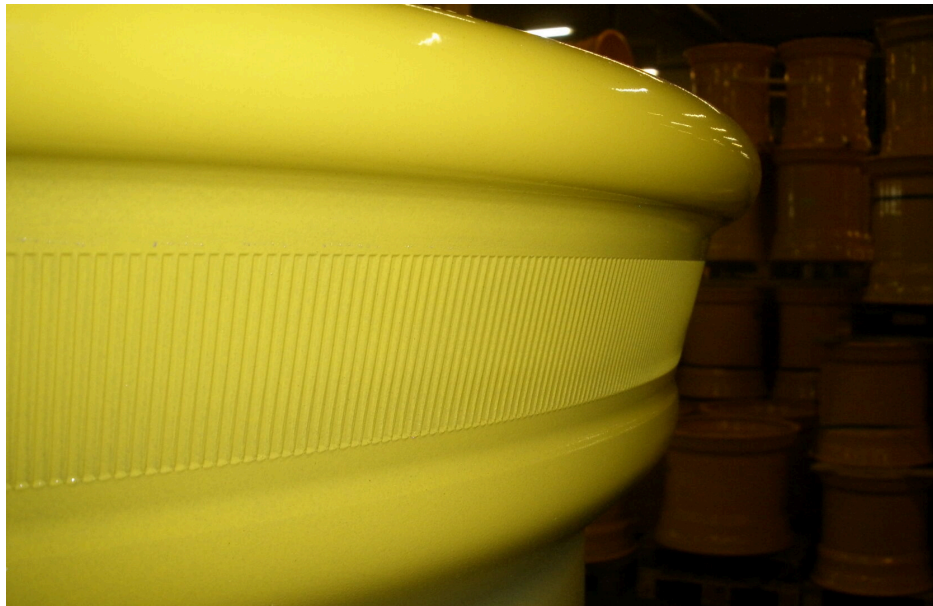

Knurling for tire slippage on rim prevention

Other methods to prevent tire slippage on rim

- Friction paint on bead area
- Paint removed from bead area

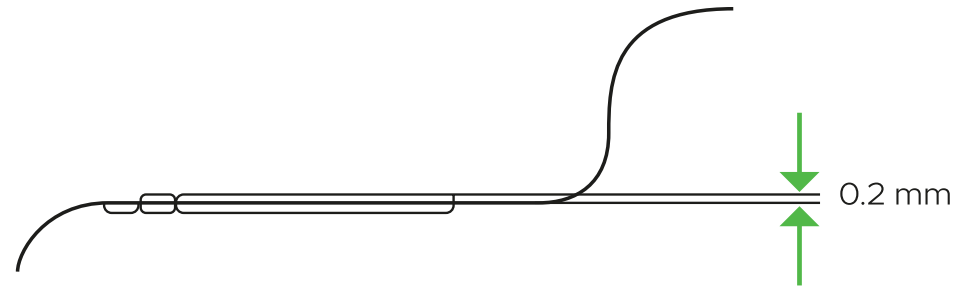

RECOMMENDATIONS FOR KNURLING USE ON 5° TAPERED RIM CONTOURS

Rim width	Rim Diameter	Rim Diameter 24" and larger
13" and smaller	Upon request	Upon request
14" in smaller	Upon request	Always

Knurling conditions (ETRTO)

Notice!

For preventing tire slippage on rim:

1. Proper inflation pressure.
2. Use high quality standards fulfilling rims.

TUBELESS FORESTRY RIMS

With the introduction of radial forestry tires (Forest Rider), Nokian Heavy Tyres is able to offer tubeless wheels for forestry.

Advantages:

1. No need for tubes and regular tube maintenance
2. No tube valve break-ups from occasional tire wheel spins in severe high torque conditions.
3. If a wheel spin should occur it has no effect on wheel functionality

A tubeless forestry rim has 3 differences compared with a standart similar contour agricultural rim.

1. Rim flange reinforcements
2. Knurling
3. 15° tapered rims with wider hump dimensioning to accomodate stiffer and wider tire bead area.

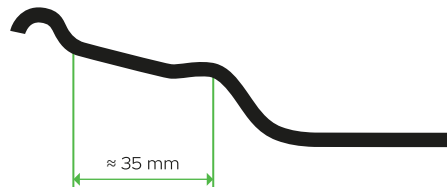

Traditional agricultural rim hump dimensioning

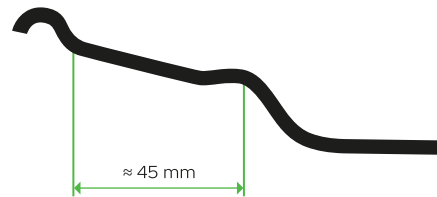

Forestry rim hump dimensioning to accomodate wider tire base

Notice!

Rims with wider hump can be used also in agricultural and forestry trailer tires.
5° tapered rims don't require humps to perform as tubeless (i.e. 34" Forest Rider sizes).

AGRICULTURAL RIMS

Agricultural rims are TL (tubeless) type. Rim material, rim shape (contour) and material thickness are based on wheel loading requirements.

EXAMPLES OF AGRICULTURAL RIM SIZES

13.00 x 15.5	All 15° tapered agricultural rim sizes are equipped with humps.
16.00 x 17	5° tapered sizes don't require humps for tubeless use.
AG 13.00 x 22.5	
AG 20.00 x 26.5	
DW 13 x 24	
DW 15 x 24	

INDUSTRIAL AND EM MULTI-PIECE WHEELS

WHEEL PARTS/COMPONENTS



3-piece rim / bead set ring, side ring and lock ring the same component

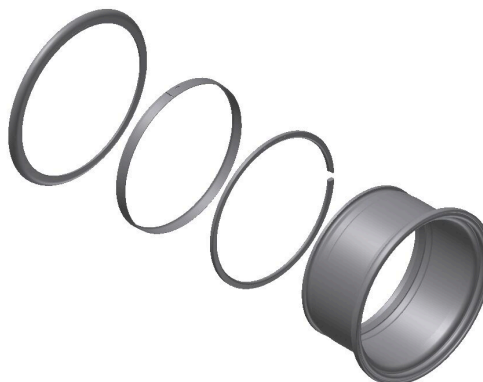

4-piece rim / bead set ring and lock ring the same component

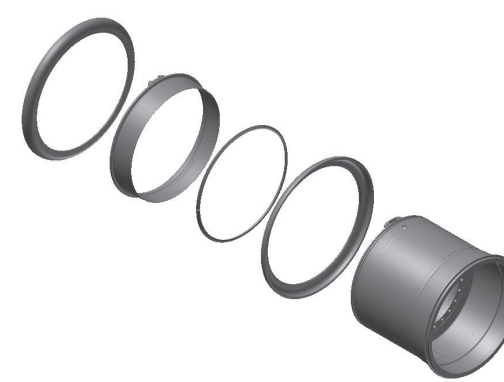

5-piece rim / all parts separate

Notice!

Always check that rim load capacity meets or exceeds tire load capacity. As wheel is a highly stressed component it must be inspected periodically.

Safety and service recommendations for wheels:
www.euwa.org/safety-informations/safety-service

Notice!

Wheel, when disc included. Rim, when no disc included.

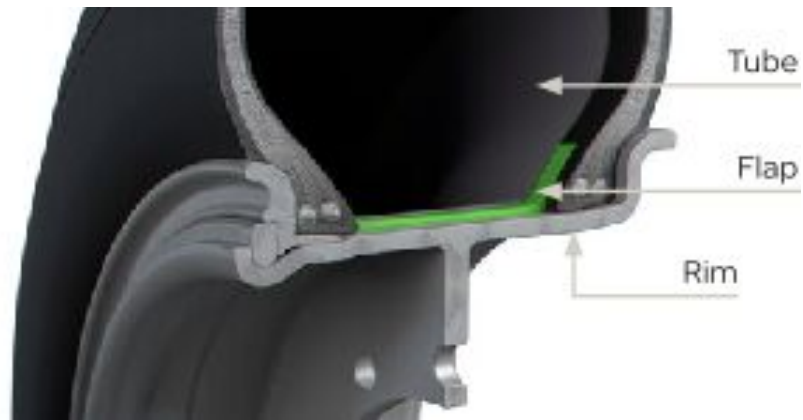

MULTI-PIECE RIMS 20" AND 24"

Generally tube-type wheels, requiring a tube and a flap.

Examples of tire sizes:

- 12.00 - 20
- 14.00 - 24

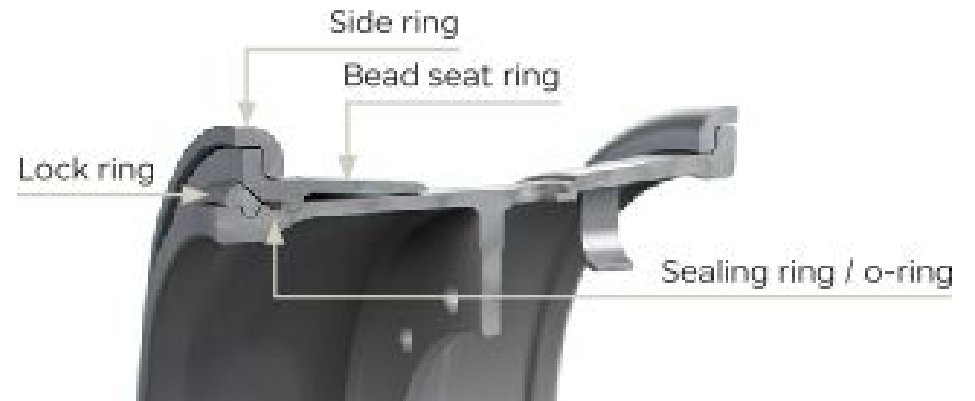

MULTI-PIECE RIMS 25", 29" AND 33"

Generally tubeless wheel, requiring a sealant ring (o-ring).

Examples of tire sizes:

- 17.5 R 25
- 16.00 R 25
- 18.00 - 25
- 18.00 - 33

FLAPS

Product code	Description	Tire sizes
T299520	FLAP 170-20	9.00-20, 10.00-20
T299530	FLAP 195-20	11.00-20, 12.00-20 (rim 8.0)
T299537	FLAP 255-20	12.00-20
T299538*	FLAP 260-20	14.00-20
T299531*	FLAP 260-24/25	12.00-24, 14.00-24, 16.00-24, 16.00-25
T299551	FLAP 350-25	17.5-25, 18.00-25
T299552	FLAP 500-25	23.5-25

*) Flap valve hole made afterwards depending on required positioning

O-RINGS

O-ring code	Nokian Tyres O-ring product code	Rim contours
OR-224	HTOC 00013	10.00VA
OR-225	HTOC 00003	12.00/1.3, 14.00/1.5
OR-325	HTOC 00004	10.00WA, 11.25/20, 13.00/2.5, 15.00/2.5, 17.00/2.0, 19.50/2.5, 22.00/3.0, 25.00/3.5
OR-329	HTOC 00008	22.00/3.0, 25.00/3.5
OR-333	HTOC 00011	13.00/2.5

OR-2XX: OR: O-ring, 2XX: O-ring diameter: 2: 2/8 inch = 6.35 mm / 3: 3/8 inch = 9.53mm

TUBE, FLAP AND O-RING SUITABILITY

Tire product code	Name	Tube product code	Tube description	Flap product code	Flap description	O-ring*	O-ring description
T445562	9.00-20 16 ARMOR GARD MINE	T52520	9.00 -20 TR 175 TUBE	T299520	FLAP 170-20		
T445451	10.00-20 16 ARMOR GARD	T52620	10.00-20 TR 78 TUBE	T299520	FLAP 170-20		
T445649	10.00-20 16 ARMOR GARD 2 TT	T52620	10.00-20 TR 78 TUBE	T299520	FLAP 170-20		
T445450	11.00-20 16 ARMOR GARD	T52720	11.00-20 TR 179 TUBE	T299530	FLAP 195-20		
T445459	12.00-20 20 ARMOR GARD	T52810	12.00-20 V3.02.16 TUBE	T299537	FLAP 225-20		
T445449	12.00-20 20 ARMOR GARD MINE	T52810	12.00-20 V3.02.16 TUBE	T299537	FLAP 225-20		
T445544	12.00-20 20 MINE KING L-5S TT	T52810	12.00-20 V3.02.16 TUBE	T299537	FLAP 225-20		
T445617	14.00-20 178A2 MINE KING E-4	T52920	14.00-20 TR 274 TUBE	T299537	FLAP 225-20		

Tire product code	Name	Tube product code	Tube description	Flap product code	Flap description	O-ring*	O-ring description
T488311	14.00-24 28 HTS E-3 TL	T55767	14.00-24 TR 1175 TUBE	T299531	FLAP 260-24/25	HTOC00004	OR-325
T445456	14.00-24 28 MINE E-3 TL	T55767	14.00-24 TR 1175 TUBE	T299531	FLAP 260-24/25	HTOC00004	OR-325
T445471	14.00-24 28 RTG TL	T55767	14.00-24 TR 1175 TUBE	T299531	FLAP 260-24/25	HTOC00004	OR-325
T493551	14.00R25 153A8 GRS TL	T55767	14.00-24 TR 1175 TUBE	T299531	FLAP 260-24/25	HTOC00013	OR-224
T445463	15.5R25 152B/169A2 LOADER GRIP 2 L-3 TL	T55810	16.00-25 TR J1175 BUT	T299551	FLAP 350-25	HTOC00003	OR-225
T488431	16.00-25 36 HTS E-4 TL	T55810	16.00-25 TR J1175 BUT			HTOC00004	OR-325
T445540	17.5-25 24 MINE KING L-5S TL	T55867	17.5-25 TR J1175 TUBE	T299551	FLAP 350-25	HTOC00003	OR-225
T445580	17.5-25 34 MINE KING L-5S TL	T55867	17.5-25 TR J1175 TUBE	T299551	FLAP 350-25	HTOC00003	OR-225
T493560	17.5R25 153A8 GRS TL	T55867	17.5-25 TR J1175 TUBE	T299551	FLAP 350-25	HTOC00003	OR-225
T445255	17.5R25 157V/176A2 LOADER GRIP L-3 TL	T55867	17.5-25 TR J1175 TUBE	T299551	FLAP 350-25	HTOC00003	OR-225
T445590	17.5R25 176A2/153A8 HAKKAPELIITTA LOADER L-2 TL	T55867	17.5-25 TR J1175 TUBE	T299551	FLAP 350-25	HTOC00003	OR-225
T445545	18.00-25 32 MINE KING L-5S TL	T55831	18.00/ 20.5/ 23.5/ 25/65-25 TR J1175 TUBE	T299551	FLAP 350-25	HTOC00004	OR-325
T445637	18.00-25 40 HTS G2 E-4 TL	T55831	18.00/ 20.5/ 23.5/ 25/65-25 TR J1175 TUBE			HTOC00004	OR-325
T445638	18.00-25 40 HTS G2 L-4S TL	T55831	18.00/ 20.5/ 23.5/ 25/65-25 TR J1175 TUBE			HTOC00004	OR-325
T445468	18.00-25 40 RTG E-3 TL	T55831	18.00/ 20.5/ 23.5/ 25/65-25 TR J1175 TUBE			HTOC00004	OR-325
T445514	18.00-33 40 HTS E-4 TL					HTOC00011	OR-333
T445458	18.00-33 40 HTS L-4S TL					HTOC00011	OR-333
T445171	20.5R25 168B/186A2 LOADER GRIP L-3 TL	T55831	18.00/ 20.5/ 23.5/ 25/65-25 TR J1175 TUBE	T299540	FLAP 430-25	HTOC00004	OR-325

Tire product code	Name	Tube product code	Tube description	Flap product code	Flap description	O-ring*	O-ring description
T445591	20.5R25 186A2 HAKKAPELIITTA LOADER L-2 TL	T55831	18.00/ 20.5/ 23.5/ 25/65-25 TR J1175 TUBE	T299540	FLAP 430-25	HTOC00004	OR-325
T445223	23.5R25 176B/195A2 LOADER GRIP L-3 TL	T55831	18.00/ 20.5/ 23.5/ 25/65-25 TR J1175 TUBE	T299552	FLAP 500-25	HTOC00004	OR-325
T445592	23.5R25 195A2 HAKKAPELIITTA LOADER L-2 TL	T55831	18.00/ 20.5/ 23.5/ 25/65-25 TR J1175 TUBE	T299552	FLAP 500-25	HTOC00004	OR-325
T445546	26.5-25 36 MINE KING L-5S TL					HTOC00004	OR-325
T445522	26.5-25 36 MINE L-3S TL					HTOC00004	OR-325
T845483	26.5R25 NORDMAN MINE E-4 TL					HTOC00004	OR-325
T445547	29.5-29 40 MINE KING L-5S TL					HTOC00008	OR-329
T845482	29.5R25 NORDMAN MINE E-4 TL					HTOC00004	OR-325

*) O-ring listed is always delivered with the tire

INSPECTIONS ON RIMS

ALLOWED WHEEL RADIAL- / LATERAL RUN-OUTS

Tolerances of the rim radial-/lateral run-out in agricultural and industrial use.

Nominal rim diameter	STRO radial / lateral		DIN 7823 radial / lateral	
	mm	32 nds in	mm	32 nds in
15" - 20"	2.5 / 2.5	3.2 / 3.2	3.5 / 3.5	4.4 / 4.4
22" - 28"	3.5 / 3.5	4.4 / 4.4	3.5 / 3.5	4.4 / 4.4
30" - 38"	5.0 / 5.0	6.3 / 6.3	5.0 / 5.0	6.3 / 6.3

MANDREL GAUGE

- Tolerance o the mandrel circumference is +/- 1.2mm
- Even a small under-swing on circumference accelerates the wearing of the rim and leads to tire rotation on the rim or bead chafing
- Crossing on circumference can cause a tire damage already when fitting the tire on to the rim

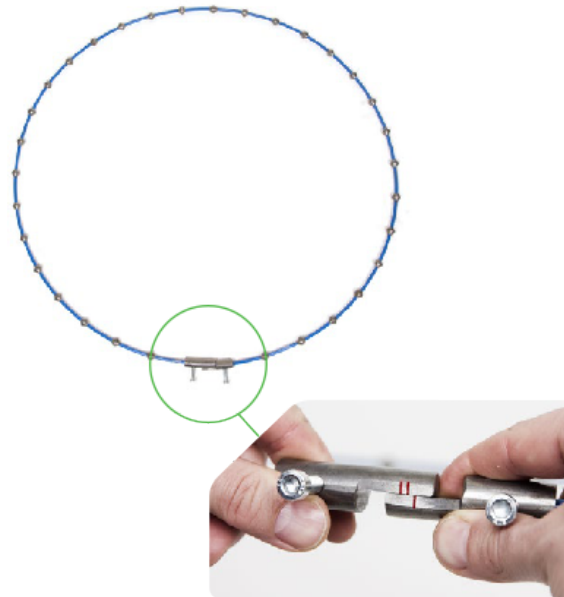

CONTOUR GAUGE

- If the flange is worn out or bent it does not support the bead of the tire and can cause bead chafing and ruin the tire



TIRE MOUNTING CLAMPS

Mounting clamp is developed and tested to make mounting easier.



1. Jaw shape is designed to fit with most common reinforced rims. See Suitability table for rims whose compatibility has been tested by Nokian Tyres.
2. Comfortable to handle and doesn't damage the tire
3. Made to last: material thickness 15 mm, screw M20
4. Tommy screws movable pin makes tightening easier

TIRE MOUNTING CLAMPS BY NOKIAN HEAVY TYRES

AG Single Clamp Mounting	→		
		Clamp AG Small	
AG Dual Clamp Mounting	→		+
		Clamp AG Big	Clamp AG Small
DW/TW/DH Single Clamp Mounting	→		
		Clamp DW/TW/DH Small	
DW/TW Clamp Mounting	→		+
		Clamp DW/TW Big	Clamp DW/TW/DH Small
DH Dual Clamp Mounting	→		+
		Clamp DW/TW/DH Small	Clamp DH Big

TECHNICAL SPECIFICATIONS

Product code	Description	Suitable rim profiles	Suitable tires	Weight (kg)	Dimensions (mm)	Notes
HTTMC00001	Tyre mounting clamp AG Big	AG (15°)	Nokian Forestry and Exavator tires fitted on AG 15° profile rims	5	300 x 340 x 40	Used for AG profile rims in dual clamp mounting as an assistant clamp with smaller HTTMC00002. If rim is with hump design, this clamp fits to WB(Wide Bead) version.
HTTMC00002	Tyre mounting clamp AG Small	AG (15°)	Nokian Forestry, Excavator and Agricultural tires fitted on AG 15° profile rims	4.3	210 x 265 x 40	Used for AG rims in single clamp mounting and in dual clamp mounting with HTTMC00001.
HTTMC00003	Tyre mounting clamp DW/TW Big	DW / TW (5°)	Nokian Forestry and Agricultural tires fitted on 5° DW / TW profile rims	8.5	440 x 400 x 40	Used for DW/TW profile rims in dual clamp mounting as an assistant clamp with smaller HTTMC00004.
HTTMC00004	Tyre mounting clamp DW/TW/DH Small	DW / TW / DH (5°)	Nokian Forestry, Skidder and Agricultural tires fitted on 5° DW / TW / DH profile rims	5.5	385 x 350 x 40	Used for DW, TW and DH profile rims in single clamp mounting and in dual clamp mounting with HTTMC00003 or HTTMC00005. In DH rims if dual steel plate welded in rim flange, this mounting clamp doesn't fit.
HTTMC00005	Tyre mounting clamp DH Big	DH (5°)	Nokian Skidder tires fitted on 5° DW profile rims	7.9	445 x 385 x 40	Used for DW profile rims in dual clamp mounting as an assistant clamp with smaller HTTMC00004. If dual steel plate welded in rim flange, this mounting clamp doesn't fit.

For detailed mounting instruction videos, please see:

- » **Excavator tire mounting**
- » **Skidder tire mounting**
- » **CTL tire mounting**

TUBES AND VALVES

TUBE MOUNTING

With properly done mounting, the risk of premature tube failure can be virtually eliminated. A so called dual inflation and the use of talcum powder will help ensure that no air gets trapped between the tire and the tube upon installation.

Use of improper or excessive lubricants can lead to rim slippage. This will cause the valve to tear off, which can cause damage to the entire tire.

For detailed mounting instruction videos, please see:

- » **Excavator tire mounting**
- » **Skidder tire mounting**
- » **CTL tire mounting**

INSTRUCTIONS ON TUBE REPLACEMENT HOURS AND INFLATION PRESSURE CHECK-UPS

REPLACEMENT INSTRUCTION

Severe working conditions:

Replace with new tubes every 5 000 hours.

Less demanding conditions:

Replace with new tubes every 8 000 – 10 000 hours.

This guideline applies when instructed inflation pressures for the given application are used. This guideline applies when inflation pressure check-ups are regular.

INSTRUCTION ON REGULAR INFLATION PRESSURE CHECK-UPS

- To be part of the normal forestry machine service procedure
- To be done every at least every 500 working hours

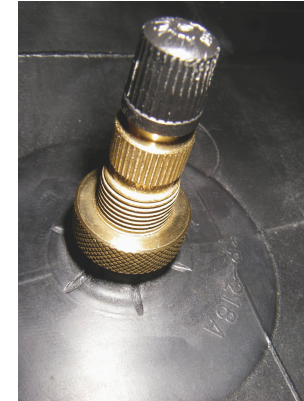

Example of a valve

Notice!

Do not use innertubes in tires fitted with sensors. The sensor warranty does not apply in case of damage caused by accessories such as innertubes.

Notice!

Use only Nokian Tyres tubes for optimal tube life.

Notice!

If pressure instructions and regular inflation pressure check-ups are not applied, tube damages can occur prematurely, even before the minimum 5 000 hour replacement interval.

TIRE CHOICE AND INFLATION PRESSURES BY APPLICATION

KOMATSU

Harvesters	Forwarders
• 901	• 825TX
• 901XC	• 830.3
• 911	• 840TX
• 931	• 835
• 931XC	• 840.4
• 941	• 845
• 951	• 855.1 / 855.2
• 951XC	• 860.4
	• 865
	• 875
	• 890.3
	• 895

CATERPILLAR

	Forwarders
	• 584
	• 584 HD

JOHN DEERE

Harvesters	Forwarders
• 1070E	• 810E
• 1070G	• 910G
• 1170E	• 910/1010G
• 1170G	• 1010E
• 1270E	• 1010G
• 1270G	• 1110G
• 1470E	• 1210G
• 1470G	• 1510G
	• 1910E
	• 1910G

LOGSET

Harvesters	Forwarders
• 4H	• 4F
• 5H	• 5F
• 6H	• 6F
• 8H	• 8F
• 10H	• 10F
	• 12F

PONSSE

Harvesters	Forwarders
<ul style="list-style-type: none"> • Beaver • Fox • Scorpion • Scorpion King • Cobra • Ergo • Bear 	<ul style="list-style-type: none"> • Gazelle • Wisent / Dual • Elk • Bison • Buffalo / Dual • Buffalo / Dual / ADS • Buffalo King • Elephant • Elephan King

ROTTNE

Harvesters	Forwarders
<ul style="list-style-type: none"> • H8 • H11 • H11c • H14c • H20b • H21d 	<ul style="list-style-type: none"> • F10b • F10d • F11d • F13c • F15c • F18 • F20







TIGERCAT





Harvesters	Forwarders
<ul style="list-style-type: none"> • 1165 • 1185 	<ul style="list-style-type: none"> • 1055C • 1075C • 1085C







ECOLOG







Harvesters	Forwarders
<ul style="list-style-type: none"> • 1058H5 • 550F • 550 T-PRO • 560F • 590F • 688F 	<ul style="list-style-type: none"> • 750F • 1050F • 1250F • 574F • 584F • 594F







KOMATSU HARVESTERS

Machine	Tire size / PR	Tread pattern							Inflation pressure					
		 F2	 TRS 2	 TRS 2+	 F *Nordman F	 Rider	 ELS	 TRS *Nordman TRS	Front		Rear		Max. inflation and track pressure	
								kPa	psi	kPa	psi	kPa	psi	
901	600/65-34/20													
4 wheels	600/65-34/24			Front, Rear										
	600/65R34					Front, Rear								
	700/55-34/20													
	710/55-34/24			Front, Rear										
	710/55R34					Front, Rear								
901	600/50-24.5/20		Front											







Machine	Tire size / PR	Tread pattern							Inflation pressure					
									Front		Rear		Max. inflation and track pressure	
		F2	TRS 2	TRS 2+	F *Nordman F	Rider	ELS	TRS *Nordman TRS	kPa	psi	kPa	psi	kPa	psi
6 wheels	650/45R24.5					Front			550	80			550	80
	710/40-24.5/20	Front	Front		Front			550	80			550	80	
	600/65-34/20						*Rear			320	46	360	52	
	600/65-34/24			Rear						320	46	400	58	
	600/65R34					Rear				320	46	400	58	
	700/55-34/20						*Rear			320	46	360	52	
	710/55-34/24			Rear						320	46	400	58	
	710/55R34					Rear				320	46	400	58	
901XC	600/50-24.5/20		Front, Rear					500	73	320	46	550	80	
8 wheels	710/40-24.5/20	Front, Rear	Front, Rear		Front, Rear			500	73	320	46	550	80	
	800/40-24.5/20	Front, Rear	Front, Rear					500	73	320	46	550	80	
911	600/65-34/20						*Front, Rear	320	46	320	46	360	52	
4 wheels	600/65-34/24			Front, Rear				320	46	320	46	400	58	
	600/65R34					Front, Rear		320	46	320	46	400	58	
	700/55-34/20						*Front, Rear	320	46	320	46	360	52	
	710/55-34/24			Front, Rear				320	46	320	46	400	58	
	710/55R34					Front, Rear		320	46	320	46	400	58	
911	600/55R26.5					Front		460	67			550	80	
6 wheels	600/55-26.5/20	Front	Front		Front, *Front		*Front	460	67			550	80	
	710/45R26.5					Front		460	67			550	80	







Machine	Tire size / PR	Tread pattern							Inflation pressure					
									Front		Rear		Max. inflation and track pressure	
		F2	TRS 2	TRS 2+	F *Nordman F	Rider	ELS	TRS *Nordman TRS	kPa	psi	kPa	psi	kPa	psi
	710/45-26.5/16				Front				460	67			460	67
	710/45-26.5/20	Front	Front		Front, *Front			*Front	460	67			550	80
	710/45-26.5/24	Front			Front				460	67			600	87
	800/40-26.5/20	Front	Front		Front				460	67			550	80
	600/65-34/20							*Rear			320	46	360	52
	600/65-34/24			Rear							320	46	400	58
	600/65R34					Rear					320	46	400	68
	700/55-34/20							*Rear			320	46	360	52
	710/55-34/24			Rear							320	46	400	58
	710/55R34					Rear					320	46	400	58
931	600/55R26.5					Front			500	73			550	80
6 wheels	600/55-26.5/20	Front	Front		Front, *Front			*Front	500	73			550	80
	710/45R26.5					Front			500	73			550	80
	710/45-26.5/20	Front	Front		Front, *Front			*Front	500	73			550	80
	710/45-26.5/24	Front			Front				500	73			600	87
	800/40-26.5/20	Front	Front		Front				500	73			550	80
	600/65-34/20							*Rear			320	46	360	52
	600/65-34/24			Rear							320	46	400	58
	600/65R34					Rear					320	46	400	58
	700/55-34/20							*Rear			320	46	360	52







Machine	Tire size / PR	Tread pattern							Inflation pressure					
									Front		Rear		Max. inflation and track pressure	
		F2	TRS 2	TRS 2+	F *Nordman F	Rider	ELS	TRS *Nordman TRS	kPa	psi	kPa	psi	kPa	psi
	710/55-34/24			Rear							320	46	400	58
	710/55R34					Rear					320	46	400	58
931XC	600/55-26.5/20	Front, Rear	Front, Rear		Front, Rear *Front, *Rear			*Front, *Rear	500	73	400	58	550	80
8 wheels	710/45-26.5/20	Front, Rear	Front, Rear		Front, Rear *Front, *Rear			*Front, *Rear	500	73	400	58	550	80
	710/45-26.5/24	Front, Rear	Front, Rear		Front, Rear				500	73	400	58	600	87
	800/40-26.5/20	Front, Rear	Front, Rear		Front, Rear				500	73	400	58	550	80
941	650/65-26.5/20						Front	Front	500	73			550	80
6 wheels	750/55-26.5/20				Front, *Front			Front, *Front	500	73			550	80
	750/55-26.5/24	Front	Front						500	73			600	87
	780/55-26.5/20				Front				500	73			550	80
	800/50R26.5					Front			500	73			550	80
	700/70-34/16							Rear			260	38	260	38
	700/70-34/20							*Rear			320	46	360	52
	710/70-34/24			Rear							320	46	400	58
	710/70R34					Rear					320	46	400	58
951XC	710/45-26.5/24	Front, Rear	Front, Rear						500	73	400	58	600	87
8 wheels	800/40-26.5/20	Front, Rear	Front, Rear						500	73	400	58	550	80
951	710/55-28.5/24	Front	Front						500	73			600	87
6 wheels	780/50-28.5/24	Front	Front						500	73			600	87







Machine	Tire size / PR	Tread pattern							Inflation pressure					
									Front		Rear		Max. inflation and track pressure	
		F2	TRS 2	TRS 2+	F *Nordman F	Rider	ELS	TRS *Nordman TRS	kPa	psi	kPa	psi	kPa	psi
	710/70-34/24			Rear							320	46	400	58
	710/70R34					Rear					320	46	400	58







KOMATSU FORWARDERS







Machine	Tire size / PR	Tread pattern							Inflation pressure					
									Front		Rear		Max. inflation and track pressure	
		F2	TRS 2	TRS 2+	F *Nordman F	Rider	ELS	TRS *Nordman TRS	kPa	psi	kPa	psi	kPa	psi
825TX	600/50-22.5/20	Front, Rear	Front, Rear				Front, Rear	Front, Rear	350	51	500	73	550	80
8 wheels	710/40-22.5/20	Front, Rear	Front, Rear		Front, Rear		Front, Rear	Front, Rear	350	51	500	73	550	80
830.3	600/50-22.5/16						Front, Rear	Front, Rear	350	51	430	62	430	62
8 wheels	600/50-22.5/20						Front, Rear	Front, Rear	350	51	500	73	550	80
	710/40-22.5/16				Front, Rear		Front, Rear	Front, Rear	350	51	400	58	400	58
840TX	600/50R24.5					Front, Rear			400	58	550	80	550	80
8 wheels	650/45R24.5					Front, Rear			400	58	550	80	550	80
	710/40-24.5/20	Front, Rear	Front, Rear		Front, Rear				350	51	550	80	550	80
835	600/50-24.5/20		Front, Rear						400	58	550	80	550	80
8 wheels	650/45R24.5					Front, Rear			400	58	550	80	550	80
	710/40-24.5/20	Front, Rear	Front, Rear		Front, Rear				350	51	550	80	550	80

Machine	Tire size / PR	Tread pattern							Inflation pressure					
									Front		Rear		Max. inflation and track pressure	
		F2	TRS 2	TRS 2+	F *Nordman F	Rider	ELS	TRS *Nordman TRS	kPa	psi	kPa	psi	kPa	psi
	800/40-24.5/20	Front, Rear	Front, Rear						350	51	550	80	550	80
840.4	600/55-26.5/20	Front, Rear	Front, Rear		Front, Rear, *Front, Rear			*Front, Rear	350	51	550	80	550	80
8 wheels	600/55R26.5					Front, Rear			350	51	550	80	550	80
	710/45R26.5					Front, Rear			350	51	500	73	550	80
	710/45-26.5/20	Front, Rear	Front, Rear		Front, Rear, *Front, Rear			*Front, Rear	350	51	500	73	550	80
	710/45-26.5/24	Front, Rear			Front, Rear				350	51	500	73	600	87
	800/40-26.5/20	Front, Rear	Front, Rear		Front, Rear				350	51	500	73	550	80
840.4	600/55-26.5/20	Rear	Rear		Rear, *Rear			*Rear			550	80	550	80
6 wheels	600/55R26.5					Rear					550	80	550	80
	710/45R26.5					Rear					500	73	550	80
	710/45-26.5/20	Rear	Rear		Rear, *Rear			*Rear			500	73	550	80
	710/45-26.5/24	Rear			Rear						500	73	600	87
	800/40-26.5/20	Rear	Rear		Rear						500	73	550	80
	600/65-34/20							*Front	350	51			360	52
	600/65-34/24			Front					350	51			400	58
	600/65R34					Front			350	51			400	58
	700/55-34/20							*Front	350	51			360	52
	710/55-34/24			Front					350	51			400	58
	710/55R34					Front			350	51			400	58





Machine	Tire size / PR	Tread pattern							Inflation pressure					
									Front		Rear		Max. inflation and track pressure	
		F2	TRS 2	TRS 2+	F *Nordman F	Rider	ELS	TRS *Nordman TRS	kPa	psi	kPa	psi	kPa	psi
845	600/55-26.5/20	Front, Rear	Front, Rear		Front, Rear, *Front, Rear			*Front, Rear	350	51	550	80	550	80
8 wheels	600/55R26.5					Front, Rear			350	51	550	80	550	80
	710/45R26.5					Front, Rear			350	51	500	73	550	80
	710/45-26.5/20	Front, Rear	Front, Rear		Front, Rear, *Front, Rear			*Front, Rear	350	51	500	73	550	80
	710/45-26.5/24	Front, Rear			Front, Rear				350	51	500	73	600	87
	800/40-26.5/20	Front, Rear	Front, Rear		Front, Rear				350	51	500	73	550	80
855.1 / 855.2	710/45R26.5					Front, Rear			400	58	550	80	550	80
8 wheels	710/45-26.5/20	Front, Rear	Front, Rear		Front, Rear, *Front, Rear			*Front, Rear	400	58	550	80	550	80
	710/45-26.5/24	Front, Rear			Front, Rear				400	58	550	80	600	87
	800/40-26.5/20	Front, Rear	Front, Rear		Front, Rear				400	58	550	80	550	80
855.1 / 855.2	710/45R26.5					Rear					550	80	550	80
6 wheels	710/45-26.5/20	Rear	Rear		Rear, *Rear			*Rear			550	80	550	80
	710/45-26.5/24	Rear			Rear						550	80	600	87
	800/40-26.5/20	Rear	Rear		Rear						550	80	550	80
	600/65-34/20							*Front	350	51			360	52
	600/65-34/24			Front					350	51			400	58
	600/65R34					Front			350	51			400	58
	700/55-34/20							*Front	350	51			360	52

Machine	Tire size / PR	Tread pattern							Inflation pressure					
									Front		Rear		Max. inflation and track pressure	
		F2	TRS 2	TRS 2+	F *Nordman F	Rider	ELS	TRS *Nordman TRS	kPa	psi	kPa	psi	kPa	psi
	710/55-34/24			Front					350	51			400	58
	710/55R34					Front			350	51			400	58
860.4	710/45-26.5/20	Front, Rear	Front, Rear		Front, Rear, *Front, Rear			*Front, Rear	400	58	550	80	550	80
8 wheels	710/45-26.5/24	Front, Rear			Front, Rear				400	58	550	80	600	87
	710/45R26.5					Front, Rear			400	58	550	80	550	80
	800/40-26.5/20	Front, Rear	Front, Rear		Front, Rear				400	58	550	80	550	80
860.4	710/45-26.5/20	Rear	Rear		Rear, *Rear			*Rear			550	80	550	80
6 wheels	710/45-26.5/24	Rear			Rear						600	87	600	87
	710/45R26.5					Rear					550	80	550	80
	800/40-26.5/20	Rear	Rear		Rear						550	80	550	80
	600/65-34/20							*Front	350	51			360	52
	600/65-34/24			Front					350	51			400	58
	600/65R34					Front			350	51			400	58
	700/55-34/20							*Front	350	51			360	52
	710/55-34/24			Front				*Front	350	51			400	58
	710/55R34					Front			350	51			400	58
865	710/45-26.5/20	Front, Rear	Front, Rear		Front, Rear, *Front, Rear			*Front, Rear	400	58	550	80	550	80
8 wheels	710/45-26.5/24	Front, Rear			Front, Rear				400	58	600	87	600	87
	710/45R26.5					Front, Rear			400	58	550	80	550	80







Machine	Tire size / PR	Tread pattern							Inflation pressure					
									Front		Rear		Max. inflation and track pressure	
		F2	TRS 2	TRS 2+	F *Nordman F	Rider	ELS	TRS *Nordman TRS	kPa	psi	kPa	psi	kPa	psi
	800/40-26.5/20	Front, Rear	Front, Rear		Front, Rear				400	58	550	80	550	80
865	710/45-26.5/20	Rear	Rear		Rear, *Rear			*Rear			550	80	550	80
6 wheels	710/45-26.5/24	Rear			Rear						600	87	600	87
	710/45R26.5					Rear					550	80	550	80
	800/40-26.5/20	Rear	Rear		Rear						550	80	550	80
	600/65-34/20							*Front	350	51			360	52
	600/65-34/24			Front					350	51			400	58
	600/65R34					Front			350	51			400	58
	700/55-34/20							*Front	350	51			360	52
	710/55-34/24			Front					350	51			400	58
	710/55R34					Front			350	51			400	58
875	710/45-26.5/20	Front, Rear	Front, Rear		Front, Rear				400	58	550	80	550	80
8 wheels	710/45-26.5/24	Front, Rear			Front, Rear				400	58	600	87	600	87
	800/40-26.5/20	Front, Rear	Front, Rear		Front, Rear				400	58	550	80	550	80
875	710/45-26.5/20	Rear	Rear		Rear						550	80	550	
6 wheels	710/45-26.5/24	Rear			Rear						600	87	600	
	800/40-26.5/20	Rear	Rear		Rear						550	80	550	
	700/55-34/20							*Front	350	51			360	
	710/55-34/24			Front					350	51			400	
	710/55R34					Front			350	51			400	







Machine	Tire size / PR	Tread pattern							Inflation pressure					
									Front		Rear		Max. inflation and track pressure	
		F2	TRS 2	TRS 2+	F *Nordman F	Rider	ELS	TRS *Nordman TRS	kPa	psi	kPa	psi	kPa	psi
890.3	750/55-26.5/20				Front, Rear			Front, Rear	450	65	550	80	550	80
8 wheels	750/55-26.5/24	Front, Rear	Front, Rear						450	65	600	87	600	87
	780/55-26.5/20				Front, Rear				450	65	550	80	550	80
	800/50R26.5					Front, Rear			450	65	550	80	550	80
890.3	750/55-26.5/20				Rear, *Rear			Rear, *Rear			550	80	550	80
6 wheels	750/55-26.5/24	Rear	Rear								600	87	600	87
	780/55-26.5/20				Rear						550	80	550	80
	800/50R26.5					Rear					550	80	550	80
	700/70-34/16							Front	260	38			260	38
	700/70-34/20							*Front	350	51			360	52
	710/70-34/24			Front					350	51			400	58
	710/70R34					Front			350	51			400	58
895, 8 wheels	780/50-28.5/24	Front, Rear	Front, Rear						450	65	600	87	600	87
895	780/50-28.5/24	Rear	Rear								600	87	600	87
6 wheels	710/70-34/24			Front					350	51			400	58
	710/70R34					Front			350	51			400	58







CAT FORWARDERS







Machine	Tire size / PR	Tread pattern				Inflation pressure							
						Front		Rear		With tracks		Max inflation and track pressure	
		F	Rider	ELS	TRS	kPa	psi	kPa	psi	kPa	psi	kPa	psi
584	750/55-26.5/20	Rear			Rear	400	58	550	80	550	80	550	80
6 wheels	780/55-26.5/20	Rear				400	58	550	80	550	80	550	80
	800/50R26.5		Rear			400	58	550	80	550	80	550	80
	700/70-34/16				Front	260	41			280	41	260	41
584 8	750/55-26.5/20	Front, Rear			Front, Rear	400	58	550	80	550	80	550	80
8 wheels	780/55-26.5/20	Front, Rear				400	58	550	80	550	80	550	80
	800/50R26.5		Front, Rear			400	58	550	80	550	80	550	80
584 HD	750/55-26.5/20	Front, Rear			Front, Rear	400	58	550	80	550	80	550	80
8 wheels	780/55-26.5/20	Front, Rear				400	58	550	80	550	80	550	80
	800/50R26.5		Front, Rear			400	58	550	80	550	80	550	80

JOHN DEERE HARVESTERS





Machine	Tire size / PR	Tread pattern							Inflation pressure						
									Front		Rear		Max inflation and track pressure		
		F2	TRS 2	TRS 2+	F *Nordman F	Rider	ELS	TRS *Nordman TRS	kPa	psi	kPa	psi	kPa	psi	
1070G	650/60-26.5/20							Front, Rear	Front, Rear	450	65	300	44	550	80
4 wheels	750/55-26.5/20				Front, Rear *Front, Rear				Front, Rear *Front, Rear	450	65	300	44	550	80
	750/55-26.5/24	Front, Rear	Front, Rear							450	65	300	44	600	87
	600/65-34/20								*Front, Rear	320	46	280	41	360	52
	600/65-34/24			Front, Rear						320	46	280	41	400	58
	600/65R34					Front, Rear				320	46	280	41	400	58
	700/55-34/20								*Front, Rear	320	46	280	41	360	52
	710/55-34/24			Front, Rear						320	46	280	41	400	58
	710/55R34					Front, Rear				320	46	280	41	400	58
1070G	600/50-22.5/16							Front		400	58			430	62
6 wheels	600/50-22.5/20	Front	Front							400	58			550	80
	710/40-22.5/16				Front					400	58			400	58
	710/40-22.5/20	Front	Front							400	58			550	80
	650/60-26.5/12								Rear			280	41	280	41
	650/60-26.5/20							Rear	Rear			300	44	550	80
	750/55-26.5/20	Rear			Rear, *Rear				Rear, *Rear			300	44	550	80
	600/65-34/20								*Rear			280	41	360	52
	600/65-34/24			Rear								280	41	400	58







Machine	Tire size / PR	Tread pattern							Inflation pressure					
									Front		Rear		Max inflation and track pressure	
		F2	TRS 2	TRS 2+	F *Nordman F	Rider	ELS	TRS *Nordman TRS	kPa	psi	kPa	psi	kPa	psi
	600/65R34										280	41	400	58
	700/55-34/20										280	41	360	52
	710/55-34/24			Rear							280	41	400	58
	710/55R34					Rear					280	41	400	58
1170G 24.5"	600/50-24.5/20		Front						450	65			550	80
6 wheels	650/45R24.5					Front			450	65			550	80
	710/40-24.5/20	Front	Front		Front, *Front				450	65			550	80
	800/40-24.5/20	Front	Front						450	65			550	80
	600/65-34/20										300	44	360	52
	600/65-34/24			Rear							300	44	400	58
	600/65R34					Rear					300	44	400	58
	700/55-34/20										300	44	360	52
	710/55-34/24			Rear							300	44	400	58
	710/55R34					Rear					300	44	400	58
1170G 24.5"	600/50-24.5		Front, Rear						450	65	400	58	550	80
8 wheels	650/45R24.5					Front			450	65	400	58	550	80
	710/40-24.5/20	Front, Rear	Front, Rear		Front, Rear *Front, Rear				450	65	400	58	550	80
	800/40-24.5/20	Front, Rear	Front, Rear						450	65	400	58	550	80
1170G 26.5"	600/55-26.5/20	Front	Front		Front, *Front				500	73			550	80









Machine	Tire size / PR	Tread pattern							Inflation pressure					
									Front		Rear		Max inflation and track pressure	
		F2	TRS 2	TRS 2+	F *Nordman F	Rider	ELS	TRS *Nordman TRS	kPa	psi	kPa	psi	kPa	psi
6 wheels	710/45-26.5/20	Front	Front		Front, *Front			*Front	500	73			550	80
	710/45-26.5/24	Front			Front				500	73			600	87
	800/40-26.5/20	Front	Front		Front				500	73			500	73
	600/65-34/20							*Rear			300	44	360	52
	600/65-34/24			Rear							300	44	400	58
	600/65R34					Rear					300	44	400	58
	700/55-34/20							*Rear			300	44	360	52
	710/55-34/24			Rear							300	44	400	58
	710/55R34					Rear					300	44	400	58
1270G	600/55-26.5/20	Front	Front		Front, *Front			*Front	500	73			550	80
6 wheels	600/55R26.5					Front		*Front	500	73			550	80
	710/45-26.5/20	Front	Front		Front, *Front			*Front	500	73			550	80
	710/45R26.5					Front		*Front	500	73			550	80
	710/45-26.5/24	Front			Front				500	73			600	87
	800/40-26.5/20	Front	Front		Front				500	73			500	73
	600/65-34/20							*Rear			300	44	360	52
	600/65-34/24			Rear							300	44	400	58
	600/65R34					Rear					300	44	400	58
	700/55-34/20							*Rear			300	44	360	52
710/55-34/24			Rear							300	44	400	58	









Machine	Tire size / PR	Tread pattern							Inflation pressure					
									Front		Rear		Max inflation and track pressure	
		F2	TRS 2	TRS 2+	F *Nordman F	Rider	ELS	TRS *Nordman TRS	kPa	psi	kPa	psi	kPa	psi
	710/55R34					Rear					300	44	400	58
1270G	600/55-26.5/20	Front.Rear	Front.Rear		Front.Rear *Front.Rear			*Front.Rear	500	73	400	58	550	80
6 wheels	600/55R26.5					Front.Rear			500	73	400	58	550	80
	710/45-26.5/20	Front.Rear	Front.Rear		Front.Rear *Front.Rear			*Front.Rear	500	73	400	58	550	80
	710/45R26.5					Front.Rear			500	73	400	58	550	80
	710/45-26.5/24	Front.Rear			Front.Rear				500	73	400	58	600	87
	800/40-26.5/20	Front.Rear	Front.Rear		Front.Rear				500	73	400	58	500	73
1470G	650/65-26.5/20						Front	Front	500	73			550	80
6 wheels	750/55-26.5/20				Front, *Front			Front, *Front	500	73			550	80
	750/55-26.5/24	Front	Front						500	73			600	87
	780/55-26.5/20				Front				500	73			600	87
	710/55-28.5/24	Front	Front		Front				500	73			600	87
	780/50-28.5/24	Front	Front						500	73			600	87
	700/70-34/16							Rear			260	38	260	38
	700/70-34/20							*Rear			300	44	360	52
	710/70-34/24			Rear							300	44	400	58
	710/70R34					Rear					300	44	400	58









JOHN DEERE FORWARDERS









Machine	Tire size / PR	Tread pattern						Inflation pressure					
								Front		Rear		Max inflation and track pressure	
		F2	TRS 2	TRS 2+	F *Nordman F	Rider	TRS *Nordman TRS	kPa	psi	kPa	psi	kPa	psi
810E	600/50-22.5/20	Front, Rear	Front, Rear				Front, Rear	300	44	500	73	550	80
8 wheels	710/40-22.5/16				Front, Rear		Front, Rear	300	44	400	58	400	58
	710/40-22.5/20	Front, Rear	Front, Rear					300	44	500	73	550	80
910G 22.5"	600/50-22.5/20	Front, Rear	Front, Rear				Front, Rear	300	44	500	73	550	80
8 wheels	710/40-22.5/16				Front, Rear		Front, Rear	300	44	400	58	400	58
	710/40-22.5/20	Front, Rear	Front, Rear					300	44	500	73	550	80
910/1010G 24.5"	600/50-24.5		Rear							550	80	550	80
6 wheels	650/45R24.5					Rear				550	80	550	80
	710/40-24.5/20	Rear	Rear		Rear					500	73	550	80
	800/40-24.5/20	Rear	Rear							500	73	550	80
	600/65-34/20						*Front	300	44			360	52
	600/65-34/24			Front				300	44			400	58
	600/65R34					Front		300	44			400	58
	700/55-34/20						*Front	300	44			360	52
	710/55-34/24			Front				300	44			400	58









Machine	Tire size / PR	Tread pattern						Inflation pressure					
								Front		Rear		Max inflation and track pressure	
		F2	TRS 2	TRS 2+	F *Nordman F	Rider	TRS *Nordman TRS	kPa	psi	kPa	psi	kPa	psi
	710/55R34					Front					400	58	
	28L-26/26						Front	300	44			420	61
910/1010G 24.5"	600/50-24.5												
8 wheels	650/45R24.5					Front, Rear		400	58	550	80	550	80
	710/40-24.5/20	Front, Rear	Front, Rear		Front, Rear* Front, Rear			400	58	500	73	550	80
	800/40-24.5/20	Front, Rear	Front, Rear					400	58	500	73	550	80
1010G 26.5"	600/55-26.5/20	Front, Rear	Front, Rear		Front, Rear* Front, Rear		*Front, Rear	400	58	550	80	550	80
8 wheels	600/55R26.5					Front, Rear		400	58	550	80	550	80
	710/45-26.5/20	Front, Rear	Front, Rear		Front, Rear* Front, Rear		Front, Rear *Front, Rear	400	58	500	73	550	80
	710/45-26.5/24	Front, Rear			Front, Rear			400	58	500	73	600	87
	710/45R26.5					Front, Rear		400	58	500	73	550	80
	800/40-26.5/20	Front, Rear	Front, Rear		Front, Rear			400	58	500	73	500	74
1010G 26.5"	600/55-26.5/20	Rear	Rear		Rear, *Rear		*Rear			550	80	550	80
6 wheels	600/55R26.5					Rear				550	80	550	80
	710/45-26.5/20	Rear	Rear		Rear, *Rear		*Rear			500	73	550	80

Machine	Tire size / PR	Tread pattern						Inflation pressure					
												Max inflation and track pressure	
		F2	TRS 2	TRS 2+	F *Nordman F	Rider	TRS *Nordman TRS	kPa	psi	kPa	psi	kPa	psi
	710/45-26.5/24	Rear			Rear					500	73	550	80
	710/45R26.5					Rear				500	73	550	80
	800/40-26.5/20	Rear	Rear		Rear					500	73	500	73
	600/65-34/20						*Front	300	44			360	52
	600/65-34/24			Front				300	44			400	58
	600/65R34				Front			300	44			400	58
	700/55-34/20						*Front	300	44			360	52
	710/55-34/24			Front				300	44			400	58
	710/55R34				Front			300	44			400	58
	28L-26/26						Front	300	44			420	61
1110G	600/55-26.5/20	Front, Rear	Front, Rear		Front, Rear *Front, Rear		*Front, Rear	400	58	550	80	550	80
8 wheels	600/55R26.5					Front, Rear		400	58	550	80	550	80
	710/45-26.5/20	Front, Rear	Front, Rear		Front, Rear *Front, Rear		Front, Rear *Front, Rear	400	58	500	73	550	80
	710/45-26.5/24	Front, Rear			Front, Rear			400	58	500	73	600	87
	710/45R26.5					Front, Rear		400	58	500	73	550	80
	800/40-26.5/20	Front, Rear	Front, Rear		Front, Rear			400	58	500	73	500	73







Machine	Tire size / PR	Tread pattern						Inflation pressure					
												Max inflation and track pressure	
		F2	TRS 2	TRS 2+	F *Nordman F	Rider	TRS *Nordman TRS	Front kPa	psi	Rear kPa	psi	kPa	psi
1110G	600/55-26.5/20	Rear	Rear		Rear, *Rear		*Rear			550	80	550	80
6 wheels	600/55R26.5					Rear				550	80	550	80
	710/45-26.5/20	Rear	Rear		Rear, *Rear		*Rear			500	73	550	80
	710/45-26.5/24	Rear			Rear					500	73	550	80
	710/45R26.5					Rear				500	73	550	80
	800/40-26.5/20	Rear	Rear		Rear					500	73	500	73
	600/65-34/20						*Front	300	44			360	52
	600/65-34/24			Front				300	44			400	58
	600/65R34					Front		300	44			400	58
	700/55-34/20						*Front	300	44			360	52
	710/55-34/24			Front				300	44			400	58
	710/55R34					Front		300	44			400	58
	28L-26/26						Front	300	44			420	61
1210G	600/55-26.5/20	Front, Rear	Front, Rear		Front, Rear *Front, Rear		*Front, Rear	400	58	550	80	550	80
8 wheels	600/55R26.5					Front, Rear		400	58	550	80	550	80
	710/45-26.5/20	Front, Rear	Front, Rear		Front, Rear *Front, Rear		*Front, Rear	400	58	500	73	550	80







Machine	Tire size / PR	Tread pattern						Inflation pressure						
												Max inflation and track pressure		
		F2	TRS 2	TRS 2+	F *Nordman F	Rider	TRS *Nordman TRS	kPa	psi	kPa	psi	kPa	psi	
	710/45-26.5/24	Front, Rear			Front, Rear									
	710/45R26.5					Front, Rear								
	800/40-26.5/20	Front, Rear	Front, Rear		Front, Rear									
1210G	600/55-26.5/20	Rear	Rear		Rear, *Rear					550	80	550	80	
6 wheels	600/55R26.5					Rear				550	80	550	80	
	710/45-26.5/20	Rear	Rear		Rear, *Rear					500	73	550	80	
	710/45-26.5/24	Rear			Rear					500	73	600	87	
	710/45R26.5					Rear				500	73	550	80	
	800/40-26.5/20	Rear	Rear		Rear					500	73	550	80	
	600/65-34/20													
	600/65-34/24			Front						300	44			400
	600/65R34					Front				300	44			400
	700/55-34/20													
	710/55-34/24			Front						300	44			400
	710/55R34					Front				300	44			400
	28L-26/26													
										300	44			420







Machine	Tire size / PR	Tread pattern						Inflation pressure					
												Max inflation and track pressure	
		F2	TRS 2	TRS 2+	F *Nordman F	Rider	TRS *Nordman TRS	Front kPa	psi	Rear kPa	psi	kPa	psi
1510G	710/45-26.5/20	Front, Rear	Front, Rear		Front, Rear								
8 wheels	710/45-26.5/24	Front, Rear			Front, Rear		400	58	600	87	600	87	
	710/45R26.5					Front, Rear	400	58	550	80	550	80	
	800/40-26.5/20	Front, Rear	Front, Rear		Front, Rear		400	58	550	80	550	80	
1510G	710/45-26.5/20	Rear	Rear		Rear				550	80	550	80	
6 wheels	710/45-26.5/24	Rear			Rear				600	87	600	87	
	710/45R26.5					Rear			550	80	550	80	
	800/40-26.5/20		Rear		Rear				500	73	500	73	
	600/65-34/20						*Front	320	46			360	52
	600/65-34/24			Front				320	46			400	58
	600/65R34					Front		320	46			400	58
	700/55-34/20						*Front	320	46			360	52
	710/55-34/24			Front				320	46			400	58
	710/55R34					Front		320	46			400	58
1910G	750/55-26.5/20				Front, Rear *Front, Rear					550	80	550	80
8 wheels	750/55-26.5/24	Front, Rear	Front, Rear					450	65	600	87	600	87

Machine	Tire size / PR	Tread pattern						Inflation pressure					
												Max inflation and track pressure	
		F2	TRS 2	TRS 2+	F *Nordman F	Rider	TRS *Nordman TRS	kPa	psi	kPa	psi	kPa	psi
	780/55-26.5/20				Front, Rear			450	65	600	87	600	87
	800/50R26.5					Front, Rear		450	65	550	80	550	80
	710/55-28.5/24	Front, Rear	Front, Rear					500	65	600	87	600	87
	780/50-28.5/24	Front, Rear	Front, Rear					450	65	600	87	600	87
1910G	750/55-26.5/20				Rear, *Rear					550	80	550	80
6 wheels	750/55-26.5/24	Rear	Rear							600	87	600	87
	780/55-26.5/20				Rear					600	87	600	87
	800/50R26.5					Rear				550	80	550	80
	710/55-28.5/24	Rear	Rear							600	87	600	87
	780/50-28.5/24	Rear	Rear							600	87	600	87
	700/70-34/20						*Front	340	49			360	52
	710/70-34/24			Front				340	49			400	58
	710/70R34					Front		340	49			400	58







LOGSET HARVESTERS







Machine	Tire size / PR	Tread pattern							Inflation pressure						
									Front		Rear		Max inflation and track pressure		
		F2	F	Nordman F	TRS 2	Rider	TRS	Nordman TRS	kPa	psi	kPa	psi	kPa	psi	
4H	650/60-26.5/12							Front, Rear		240	35	240	41	280	41
4 wheels	750/55-26.5/20		Front, Rear	Front, Rear				Front, Rear	Front, Rear	280	41	280	41	550	80
	750/55-26.5/24	Front, Rear			Front, Rear					280	41	280	41	550	80
	780/55-26.5/20		Front, Rear							280	41	280	41	550	80
	600/65-34/20						Front, Rear			280	41	280	41	360	52
	600/65R34					Front, Rear				280	41	280	41	400	58
	700/55-34/20						Front, Rear			260	38	280	41	360	52
	710/55R34					Front, Rear				260	38	280	41	400	58
5H	600/50-22.5/20							Front		430	62			550	80
6 wheels	710/40-22.5/16		Front							400	58			430	62
	710/40-22.5/20	Front	Front			Rear				400	58			550	80
	600/65-34/20							Rear				280	41	360	52
	600/65R34					Rear						280	41	400	58
	700/55-34/20							Rear				280	41	360	52
	710/55R34					Rear						280	41	400	58
6H	600/55-26.5/20	Front	Front	Front	Front			Front		550	80			550	80
6 wheels	600/55R26.5							Front		550	80			550	80
	710/45-26.5/20	Front	Front	Front	Front			Front		550	80			550	80
	710/45R26.5							Front		550	80			550	80

Machine	Tire size / PR	Tread pattern							Inflation pressure					
									Front		Rear		Max inflation and track pressure	
		F2	F	Nordman F	TRS 2	Rider	TRS	Nordman TRS	kPa	psi	kPa	psi	kPa	psi
	800/40-26.5/20	Front	Front		Front				550	80			550	80
	600/65-34/20							Rear			280	41	360	52
	600/65R34					Rear					280	41	400	58
	700/55-34/20							Rear			280	41	360	52
	710/55R34					Rear					280	41	400	58
8H	600/55-26.5/20	Front	Front	Front	Front			Front	550	80			550	80
6 wheels	600/55R26.5					Front			550	80			550	80
	710/45-26.5/20	Front	Front	Front	Front			Front	550	80			550	80
	710/45R26.5								550	80			550	80
	800/40-26.5/20	Front	Front		Front				550	80			550	80
	600/65-34/20							Rear			280	41	360	52
	600/65R34					Rear					280	41	400	58
	700/55-34/20							Rear			280	41	360	52
	710/55R34					Rear					280	41	400	58
10H	750/55-26.5/20		Front	Front			Front	Front	500	73			550	80
6 wheels	750/55-26.5/24	Front			Front				500	73			550	80
	780/55-26.5/20		Front						500	73			550	80
	710/55-28.5/24	Front			Front				500	73			600	87
	780/50-28.5/24	Front			Front				500	73			600	87
	700/70-34/16						Rear				260	38	260	38







Machine	Tire size / PR	Tread pattern							Inflation pressure					
									Front		Rear		Max inflation and track pressure	
		F2	F	Nordman F	TRS 2	Rider	TRS	Nordman TRS	kPa	psi	kPa	psi	kPa	psi
	700/70-34/20										300	44	360	52
	710/70R34					Rear					300	44	400	58







LOGSET FORWARDERS







Machine	Tire size / PR	Tread pattern							Inflation pressure					
									Front		Rear		Max inflation and track pressure	
		F2	F	Nordman F	TRS 2	Rider	TRS	Nordman TRS	kPa	psi	kPa	psi	kPa	psi
4F	600/50-22.5/20							Front, Rear	350	51	500	73	550	80
8 wheels	710/40-22.5/16		Front, Rear						350	51	430	62	430	62
	710/40-22.5/20	Front, Rear			Front, Rear				350	51	430	62	430	62
5F	600/55-26.5/20	Front, Rear	Front, Rear	Front, Rear	Front, Rear			Front, Rear	350	51	550	80	550	80
8 wheels	600/55R26.5					Front, Rear			350	51	550	80	550	80
	710/45-26.5/16		Front, Rear						350	51	460	67	460	67
	710/45-26.5/20	Front, Rear	Front, Rear	Front, Rear	Front, Rear			Front, Rear	350	51	500	73	550	80
	710/45R26.5					Front, Rear			350	51	500	73	550	80
	800/40-26.5/20	Front, Rear	Front, Rear		Front, Rear				350	51	500	73	550	80
6F	600/55-26.5/20	Front, Rear	Front, Rear	Front, Rear	Front, Rear			Front, Rear	350	51	550	80	550	80
8 wheels	600/55R26.5					Front, Rear			350	51	550	80	550	80
	710/45-26.5/20	Front, Rear	Front, Rear	Front, Rear	Front, Rear			Front, Rear	350	51	550	80	550	80





Machine	Tire size / PR	Tread pattern							Inflation pressure					
									Front		Rear		Max inflation and track pressure	
		F2	F	Nordman F	TRS 2	Rider	TRS	Nordman TRS	kPa	psi	kPa	psi	kPa	psi
	710/45R26.5					Front, Rear			350	51	550	80	550	80
	800/40-26.5/20	Front, Rear	Front, Rear		Front, Rear			350	51	500	73	550	80	
8F	710/45-26.5/20	Front, Rear	Front, Rear	Front, Rear	Front, Rear			400	58	550	80	550	80	
8 wheels	710/45-26.5/24	Front, Rear				Front, Rear		400	58	550	80	600	87	
	710/45R26.5					Front, Rear		400	58	550	80	550	80	
	800/40-26.5/20	Front, Rear	Front, Rear		Front, Rear			400	58	500	73	550	80	
10F	750/55-26.5/20		Front, Rear	Front, Rear			Front, Rear	400	58	550	80	550	80	
8 wheels	750/55-26.5/24	Front, Rear			Front, Rear			400	58	550	80	600	87	
	780/55-26.5/20		Front, Rear					400	58	550	80	550	80	
	780/50-28.5/24	Front, Rear			Front, Rear			400	58	600	87	600	87	
12F - 8 wheels	780/50-28.5/24	Front, Rear			Front, Rear			450	58	600	87	600	87	







PONSSE HARVESTERS

Machine	Tire size / PR	Tread pattern							Inflation pressure					
									Front		Rear		Max inflation and track pressure	
		F2	TRS 2	TRS 2+	*Nordman F	Rider	ELS	*Nordman TRS	kPa	psi	kPa	psi	kPa	psi
Beaver	600/55-26.5/20	Front, Rear	Front, Rear		Front, Rear *Front, Rear			*Front, Rear	380	55	460	67	550	80
6 wheels	600/55R26.5					Front, Rear			380	55	460	67	550	80







Machine	Tire size / PR	Tread pattern							Inflation pressure					
									Front		Rear		Max inflation and track pressure	
		F2	TRS 2	TRS 2+	F *Nordman F	Rider	ELS	TRS *Nordman TRS	kPa	psi	kPa	psi	kPa	psi
	710/45-26.5/16				Front, Rear				350	51	460	67	460	67
	710/45-26.5/20	Front, Rear	Front, Rear		Front, Rear *Front, Rear			*Front, Rear	350	51	460	67	550	80
	710/45R26.5					Front, Rear			350	51	460	67	550	80
	800/40-26.5/20	Front, Rear	Front, Rear		Front, Rear				350	51	460	67	550	80
	650/65-26.5/20						Front	Front	350	51	460	67	550	80
	750/55-26.5/20	Front	Front		Front				350	51	460	67	550	80
Fox	600/55-26.5/20	Front, Rear	Front, Rear		Front, Rear *Front, Rear			*Front, Rear	400	58	460	67	550	80
8 wheels	600/55R26.5					Front, Rear			400	58	460	67	550	80
	710/45-26.5/16				Front, Rear				400	58	460	67	460	67
	710/45-26.5/20	Front, Rear	Front, Rear		Front, Rear *Front, Rear			*Front, Rear	400	58	460	67	550	80
	710/45R26.5					Front, Rear			400	58	460	67	550	80
	800/40-26.5	Front, Rear	Front, Rear		Front, Rear				400	58	460	67	550	80
Scorpion	600/55-26.5/20	Front, Rear	Front, Rear		Front, Rear *Front, Rear			*Front, Rear	450	65	450	65	550	80
Scorpion King	600/55R26.5					Front, Rear			450	65	450	65	550	80
8 wheels	710/45-26.5/16				Front, Rear				450	65	450	65	460	67
	710/45-26.5/20	Front, Rear	Front, Rear		Front, Rear *Front, Rear			*Front, Rear	450	65	450	65	550	80
	710/45R26.5					Front, Rear			450	65	450	65	550	80







Machine	Tire size / PR	Tread pattern							Inflation pressure					
									Front		Rear		Max inflation and track pressure	
		F2	TRS 2	TRS 2+	F *Nordman F	Rider	ELS	TRS *Nordman TRS	kPa	psi	kPa	psi	kPa	psi
	800/40-26.5	Front, Rear	Front, Rear		Front, Rear				450	65	450	65	550	80
Cobra	600/55-26.5/20	Front, Rear	Front, Rear		Front, Rear *Front, Rear			*Front, Rear	350	51	460	67	550	80
8 wheels	600/55R26.5					Front, Rear			350	51	460	67	550	80
	710/45-26.5/16				Front, Rear				350	51	460	67	460	67
	710/45-26.5/20	Front, Rear	Front, Rear		Front, Rear *Front, Rear			*Front, Rear	350	51	460	67	550	80
	710/45R26.5					Front, Rear			350	51	460	67	550	80
	800/40-26.5	Front, Rear	Front, Rear		Front, Rear				350	51	460	67	550	80
Ergo	600/55-26.5/20	Rear			Rear, *Rear			*Rear			460	67	550	80
6 wheels	600/55R26.5					Rear					460	67	550	80
	710/45-26.5/16				Rear						460	67	460	67
	710/45-26.5/20	Rear			Rear, *Rear			*Rear			460	67	550	80
	710/45R26.5					Rear					460	67	550	80
	800/40-26.5/20	Rear	Rear		Rear						460	67	550	80
	600/65-34/20							*Front	300	44			360	52
	600/65-34/24			Front					300	44			400	58
	600/65R34					Front			300	44			400	58
	700/55-34/20							*Front	300	44			360	52
	710/55-34/24			Front					300	44			400	58
	710/55R34					Front			300	44			400	58







Machine	Tire size / PR	Tread pattern							Inflation pressure					
									Front		Rear		Max inflation and track pressure	
		F2	TRS 2	TRS 2+	F *Nordman F	Rider	ELS	TRS *Nordman TRS	kPa	psi	kPa	psi	kPa	psi
Ergo	600/55-26.5/20	Front, Rear	Front, Rear		Front, Rear *Front, Rear			*Front, Rear	350	51	460	67	550	80
8 wheels	600/55R26.5					Front, Rear			350	51	460	67	550	80
	710/45-26.5/16				Front, Rear				350	51	460	67	460	67
	710/45-26.5/20	Front, Rear	Front, Rear		Front, Rear *Front, Rear			*Front, Rear	350	51	460	67	550	80
	710/45R26.5					Front, Rear			350	51	460	67	550	80
	800/40-26.5	Front, Rear	Front, Rear		Front, Rear				350	51	460	67	550	80
Bear	650/65-26.5/20						Front, Rear	Front, Rear	400	58	460	67	550	80
8 wheels	750/55-26.5/20				Front, Rear *Front, Rear			Front, Rear *Front, Rear	400	58	460	67	550	80
	750/55-26.5/24	Front, Rear	Front, Rear						400	58	460	67	600	87
	780/55-26.5/20				Front, Rear				400	58	460	67	550	80
	800/50R26.5					Front, Rear			400	58	460	67	550	80
	710/55-28.5/24	Front, Rear	Front, Rear						400	58	460	67	600	87
	780/50-28.5/24	Front, Rear	Front, Rear						400	58	460	67	600	87
Bear	650/65-26.5/20						Rear	Rear			460	67	550	80
8 wheels	750/55-26.5/20				Rear, *Rear			Rear, *Rear			460	67	550	80
	750/55-26.5/24	Rear	Rear								460	67	600	87
	780/55-26.5/20				Rear						460	67	550	80
	710/55-28.5/24	Rear	Rear								460	67	600	87







Machine	Tire size / PR	Tread pattern							Inflation pressure					
									Front		Rear		Max inflation and track pressure	
		F2	TRS 2	TRS 2+	F *Nordman F	Rider	ELS	TRS *Nordman TRS	kPa	psi	kPa	psi	kPa	psi
	780/50-28.5/24	Rear	Rear								460	67	600	87
	800/50R26.5					Rear					460	67	550	80
	700/70-34/16							Front	260	38			260	38
	700/70-34/20							Front	300	44			360	52
	710/70-34/24			Front					300	44			400	58
	710/70R34					Front			300	44			400	58







PONSSE FORWARDERS

Machine	Tire size / PR	Tread pattern						Inflation pressure					
								Front		Rear		Max inflation and track pressure	
		F2	TRS 2	TRS 2+	F *Nordman F	Rider	TRS *Nordman TRS	kPa	psi	kPa	psi	kPa	psi
Gazelle	600/50-22.5/20	Front, Rear	Front, Rear				Front, Rear	350	51	500	73	550	80
8 wheels	710/40-22.5/16				Front, Rear		Front, Rear	350	51	430	62	430	62
	710/40-22.5/20	Front, Rear	Front, Rear					350	51	430	62	550	80
Wisent / Dual	600/55-26.5/20	Front, Rear	Front, Rear		Front, Rear *Front, Rear		*Front, Rear	350	51	550	80	550	80
8 wheels	600/55R26.5					Front, Rear		350	51	550	80	550	80
	710/45-26.5/16				Front, Rear			350	51	460	67	460	67

Machine	Tire size / PR	Tread pattern						Inflation pressure					
								Front		Rear		Max inflation and track pressure	
		F2	TRS 2	TRS 2+	F *Nordman F	Rider	TRS *Nordman TRS	kPa	psi	kPa	psi	kPa	psi
	710/45-26.5/20	Front, Rear	Front, Rear		Front, Rear *Front, Rear		*Front, Rear	350	51	500	73	550	80
	710/45R26.5					Front, Rear		350	51	500	73	550	80
	800/40-26.5/20	Front, Rear	Front, Rear		Front, Rear			350	51	500	73	500	73
Wisent / Dual	600/55-26.5/20	Rear	Rear		Rear, *Rear		*Rear			550	80	550	80
6 wheels	600/55R26.5					Rear				550	80	550	80
	710/45-26.5/16				Rear					460	67	460	67
	710/45-26.5/20	Rear	Rear		Rear, *Rear		*Rear			500	73	550	80
	710/45R26.5					Rear				500	73	550	80
	800/40-26.5/20	Rear	Rear		Rear					500	73	550	80
	600/65-34/20						*Front	300	44			360	52
	600/65-34/24			Front				300	44			400	58
	600/65R34					Front		300	44			400	58
	700/55-34/20						*Front	300	44			360	52
	710/55-34/24			Front				300	44			400	58
	710/55R34					Front		300	44			400	58
Elk	600/55-26.5/20	Front, Rear	Front, Rear		Front, Rear *Front, Rear		*Front, Rear	350	51	550	80	550	80
8 wheels	600/55R26.5					Front, Rear		350	51	550	80	550	80
	710/45-26.5/20	Front, Rear	Front, Rear		Front, Rear *Front, Rear		*Front, Rear	350	51	500	73	550	80







Machine	Tire size / PR	Tread pattern						Inflation pressure					
								Front		Rear		Max inflation and track pressure	
		F2	TRS 2	TRS 2+	F *Nordman F	Rider	TRS *Nordman TRS	kPa	psi	kPa	psi	kPa	psi
	710/45-26.5/24	Front, Rear			Front, Rear			350	51	500	73	600	87
	710/45R26.5					Front, Rear		350	51	500	73	550	80
	800/40-26.5/20	Front, Rear	Front, Rear		Front, Rear			350	51	500	73	550	80
Elk	600/55-26.5/20	Rear	Rear		Rear, *Rear		*Rear			550	80	550	80
6 wheels	600/55R26.5					Rear				550	80	550	80
	710/45-26.5/20	Rear	Rear		Rear, *Rear		*Rear			500	73	550	80
	710/45-26.5/24	Rear			Rear					500	73	600	87
	710/45R26.5					Rear				500	73	550	80
	800/40-26.5/20	Rear	Rear		Rear					500	73	550	80
	600/65-34/20						*Front	320	46			360	52
	600/65-34/24			Front				320	46			400	58
	600/65R34					Front		320	46			400	58
	700/55-34/20						*Front	320	46			360	52
	710/55-34/24			Front				320	46			400	58
	710/55R34					Front		320	46			400	58
Bison	710/45-26.5/20	Front, Rear	Front, Rear		Front, Rear *Front, Rear		*Front, Rear	400	58	550	80	550	80
8 wheels	710/45-26.5/24	Front, Rear	Front, Rear		Front, Rear			400	58	550	80	600	87
	710/45R26.5					Front, Rear		400	58	550	80	550	80
	800/40-26.5/20	Front, Rear	Front, Rear		Front, Rear			400	58	550	80	550	80







Machine	Tire size / PR	Tread pattern						Inflation pressure					
								Front		Rear		Max inflation and track pressure	
		F2	TRS 2	TRS 2+	F *Nordman F	Rider	TRS *Nordman TRS	kPa	psi	kPa	psi	kPa	psi
Buffalo / Dual	710/45-26.5/20	Front, Rear	Front, Rear		Front, Rear *Front, Rear		*Front, Rear	400	58	550	80	550	80
8 wheels	710/45-26.5/24	Front, Rear	Front, Rear		Front, Rear			400	58	550	80	600	87
	710/45R26.5					Front, Rear		400	58	550	80	550	80
	800/40-26.5/20	Front, Rear	Front, Rear		Front, Rear			400	58	550	80	550	80
Buffalo / Dual / ADS	710/45-26.5/20	Rear	Rear		Rear, *Rear		*Rear			550	80	550	80
6 wheels	710/45-26.5/24	Rear	Rear		Rear					550	80	600	87
	710/45R26.5					Rear				550	80	550	80
	800/40-26.5/20	Rear	Rear		Rear					550	80	550	80
	600/65-34/20						*Front	320	46			360	52
	600/65-34/24			Front				320	46			400	58
	600/65R34					Front		320	46			400	58
	700/55-34/20						*Front	320	46			360	52
	710/55-34/24			Front				320	46			400	58
	710/55R34					Front		320	46			400	58
Buffalo King	600/55-26.5/20	Front	Front		Front, *Front		*Front	400	58			550	80
8 wheels	600/55R26.5					Front		400	58			550	80
	710/45-26.5/20	Front	Front		Front, *Front		*Front	400	58			550	80
	710/45-26.5/24	Front	Front		Front			400	58			600	87
	710/45R26.5					Front		400	58			550	80







Machine	Tire size / PR	Tread pattern						Inflation pressure					
								Front		Rear		Max inflation and track pressure	
		F2	TRS 2	TRS 2+	F *Nordman F	Rider	TRS *Nordman TRS	kPa	psi	kPa	psi	kPa	psi
	800/40-26.5/20	Front	Front		Front			400	58			550	80
	750/55-26.5/20				Rear, *Rear					550	80	550	80
	750/55-26.5/24	Rear	Rear							550	80	600	87
	780/55-26.5/20				Rear					550	80	550	80
	800/50R26.5					Rear				550	80	550	80
Buffalo King	750/55-26.5/20				Rear, *Rear					500	73	550	80
6 wheels	750/55-26.5/24	Rear	Rear							500	73	600	87
	780/55-26.5/20				Rear					500	73	550	80
	800/50R26.5					Rear				500	73	550	80
	700/70-34/16						Front	260	38			260	38
	700/70-34/20						*Front	300	44			360	52
	710/70-34/24			Front				300	44			400	58
	710/70R34					Front		300	44			400	58
Elephant	750/55-26.5/20				Front, Rear *Front, Rear		Front, Rear *Front, Rear	450	65	550	80	550	80
8 wheels	750/55-26.5/24	Front, Rear	Front, Rear					450	65	600	87	600	87
	780/55-26.5/20				Front, Rear			450	65	550	80	550	80
	780/50-28.5/24	Front, Rear	Front, Rear					450	65	600	87	600	87
	800/50R26.5					Front, Rear		450	65	550	80	550	80
Elephant	750/55-26.5/20				Rear, *Rear		Rear, *Rear			550	80	550	80

Machine	Tire size / PR	Tread pattern						Inflation pressure					
								Front		Rear		Max inflation and track pressure	
		F2	TRS 2	TRS 2+	F *Nordman F	Rider	TRS *Nordman TRS	kPa	psi	kPa	psi	kPa	psi
6 wheels	750/55-26.5/24	Rear	Rear							600	87	600	87
	780/55-26.5/20				Rear					550	80	550	80
	800/50R26.5					Rear				550	80	550	80
	780/50-28.5/24	Rear	Rear							600	87	600	87
	700/70-34/16						Front	260	38			260	38
	700/70-34/20						*Front	320	46			360	52
	710/70-34/24			Front				320	46			400	58
	710/70R34					Front		320	46			400	58
Elephant King	750/55-26.5/20				Front, Rear *Front, Rear		Front, Rear *Front, Rear	450	65	550	80	550	80
8 wheels	750/55-26.5/24	Front, Rear	Front, Rear					450	65	600	87	600	87
	780/55-26.5/20				Front, Rear			450	65	550	80	550	80
	780/50-28.5/24	Front, Rear	Front, Rear					450	65	600	87	600	87
	800/50R26.5					Front, Rear		450	65	550	80	550	80







ROTTNE HARVESTERS







Machine	Tire size / PR	Tread pattern						Inflation pressure					
								Front		Rear		Max inflation and track pressure	
		F2	TRS 2	TRS 2+	F *Nordman F	Rider	TRS *Nordman TRS	kPa	psi	kPa	psi	kPa	psi
H8	600/55-26.5/20	Front, Rear	Front, Rear		Front, Rear *Front, Rear		*Front, Rear	450	65	450	65	550	80
4 wheels	600/55R26.5					Front, Rear		450	65	450	65	550	80
	710/45-26.5/20	Front, Rear	Front, Rear		Front, Rear *Front, Rear		*Front, Rear	450	65	450	65	550	80
	710/45R26.5					Front, Rear		450	65	450	65	550	80
	800/40-26.5/20	Front, Rear	Front, Rear		Front, Rear			450	65	450	65	550	80
H11	600/50R24.5					Front		500	73			550	80
6 wheels	650/45R24.5					Front		500	73			550	80
	710/40-24.5	Front	Front		Front, *Front			500	73			550	80
	800/40-24.5/20	Front	Front					500	73			550	80
	600/65-34/20						*Rear			280	41	360	52
	600/65-34/24			Rear						280	41	400	58
	600/65R34					Rear				280	41	400	58
	700/55-34/20						*Rear			280	41	360	52
	710/55-34/24			Rear						280	41	400	58
	710/55R34					Rear				280	41	400	58
H11c	600/50R24.5					Front, Rear		500	73	450	65	550	80
8 wheels	650/45R24.5					Front, Rear		500	73	450	65	550	80

Machine	Tire size / PR	Tread pattern						Inflation pressure					
								Front		Rear		Max inflation and track pressure	
		F2	TRS 2	TRS 2+	F *Nordman F	Rider	TRS *Nordman TRS	kPa	psi	kPa	psi	kPa	psi
	710/40-24.5	Front, Rear	Front, Rear		Front, Rear *Front, Rear			500	73	450	65	550	80
H14c	600/55-26.5/20	Front	Front		Front, *Front			500	73			550	80
6 wheels	600/55R26.5					Front		500	73			550	80
	710/45-26.5/20	Front	Front		Front, *Front			500	73			550	80
	710/45R26.5					Front		500	73			550	80
	800/40-26.5/20	Front	Front		Front			500	73			550	80
	600/65-34/20									280	41	360	52
	600/65-34/24			Rear						280	41	400	58
	600/65R34					Rear				280	41	400	58
	700/55-34/20									280	41	360	52
	710/55-34/24			Rear						280	41	400	58
	710/55R34					Rear				280	41	400	58
H20b	750/55-26.5/20				Front, *Front			500	73			550	80
6 wheels	750/55-26.5/24	Front	Front					500	73			550	80
	780/55-26.5/20				Front			500	73			550	80
	700/70-34/16									260	38	260	38
	700/70-34/20									300	44	360	52
	710/70-34/24			Rear						300	44	400	58
	710/70R34					Rear				300	44	400	58

Machine	Tire size / PR	Tread pattern						Inflation pressure						
								Front		Rear		Max inflation and track pressure		
		F2	TRS 2	TRS 2+	F *Nordman F	Rider	TRS *Nordman TRS	kPa	psi	kPa	psi	kPa	psi	
H21d	750/55-26.5/20				Front, Rear *Front, Rear			*Front, Rear	500	73	450	65	550	80
8 wheels	750/55-26.5/24	Front, Rear	Front, Rear						500	73	450	65	600	87
	780/55-26.5/20				Front				500	73	450	65	550	80
H21d	750/55-26.5/20				Front, Rear *Front, Rear			*Front, Rear	500	73	450	65	550	80
6 wheels	750/55-26.5/24	Front, Rear	Front, Rear						500	73	450	65	600	87
	780/55-26.5/20				Front				500	73	450	65	550	80
	700/70-34/16							Rear			260	38	260	38
	700/70-34/20							*Rear			300	44	360	52
	710/70-34/24			Rear							300	44	400	58
	710/70R34					Rear					300	44	400	58





ROTTNE FORWARDERS





Machine	Tire size / PR	Tread pattern						Inflation pressure						
								Front		Rear		Max inflation and track pressure		
		F2	TRS 2	TRS 2+	F *Nordman F	Rider	TRS *Nordman TRS	kPa	psi	kPa	psi	kPa	psi	
F10b	600/50-22.5/20	Front, Rear	Front, Rear					Front, Rear	350	51	500	73	550	80
8 wheels	710/40-22.5/16				Front, Rear				350	51	400	58	550	80

Machine	Tire size / PR	Tread pattern						Inflation pressure					
								Front		Rear		Max inflation and track pressure	
		F2	TRS 2	TRS 2+	F *Nordman F	Rider	TRS *Nordman TRS	kPa	psi	kPa	psi	kPa	psi
	710/40-22.5/20	Front, Rear	Front, Rear					350	51	500	73	550	80
F10d	600/50-22.5/20	Front, Rear	Front, Rear				Front, Rear	350	51	550	80	550	80
8 wheels	710/40-22.5/20	Front, Rear	Front, Rear					350	51	550	80	550	80
F11d	600/50-24.5/20		Front, Rear					350	51	550	80	550	80
8 wheels	710/40-24.5/20	Front, Rear	Front, Rear		Front, Rear *Front, Rear			350	51	550	80	550	80
	800/40-24.5/20	Front, Rear	Front, Rear					350	51	550	80	550	80
F13c	600/55-26.5/20	Front, Rear	Front, Rear		Front, Rear *Front, Rear		*Front, Rear	350	51	550	80	550	80
8 wheels	600/55R26.5					Front, Rear		350	51	550	80	550	80
	710/45-26.5/20	Front, Rear	Front, Rear		Front, Rear *Front, Rear		*Front, Rear	350	51	500	73	550	80
	710/45R26.5					Front, Rear		350	51	500	73	550	80
	800/40-26.5/20	Front, Rear	Front, Rear		Front, Rear			350	51	500	73	550	80
F15c	600/55-26.5/20	Front, Rear	Front, Rear		Front, Rear *Front, Rear		*Front, Rear	450	65	550	80	550	80
8 wheels	600/55R26.5					Front, Rear		450	65	550	80	550	80
	710/45-26.5/20	Front, Rear	Front, Rear		Front, Rear *Front, Rear		*Front, Rear	400	58	550	80	550	80
	710/45R26.5					Front, Rear		400	58	550	80	550	80
	800/40-26.5/20	Front, Rear	Front, Rear		Front, Rear			400	58	550	80	550	80
F18	750/55-26.5/20				Rear, *Rear		Rear, *Rear			550	80	550	80





Machine	Tire size / PR	Tread pattern						Inflation pressure					
								Front		Rear		Max inflation and track pressure	
		F2	TRS 2	TRS 2+	F *Nordman F	Rider	TRS *Nordman TRS	kPa	psi	kPa	psi	kPa	psi
6 wheels	750/55-26.5/24	Rear	Rear							600	87	600	87
	780/55-26.5/20				Rear					550	80	550	80
	700/70-34/16						Front	260	38			260	38
	700/70-34/20						*Front	320	46			360	52
	710/70-34/24			Front				320	46			400	58
	710/70R34					Front		320	46			400	58
F18	750/55-26.5/20				Front, Rear *Front, Rear		Front, Rear *Front, Rear	450	65	550	80	550	80
8 wheels	750/55-26.5/24	Front, Rear	Front, Rear					450	65	600	87	600	87
	780/55-26.5/20				Front, Rear			450	65	550	80	550	80
F20	750/55-26.5/24	Front, Rear	Front, Rear					450	65	600	87	600	87
8 wheels	780/50-28.5/24	Front, Rear	Front, Rear					450	65	600	87	600	87





TIGERCAT HARVESTERS

Machine	Tire size / PR	Tread pattern					Inflation pressure					
							Front		Rear		Max inflation and track pressure	
		F2	TRS 2	TRS 2+	F *Nordman F	TRS *Nordman TRS	kPa	psi	kPa	psi	kPa	psi
1165	600/55-26.5/20	Front	Front		Front	Front	550	80	400	58	550	80
6 wheels	710/45-26.5/20	Front	Front		Front	Front	550	80	400	58	550	80



Machine	Tire size / PR	Tread pattern					Inflation pressure					
							Front		Rear		Max inflation and track pressure	
		F2	TRS 2	TRS 2+	F *Nordman F	TRS *Nordman TRS	kPa	psi	kPa	psi	kPa	psi
	710/45-26.5/24	Front	Front				600	87	400	58	600	87
	600/65-34/24			Rear					400	58	400	58
	710/55-34/24			Rear					400	58	400	58
1165	710/45-26.5/20	Front, Rear	Front, Rear		Front, Rear	Front, Rear	550	80	400	58	550	80
8 wheels	710/45-26.5/24	Front, Rear	Front, Rear		Front, Rear	Front, Rear	600	87	400	58	600	87
1185	750/55-26.5/20				Front, Rear	Front, Rear	550	80	450	65	550	80
8 wheels	750/55-26.5/24	Front, Rear	Front, Rear				600	87	450	65	600	87
	710/55-28.5/24	Front, Rear	Front, Rear				600	87	450	65	600	87
	780/50-28.5/24	Front, Rear	Front, Rear				600	87	450	65	600	87



TIGERCAT FORWARDERS

Machine	Tire size / PR	Tread pattern				Inflation pressure					
						Front		Rear		Max inflation and track pressure	
		F2	TRS 2	F *Nordman F	TRS *Nordman TRS	kPa	psi	kPa	psi	kPa	psi
1055C	600/50-26.5/20	Front, Rear	Front, Rear	Front, Rear	Front, Rear	550	80	550	80	550	80
8 wheels	710/45-26.5/20	Front, Rear	Front, Rear	Front, Rear	Front, Rear	550	80	550	80	550	80
	710/45-26.5/24	Front, Rear				600	87	600	87	600	87
	800/40-26.5/20	Front, Rear	Front, Rear	Front, Rear		550	80	550	80	550	80



Machine	Tire size / PR	Tread pattern				Inflation pressure					
						Front		Rear		Max inflation and track pressure	
		F2	TRS 2	F *Nordman F	TRS *Nordman TRS	kPa	psi	kPa	psi	kPa	psi
1075C	750/55-26.5/20			Front, Rear	Front, Rear	600	87	600	87	600	87
8 wheels	750/55-26.5/24	Front, Rear	Front, Rear			600	87	600	87	600	87
	780/50-28.5/24	Front, Rear	Front, Rear			600	87	600	87	600	87
1085C	750/55-26.5/24	Front, Rear	Front, Rear			600	87	600	87	600	87
8 wheels	780/50-28.5/24	Front, Rear	Front, Rear			600	87	600	87	600	87



ECOLOG HARVESTERS

Machine	Tire size / PR	Tread pattern			Inflation pressure					
		 F2	 TRS 2	 TRS 2+	Front		Rear		Max inflation and track pressure	
					kPa	psi	kPa	psi	kPa	psi
1058H5	600/55-22.5/20	Front, Rear	Front, Rear		400	58	350	51	550	80
8 wheels	710/45-22.5/20	Front, Rear	Front, Rear		400	58	350	51	550	80
550F	600/65-34/24			Front, Rear	300	44	300	44	400	58
4 wheels	710/55-34/24			Front, Rear	300	44	300	44	400	58
550 T-PRO	600/55-26.5/20	Front	Front		400	58			550	80
6 wheels	710/45-26.5/20	Front	Front		400	58			550	80
	600/65-34/20			Rear			350	51	400	58
	710/55-34/20			Rear			350	51	400	58
560F	600/55-26.5/20	Front	Front		450	65			550	80
6 wheels	710/45-26.5/20	Front	Front		450	65			550	80
	600/65-34/20			Rear			350	51	400	58
	710/55-34/20			Rear			350	51	400	58
580F	600/55-26.5/20	Front	Front		500	73			550	80
6 wheels	710/45-26.5/20	Front	Front		500	73			550	80
	600/65-34/24			Rear			350		400	58
	710/55-34/24			Rear			350		400	58
590F	710/55-26.5/24	Front	Front						600	87
6 wheels	710/55-28.5/24	Front	Front						600	87
	710/55-34/24			Rear					400	58

Machine	Tire size / PR	Tread pattern			Inflation pressure					
					Front		Rear		Max inflation and track pressure	
		F2	TRS 2	TRS 2+	kPa	psi	kPa	psi	kPa	psi
	710/70-34/24			Rear					400	58
688F	600/55-26.5/20	Front, Rear	Front, Rear						550	80
8 wheels	710/45-26.5/20	Front, Rear	Front, Rear						550	80
	800/40-26.5/20	Front, Rear	Front, Rear						550	80

ECOLOG FORWARDERS

Machine	Tire size / PR	Tread pattern		Inflation pressure					
				Front		Rear		Max inflation and track pressure	
		F2	TRS 2	kPa	psi	kPa	psi	kPa	psi
750F	600/55-22.5/20	Front, Rear	Front, Rear	350	51	500	73	550	80
8 wheels	710/45-22.5/20	Front, Rear	Front, Rear	350	51	500	73	550	80
1050F	600/55-22.5/20	Front, Rear	Front, Rear	350	51	500	73	550	80
8 wheels	710/45-22.5/20	Front, Rear	Front, Rear	350	51	500	73	550	80
1250F	600/55-26.5/20	Front, Rear	Front, Rear	400	58	550	80	550	80
8 wheels	710/45-26.5/20	Front, Rear	Front, Rear	400	58	500	73	550	80
	710/45-26.5/24	Front, Rear	Front, Rear	400	58	500	73	600	87
	800/40-26.5/20	Front, Rear	Front, Rear	400	58	500	73	550	80
574F	600/55-26.5/20	Front, Rear	Front, Rear	400	58	550	80	550	80
8 wheels	710/45-26.5/20	Front, Rear	Front, Rear	400	58	550	80	550	80

Machine	Tire size / PR	Tread pattern		Inflation pressure					
		 F2	 TRS 2	Front		Rear		Max inflation and track pressure	
				kPa	psi	kPa	psi	kPa	psi
	710/45-26.5/24	Front, Rear	Front, Rear	400	58	550	80	600	87
	800/40-26.5/20	Front, Rear	Front, Rear	400	58	550	80	550	80
584F	710/45-26.5/20	Front, Rear	Front, Rear	400	58	550	80	550	80
8 wheels	710/45-26.5/24	Front, Rear	Front, Rear	400	58	600	87	600	87
	800/40-26.5/20	Front, Rear	Front, Rear	400	58	550	80	550	80
594F	750/55-26.5/24	Front, Rear	Front, Rear	450	65	600	87	600	87
8 wheels	710/55-28.5/24	Front, Rear	Front, Rear	450	65	600	87	600	87
	780/55-28.5/24	Front, Rear	Front, Rear	450	65	600	87	600	87

GROUND CONTACT PRESSURE COMPARISON

GROUND PRESSURE COMPARISON BETWEEN DIFFERENT TIRE SIZES

Both the tire diameter and width have an important role in determining the size of tire contact area. In practice the tire diameter increase has greater effect on machine mobility than the width increase. Due to the variation in operating ground the absolute ground pressure values can be difficult to assess. However the information in this table is useful when comparing the relative performance of different tires.

CONTACT AREA AND GROUND PRESSURE AT DIFFERENT TYRE LOADS. SOFT SOIL.

Size	600/50-22.5		710/40-22.5		710/40-24.5		500/60-26.5		600/55-26.5		650/60-26.5		650/65-26.5		710/45-26.5		
	mm	in	mm	in	mm	in	mm	in	mm	in	mm	in	mm	in	mm	in	
Diameter	1171	46,1	1171	46,1	1230	48,4	1273	50,1	1340	52,8	1485	58,5	1485	58,5	1340	52,8	
Width	601	23,7	710	28,0	710	28,0	503	19,8	601	23,7	650	25,6	650	25,6	710	28,0	
	cm ²	in ²	cm ²	in ²	cm ²	in ²	cm ²	in ²	cm ²	in ²	cm ²	in ²	cm ²	in ²	cm ²	in ²	
Contact area *)	3520	545,56	4160	644,76	4370	677,31	3200	495,97	4030	624,61	4830	748,6	4830	748,6	4760	737,75	
Load	Ground pressure		Ground pressure		Ground pressure		Ground pressure		Ground pressure		Ground pressure		Ground pressure		Ground pressure		
kg	lb	kg/cm²	lb/in²	kg/cm²	lb/in²	kg/cm²	lb/in²	kg/cm²	lb/in²	kg/cm²	lb/in²	kg/cm²	lb/in²	kg/cm²	lb/in²	kg/cm²	lb/in²
500	1100	0,14	2,02	0,12	1,71	0,11	1,62	0,16	2,22	0,12	1,76	0,10	1,47	0,10	1,47	0,11	1,49
1000	2205	0,28	4,04	0,24	3,42	0,23	3,26	0,31	4,45	0,25	3,53	0,21	2,95	0,21	2,95	0,21	2,99
1500	3305	0,43	6,06	0,36	5,13	0,34	4,88	0,47	6,66	0,37	5,29	0,31	4,41	0,31	4,41	0,32	4,48

2000	4410	0,57	8,08	0,48	6,84	0,46	6,51	0,63	8,89	0,50	7,06	0,41	5,89	0,41	5,89	0,42	5,98
2500	5510	0,71	10,10	0,60	8,55	0,57	8,14	0,78	11,11	0,62	8,82	0,52	7,36	0,52	7,36	0,53	7,47
3000	6615	0,85	12,13	0,72	10,26	0,69	9,77	0,94	13,34	0,74	10,59	0,62	8,84	0,62	8,84	0,63	8,97
3500	7715	0,99	14,14	0,84	11,97	0,80	11,39	1,09	15,56	0,87	12,35	0,72	10,31	0,72	10,31	0,74	10,46
4000	8820	1,14	16,17	0,96	13,68	0,92	13,02	1,25	17,78	0,99	14,12	0,83	11,78	0,83	11,78	0,84	11,96
4500	9920	1,28	18,18	1,08	15,39	1,03	14,65			1,12	15,88	0,93	13,25	0,93	13,25	0,95	13,45
5000	11025	1,42	20,21			1,14	16,28			1,24	17,65	1,04	14,73	1,04	14,73	1,05	14,94
5500	12125	1,56	22,22			1,26	17,90			1,36	19,41	1,14	16,20	1,14	16,20	1,16	16,44
6000	13230					1,37	19,53			1,49	21,18	1,24	17,67	1,24	17,67	1,26	17,93
6500	14330									1,61	22,94	1,35	19,14	1,35	19,14	1,37	19,42
7000	15430											1,45	20,61	1,45	20,61	1,47	20,91
7500	16535											1,55	22,09	1,55	22,09	1,58	22,41
8000	17635											1,66	23,56	1,66	23,56		
8500	18740													1,76	25,03		
9000	19840																
9500	20945																
10000	22045																

*) CONTACT AREA CALCULATED BY USING A FORMULA BY THE SWEDISH FORESTRY RESEARCH INSTITUTE (SKOGSARBETEN).

CONTACT AREA AND GROUND PRESSURE AT DIFFERENT TYRE LOADS. SOFT SOIL.

	750/55-26.5		780/55-26.5		800/50R26.5		710/55-28.5		780/50-28.5		800/40-26.5		600/65-34		700/55-34		700/70-34	
	mm	in	mm	in	mm	in	mm	in	mm	in	mm	in	mm	in	mm	in	mm	in
Diameter	1485	58,5	1485	58,5	1485	58,5	1525	60,0	1525	60,0	1340	52,8	1644	64,7	1485	58,5	1844	72,6

Width		750	29,5	780	30,7	800	31,5	710	28,0	780	30,7	800	31,5	600	23,6	700	27,6	700	27,6
		cm ²	in ²	cm ²	in ²	cm ²	in ²	cm ²	in ²	cm ²	in ²	cm ²	in ²	cm ²	in ²	cm ²	in ²	cm ²	in ²
Contact area ¹⁾		5570	863,29	5790	897,39	5940	920,64	5410	838,5	5950	922,191	5360	830,75	4930	764,101	5200	805,948	6450	999,686
Load		Ground pressure		Ground pressure		Ground pressure		Ground pressure		Ground pressure		Ground pressure		Ground pressure		Ground pressure		Ground pressure	
kg	lb	kg/cm ²	lb/in ²	kg/cm ²	lb/in ²	kg/cm ²	lb/in ²	kg/cm ²	lb/in ²	kg/cm ²	lb/in ²	kg/cm ²	lb/in ²	kg/cm ²	lb/in ²	kg/cm ²	lb/in ²	kg/cm ²	lb/in ²
500	1100	0,09	1,27	0,09	1,23	0,08	1,19	0,09	1,31	0,08	1,19	0,09	1,32	0,10	1,44	0,10	1,36	0,08	1,10
1000	2205	0,18	2,55	0,17	2,46	0,17	2,40	0,18	2,63	0,17	2,39	0,19	2,65	0,20	2,89	0,19	2,74	0,16	2,21
1500	3305	0,27	3,83	0,26	3,68	0,25	3,59	0,28	3,94	0,25	3,58	0,28	3,98	0,30	4,33	0,29	4,10	0,23	3,31
2000	4410	0,36	5,11	0,35	4,91	0,34	4,79	0,37	5,26	0,34	4,78	0,37	5,31	0,41	5,77	0,38	5,47	0,31	4,41
2500	5510	0,45	6,38	0,43	6,14	0,42	5,98	0,46	6,57	0,42	5,97	0,47	6,63	0,51	7,21	0,48	6,84	0,39	5,51
3000	6615	0,54	7,66	0,52	7,37	0,51	7,19	0,55	7,89	0,50	7,17	0,56	7,96	0,61	8,66	0,58	8,21	0,47	6,62
3500	7715	0,63	8,94	0,60	8,60	0,59	8,38	0,65	9,20	0,59	8,37	0,65	9,29	0,71	10,10	0,67	9,57	0,54	7,72
4000	8820	0,72	10,22	0,69	9,83	0,67	9,58	0,74	10,52	0,67	9,56	0,75	10,62	0,81	11,54	0,77	10,94	0,62	8,82
4500	9920	0,81	11,49	0,78	11,05	0,76	10,78	0,83	11,83	0,76	10,76	0,84	11,94	0,91	12,98	0,87	12,31	0,70	9,92
5000	11025	0,90	12,77	0,86	12,29	0,84	11,98	0,92	13,15	0,84	11,96	0,93	13,27	1,01	14,43	0,96	13,68	0,78	11,03
5500	12125	0,99	14,05	0,95	13,51	0,93	13,17	1,02	14,46	0,92	13,15	1,03	14,60			1,06	15,04	0,85	12,13
6000	13230	1,08	15,33	1,04	14,74	1,01	14,37	1,11	15,78	1,01	14,35	1,12	15,93			1,15	16,42	0,93	13,23
6500	14330	1,17	16,60	1,12	15,97	1,09	15,57	1,20	17,09	1,09	15,54	1,21	17,25					1,01	14,33
7000	15430	1,26	17,87	1,21	17,19	1,18	16,76	1,29	18,40	1,18	16,73							1,09	15,43
7500	16535	1,35	19,15	1,30	18,43	1,26	17,96	1,39	19,72	1,26	17,93								
8000	17635	1,44	20,43	1,38	19,65	1,35	19,16	1,48	21,03	1,34	19,12								
8500	18740	1,53	21,71	1,47	20,88	1,43	20,36	1,57	22,35	1,43	20,32								
9000	19840	1,62	22,98	1,55	22,11	1,52	21,55	1,66	23,66	1,51	21,51								

9500	20945	1,71	24,26	1,64	23,34	1,60	22,75	1,76	24,98	1,60	22,71							
10000	22045	1,80	25,54	1,73	24,57	1,68	23,95	1,85	26,29	1,68	23,91							

*) CONTACT AREA CALCULATED BY USING A FORMULA BY THE SWEDISH FORESTRY RESEARCH INSTITUTE (SKOGSARBETEN).

CONTACT AREA AND GROUND PRESSURE AT DIFFERENT TYRE LOADS. SOFT SOIL.

		23.1-26		28L-26		30.5L-32		620/75-26		500/70-28		540/70-30		600/70-38		650/75-38	
		mm	in	mm	in	mm	in	mm	in	mm	in	mm	in	mm	in	mm	in
Diameter		1632	64,3	1644	64,7	1857	73,1	1590	62,6	1405	55,3	1515	59,6	1820	71,7	1965	77,4
Width		587	23,1	714	28,1	775	30,5	625	24,6	503	19,8	540	21,3	611	24,1	650	25,6
		cm ²	in ²	cm ²	in ²	cm ²	in ²	cm ²	in ²	cm ²	in ²	cm ²	in ²	cm ²	in ²	cm ²	in ²
Contact area *)		4790	742,4	5870	909,79	7200	1115,9	4970	770,3	3530	547,11	4090	633,91	5560	861,74	6390	990,39
Load		Ground pressure		Ground pressure		Ground pressure		Ground pressure		Ground pressure		Ground pressure		Ground pressure		Ground pressure	
kg	lb	kg/cm ²	lb/in ²	kg/cm ²	lb/in ²	kg/cm ²	lb/in ²	kg/cm ²	lb/in ²	kg/cm ²	lb/in ²	kg/cm ²	lb/in ²	kg/cm ²	lb/in ²	kg/cm ²	lb/in ²
500	1100	0,10	1,48	0,09	1,21	0,07	0,99	0,10	1,43	0,14	2,01	0,12	1,74	0,09	1,28	0,08	1,11
1000	2205	0,21	2,97	0,17	2,42	0,14	1,98	0,20	2,86	0,28	4,03	0,24	3,48	0,18	2,56	0,16	2,23
1500	3305	0,31	4,45	0,26	3,63	0,21	2,96	0,30	4,29	0,42	6,04	0,37	5,21	0,27	3,84	0,23	3,34
2000	4410	0,42	5,94	0,34	4,85	0,28	3,95	0,40	5,73	0,57	8,06	0,49	6,96	0,36	5,12	0,31	4,45
2500	5510	0,52	7,42	0,43	6,06	0,35	4,94	0,50	7,15	0,71	10,07	0,61	8,69	0,45	6,39	0,39	5,56
3000	6615	0,63	8,91	0,51	7,27	0,42	5,93	0,60	8,59	0,85	12,09	0,73	10,44	0,54	7,68	0,47	6,68
3500	7715	0,73	10,39	0,60	8,48	0,49	6,91	0,70	10,02	0,99	14,10	0,86	12,17	0,63	8,95	0,55	7,79
4000	8820	0,84	11,88	0,68	9,69	0,56	7,90	0,80	11,45	1,13	16,12	0,98	13,91	0,72	10,24	0,63	8,91
4500	9920	0,94	13,36	0,77	10,90	0,63	8,89	0,91	12,88			1,10	15,65	0,81	11,51	0,70	10,02

5000	11025	1,04	14,85	0,85	12,12	0,69	9,88	1,01	14,31					0,90	12,79	0,78	11,13
5500	12125	1,15	16,33	0,94	13,33	0,76	10,87	1,11	15,74					0,99	14,07	0,86	12,24
6000	13230	1,25	17,82	1,02	14,54	0,83	11,86							1,08	15,35	0,94	13,36
6500	14330					0,90	12,84							1,17	16,63	1,02	14,47
7000	15430					0,97	13,83									1,10	15,58
7500	16535					1,04	14,82										
8000	17635					1,11	15,80										
8500	18740																
9000	19840																
9500	20945																

***) CONTACT AREA CALCULATED BY USING A FORMULA BY THE SWEDISH FORESTRY RESEARCH INSTITUTE (SKOGSARBETEN).**

CONTACT AREA AND GROUND PRESSURE AT DIFFERENT TYRE LOADS. SOFT SOIL.

		16.9-28		16.9-30		16.9-34		18.4-34		18.4-38		20.8-38	
		mm	in	mm	in	mm	in	mm	in	mm	in	mm	in
Diameter		1435	56,5	1485	58,5	1585	62,4	1650	65,0	1750	68,9	1840	72,4
Width		429	16,9	429	16,9	429	16,9	467	18,4	467	18,4	528	20,8
		cm ²	in ²	cm ²	in ²	cm ²	in ²	cm ²	in ²	cm ²	in ²	cm ²	in ²
Contact area *)		3080	477,37	3190	494,42	3400	526,97	3850	596,71	4090	633,909	4860	753,25
Load		Ground pressure		Ground pressure		Ground pressure		Ground pressure		Ground pressure		Ground pressure	
kg	lb	kg/cm²	lb/in²	kg/cm²	lb/in²	kg/cm²	lb/in²	kg/cm²	lb/in²	kg/cm²	lb/in²	kg/cm²	lb/in²
500	1100	0,16	2,30	0,16	2,22	0,15	2,09	0,13	1,84	0,12	1,74	0,10	1,46
1000	2205	0,32	4,62	0,31	4,46	0,29	4,18	0,26	3,70	0,24	3,48	0,21	2,93

1500	3305	0,49	6,92	0,47	6,68	0,44	6,27	0,39	5,54	0,37	5,21	0,31	4,39
2000	4410	0,65	9,24	0,63	8,92	0,59	8,37	0,52	7,39	0,49	6,96	0,41	5,85
2500	5510	0,81	11,54	0,78	11,14	0,74	10,46	0,65	9,23	0,61	8,69	0,51	7,31
3000	6615	0,97	13,86	0,94	13,38	0,88	12,55	0,78	11,09	0,73	10,44	0,62	8,78
3500	7715	1,14	16,16	1,10	15,60	1,03	14,64	0,91	12,93	0,86	12,17	0,72	10,24
4000	8820					1,18	16,74	1,04	14,78	0,98	13,91	0,82	11,71
4500	9920							1,17	16,62	1,10	15,65	0,93	13,17
5000	11025											1,03	14,64
5500	12125											1,13	16,10
6000	13230												
6500	14330												
7000	15430												
7500	16535												
8000	17635												
8500	18740												
9000	19840												
9500	20945												

***) CONTACT AREA CALCULATED BY USING A FORMULA BY THE SWEDISH FORESTRY RESEARCH INSTITUTE (SKOGSARBETEN).**

CONTACT AREAS ON A HARD DRIVING SURFACE

TRI patterns have a significantly larger net contact area compared with traditional tractor drive tires. This results in significant improvement in friction rate, grip, and wear rate.

GROUND CONTACT AREA RATIOS

**NORMAL TRACTOR
DRIVE TIRE**

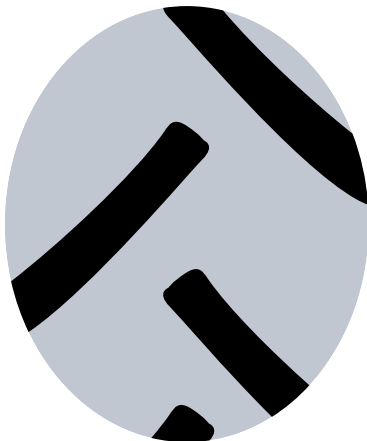

20-25 % net contact area

**NORMAL SECTION
TRI**



42 % net contact area

**80 SERIES
TRI 2**

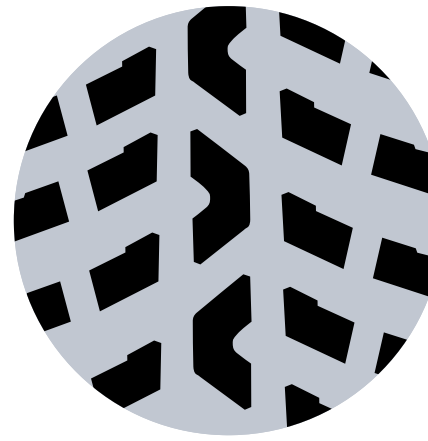

39% net contact area

**80 SERIES
HAKKAPELIITTA TRI**

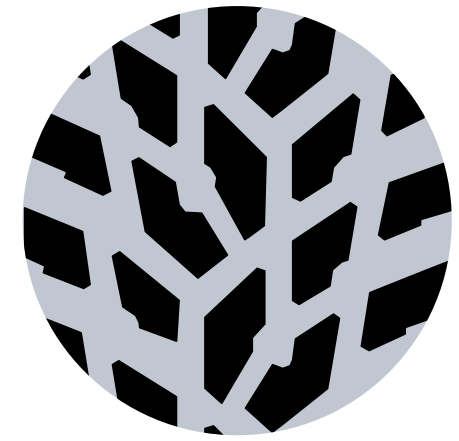

45 % net contact area

CONTACT AREA ON HARD SURFACE

The deflection takes place only on the tire and not at all on the ground. The values in the table are valid at the nominal load and air pressure conditions.

CONTACT AREA ON SOFT SOIL

The deflection takes place mainly on the ground: the tire sinks 15% of its diameter into ground, but the deflection will recover to half of the original value. It is impossible to compare actual measurements in different places, but comparison between different tire sizes is possible with the help of the table below.

Compared to the corresponding standard dimension TRI 2 tire commonly gives an appr. 5–10% larger contact area.

65 series tires will give an approximately 20–30% larger area compared to corresponding sizes with a normal section.

NOKIAN TYRES TRI 2

Size	Contact area			
	Hard surface		Soft surface	
	cm ²	in ²	cm ²	in ²
85-series				
320/85R28	806	125	1 994	309
80-series				
250/80R16	376	58	1 091	169
340/80R18	711	110	1 717	266
360/80R20	810	126	1 950	302
300/80R24	674	104	1 608	249
340/80R24	755	117	1 980	307
360/80R24	458	131	2 115	328
400/80R24	1 035	160	2 525	391
440/80R24	1 200	186	2 895	449
360/80R28	947	147	2 324	360
400/80R28	1 065	165	2 730	423
440/80R28	1 270	197	3 120	484
440/80R30	1 290	200	3 230	501
480/80R30	1 515	235	3 665	568
440/80R34	1 375	213	3 445	535
480/80R34	1 590	246	3 910	606
480/80R38	1 645	255	4 150	643
540/80R38	2 030	315	5 030	780
620/80R42	2 743	425	6 434	997
75-series				
270/75R15	371	58	1 086	168
250/75R16	323	50	1 009	156
70-series				

Size	Contact area			
	Hard surface		Soft surface	
	cm ²	in ²	cm ²	in ²
360/70R20	735	114	1 835	284
500/70R24	1 523	236	3 608	559
65-series				
420/65R24	960	149	2 415	374
460/65R24	1 178	183	2 742	425
540/65R24	1 523	236	3 608	559
480/65R28	1 352	210	3 086	478
540/65R28	1 639	254	3 740	580
540/65R30	1 698	263	3 867	599
600/65R38	2 239	347	4 976	771
650/65R38	2 524	391	5 657	877
650/65R42	2 666	413	5 953	923

NOKIAN TYRES TRI

Size	Contact area			
	Hard surface		Soft surface	
	cm ²	in ²	cm ²	in ²
11.2R24	530	82	1 530	237
16.9R24	1 130	175	2 810	436
16.9R30	1 180	183	3 130	485
18.4R30	1 440	223	3 570	533
65-series				
420/65R24	940	146	2 370	367
460/65R24	1 040	161	2 650	411
480/65R24	1 150	178	2 910	451
520/65R24	1 430	222	3 410	529
480/65R28	1 145	177	3 070	476
600/65R38	2 110	327	5 020	778
Bias Beltet				
18.4B30	1 440	223	3 575	544
580/65B30	1 870	290	4 440	688
580/65B34	1 990	308	4 730	733

STUDS AND CHAINS

STUDS

Nokian Tyres TRI 2, Nokian Tyres TRI, Nokian Tyres Hakkapeliitta Loader and Nokian Tyres Loader Grip patterns offer an excellent winter grip. To gain even more traction and grip in extreme wet icy conditions the tires can be studded. The following schematic pictures show the studding sequence.

STUD RECOMMENDATION

- Recommended types are truck, tractor or construction machine studs
- Maximum stud length is 25 mm / 1 in
- Minimum stud flange is 9 mm / 11/32 in

STUD DIMENSIONING EXAMPLES

Stud marking	Stud length		Flange diameter		Stud hole diameter		Stud protusion	
	mm	in	mm	in	mm	in	mm	in
9 - 15	15	19/32	9	11/32	4	5/32	2	3/32
11 - 15	15	19/32	11	14/32	5	6/32	2	3/32
11 - 17	17	21/32	11	14/32	5	6/32	2.5	3/32
12 - 17	17	21/32	12	15/32	5	6/32	2.5	3/32
12 - 20	20	25/32	12	15/32	5	6/32	3	4/32
12 - 24	24	30/32	12	15/32	6	8/32	3	4/32
16 - 19	19	24/32	16	20/32	7	9/32	2.5	3/32

NOKIAN TYRES HAKKAPELIITTA TRI

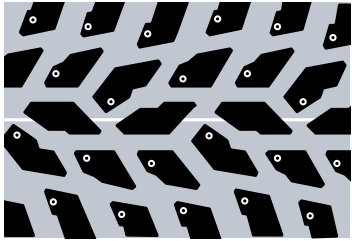

Stud places marked

NOKIAN TYRES TRI 65 SERIES

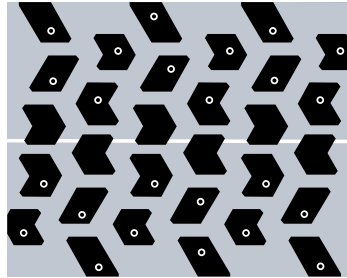

NOKIAN TYRES HAKKAPELIITTA LOADER

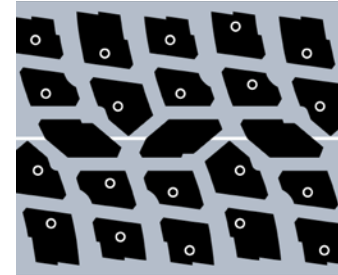

NOKIAN TYRES TRI

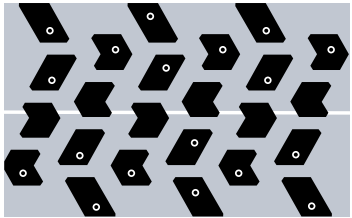

NOKIAN TYRES GROUND KING

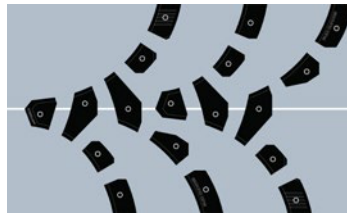

NOKIAN TYRES LOADER GRIP

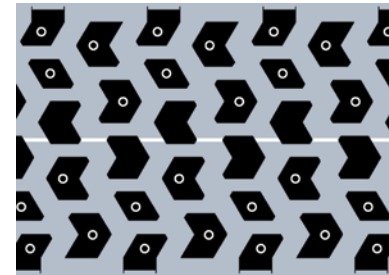

NOKIAN TYRES TRI 2

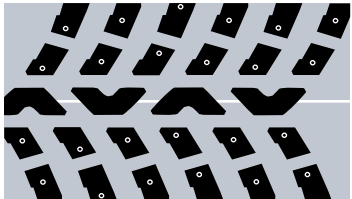

NUMBER OF STUDS - NOKIAN TYRES TRI 2

Size	Pattern	Number of studs
85-series		
320/85R28	TRI 2	168
80-series		
250/80R16	TRI 2	144
340/80R18	TRI 2	144
360/80R20	TRI 2	144
300/80R24	TRI 2	168
340/80R24	TRI 2	168
360/80R24	TRI 2	168
400/80R24	TRI 2	168
440/80R24	TRI 2	168
360/80R28	TRI 2	168
400/80R28	TRI 2	168
440/80R28	TRI 2	168
440/80R30	TRI 2	168
480/80R30	TRI 2	168
440/80R34	TRI 2	192
480/80R34	TRI 2	192
480/80R38	TRI 2	192
540/80R38	TRI 2	192
620/80R42	TRI 2	192

Size	Pattern	Number of studs
75-series		
270/75R15	TRI 2	144
250/75R16	TRI 2	144
70-series		
360/70R20	TRI 2	144
500/70R24	TRI 2	168
600/70R34	TRI 2	192
710/70R42	TRI 2	192
65-series		
420/65R24	TRI 2	168
460/65R24	TRI 2	168
540/65R24	TRI 2	168
480/65R28	TRI 2	168
540/65R28	TRI 2	168
540/65R30	TRI 2	168
600/65R34	TRI 2	192
600/65R38	TRI 2	192
650/65R38	TRI 2	192
650/65R42	TRI 2	192

NUMBER OF STUDS - NOKIAN TYRES TRI

Size	Pattern	Number of studs
65-series		
460/65R24	TRI	176
480/65R24	TRI	184
Bias Beltet		
18.4B34	TRI	144
580/65B30	TRI	184
580/65B34	TRI	192

NUMBER OF STUDS - NOKIAN TYRES HAKKAPELIITTA TRI

Size	Number of studs	Max. stud flange diameter (mm)	Max. stud height (mm)
400/60R18	120	9	20
340/80R18	120	9	20
360/80R20	144	9	20
400/70R20	168	9	24
420/65R24	168	9	24
360/80R24	168	9	24
400/80R24	168	9	24
440/80R24	168	9	24
460/70R24	144	12	25
500/70R24	144	12	25
540/70R24	144	12	25
400/80R28	168	9	24
440/80R28	168	12	25
540/65R28	168	12	25
540/65R30	168	12	25
440/80R34	192	12	25
480/80R34	192	12	25
600/70R32	192	12	25
480/80R38	192	12	25
540/80R38	192	12	25
650/65R38	192	12	25
650/65R42	192	12	25

NUMBER OF STUDS - NOKIAN TYRES LOADER GRIP

Size	Number of studs
17.5R25	180
20.5R25	180
23.5R25	172

NUMBER OF STUDS - NOKIAN TYRES HAKKAPELIITTA LOADER

Size	Number of studs
14.00R24	168
17.5R25	168
20.5R25	168
23.5R25	168

CHAINS

It is recommended to use chains only for short periods at a time. Chains shorten the tire lifetime. Nokian Heavy Tyres limited warranty doesn't cover any damages made by accessories including the use of chains.

The use of chains comes into question when extreme conditions require additional grip. Then it is recommended to use chains only at low speeds and remove them when they are not needed anymore (i.e. road transit).

Before installing chains inspect them for sharp edges or welding burs.

Ensure that the chains are at the right tightness. Chains too loose can slip on the tire and cause excessive wear.

It is important to check that no chain rings are broken or that no individual rings have turned so that calks cut into the tire. Calks can cut into the tire also when chains are severely worn and over stretched.

MPT AGILE STUD RECOMMENDATIONS

1) NOKIAN TYRES MPT AGILE TIRES ARE PART OF THE TRUCK TIRE NORM. THEREFORE:

Recommended stud for truck tires has a length of 15 mm / 19/32 nds of an inch and flange diameter of 11 mm / 14/32 nds of inch.

Stud				Drilled stud hole			
Length		Flange diameter		Diameter		Depth	
mm	32 nds in	mm	32 nds in	mm	32 nds in	mm	32 nds in
15	19	11	14	5	6	13	16

2) STUD AMOUNT IN TIRES (EU / SINCE 1ST JULY 2009):

Maximum of 50 pcs of studs allowed for every 1 m / 39,4 inch of tire circumference.

WITH THE MPT AGILE PATTERN TYPE, THE AMOUNT OF STUDS:

365/80R20 MPT Agile	171 pcs max (evenly distributed 168 pcs)
14.00R20 MPT Agile	198 pcs max (evenly distributed 192 pcs)
14 00R20 MPT Agile 2	198 pcs max (evenly distributed 182 pcs)

TRUCK TIRE STUD (MAX. 5 G / 0.18 OZ)

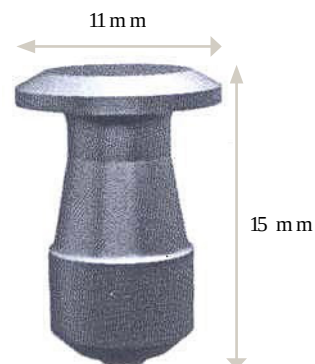

STUD PLACES IN MPT TIRES



O = Normal stud places, 144 in total
X = Additional stud places, 72 pcs

Notice! Please check your local legislation on stud use.

MOUNTING TIRES ON FOUR WHEEL DRIVE TRACTORS

The mounting of tires on a four wheel drive tractor must be done with great care in order to produce the best driving results and maintain the tires' service life. Generally, the actual rolling circumference of a front tire should be 1–4 % higher than the rolling circumference calculated using the gear ratio. Excessive traction in the front tires can cause quick wear and reduce mileage, while insufficient traction in the front tires will make the tractor more difficult to steer. Check the manual of the tractor in question for detailed instructions on the calculation of rolling circumferences (gear ratio). When changing the tire size or type, always check the relationship between the rolling circumferences and make sure that the combination is within the limits given by the manufacturer.

EXAMPLES OF THE CALCULATION

The basis for the calculation is the gear ratio between the front and rear axle, with which the rolling circumference of the required front tire can be calculated.

EXAMPLE 1: CALCULATING THE ROLLING CIRCUMFERENCE OF FRONT TIRES

Tire size	Rolling circumference (from tire manufacturer)
16.9R28 TRI	4222 mm
20.8R38 TRI	5448 mm

Tractor gear ratio: 1.329. The target is 1–5% traction (lead) for front tires.

5448 mm (rear tire rolling circumference) / 1.329 (gear ratio) = 4099 mm (no traction)

1% traction:	1.01 x 4099 mm = 4140 mm
5% traction:	1.05 x 4099 mm = 4304 mm

The selected tire 16.9R28 TRI has a rolling circumference (4140 mm < 4222 mm < 4304 mm) which is within the limit given by the manufacturer. The front tire's traction is 4222 / 4099 = 1.030, i.e. 3.0%.

EXAMPLE 2: SWITCHING TO TRI 2 TIRES ON THE ABOVE MENTIONED MACHINE

Gear ratio: 1.329. The target is 1–5% traction for the front tire.

The control calculation must be verified. It must be noted as well that the TRI 2 and TRI tires have a different rolling circumference than a correspondent tire with a lug pattern.

Tire size	Rolling circumference (from tire manufacturer)
440/80R28 TRI 2	4266 mm
540/80R38 TRI 2	5529 mm

Verification:

5529 mm (rear tire rolling circumference) / 1.329 (gear ratio) = 4160 mm (traction 0%)

1% traction:	1.01 x 4160 mm = 4202 mm
5% traction:	1.05 x 4160 mm = 4368 mm

The selected tire 440/80R28 has a rolling circumference (4202 mm < 4266 mm < 4368 mm)

which is within the limit given by the manufacturer.

The front tire's traction is $4266 / 4160 = 1.025$, i.e. 2.5%.

The methods above can be used to check the suitability of new tires when mounting them on a tractor with a known gear ratio. However, if this vital information is not available, you should contact the tractor's manufacturer or importer.

MINE TIRE MAINTENANCE

To utilise the full capacity of a mining tire, it is recommended to check the inflation pressure at least once a week. Keeping the pressure at a sufficient level prevents tire break-up caused by high heat generation. Pressure maintenance reduces cuts and cracks on tire sidewalls by keeping the tire contour in design width.

It is also recommended to keep a tire check diary. This makes it easier to determine the interval and the need for maintenance. A diary helps maintenance when machines are operated in several shifts and by different operators. Regular check-ups help in starting repair procedures early enough to save in tire costs.

When checking the inflation pressure, please observe also the tire temperature. A rise of 10 degrees centigrade / 50 Fahrenheit will increase the inflation pressure approximately 0,35 bar / 5,1 psi at 10 bar pressure level. Use only reliable and calibrated pressure gauges. A regular gauge re-calibration should also be performed.

A cut on a tire sidewall, caused in example by sharp stones, should always be repaired before it proceeds to let moisture reach into the tire reinforcing cords.

Narrow mine tunnels often wear tread more from the outer side of a tire. It is recommended to swap tires from one side to the other to gain more tire hours.

The Nokian Tyres Mine L-5S features a tread wear indicator. Besides this it is also recommended to mark the actual tread wear (mm / in) into the tire check diary.

In handling a TL (tubeless) tire make sure that the rim is not damaged. Even a small abrasion on a tire by a damaged or a faulty rim can lead to excessive air leak. A defective rim is always a serious safety hazard. With a TL tire always use a tubeless rim.

Notice! Regular inflation pressure maintenance ensures long service life.

HAKKAPELIITTA LOADER INFLATION PRESSURE RECOMMENDATIONS FOR DIFFERENT WHEEL LOADERS

SIZE: 17.5R25

Manufacturer	Model	Empty vehicle weight		Tipping load static		Inflation pressure Front axle		Inflation pressure Rear axle	
		kg	lb	kg	lb	kPa	psi	kPa	psi
CAT	IT14G*	8 450	18 629	4 500	9 921	375	54	225	33
CAT	914K*	8 181	18 036	5 578	12 297	375	54	225	33
CAT	924H	11 730	25 860	8 740	19 268	450	65	300	44
JCB	411 & 413S	8 830	19 467	6 610	14 573	375	54	225	33
JCB	417S ZX	9 510	20 966	7 250	15 984	400	58	225	33
JCB	418S ZX	9 600	21 164	7 240	15 962	400	58	250	36
Liebherr	L524	11 100	24 471	8 500	18 739	475	69	300	44
Liebherr	L528	11 500	25 353	9 560	21 076	500	73	325	47
Ljungby	L9	10 500	23 146	6 500	14 330	450	65	300	44
Volvo	L60H	12 400	27 337	6 570	14 484	500	73	300	44

ASSUMPTIONS: Normal bucket. Max speed with full bucket 12.5 mph / *20 mph. Max speed with empty vehicle 25 mph.

ASSUMPTIONS: Normal bucket. Max speed with full bucket 20 km/h / *30 km/h. Max speed with empty vehicle 40 km/h

SIZE: 20.5R25

Manufacturer	Model	Empty vehicle weight		Tipping load static		Inflation pressure Front axle		Inflation pressure Rear axle	
		kg	lb	kg	lb	kPa	psi	kPa	psi
CAT	930K	14 400	31 747	10 100	22 267	400	58	275	40
CAT	938K	16 350	36 046	12 200	26 896	475	69	300	44
Komatsu	270-7	13 100	28 881	10 100	22 267	350	51	225	33
Komatsu	320-7	16 000	35 274	11 560	25 485	450	65	300	44
Liebherr	L538	13 400	29 542	10 700	23 590	375	54	250	36
Liebherr	L542	14 000	30 865	11 600	25 574	400	58	275	40
Volvo	L70H	14 480	31 923	9 860	21 738	400	58	275	40
Volvo	L90H	15 990	35 252	11 470	25 287	450	65	300	44

ASSUMPTIONS: Normal bucket. Max speed with full bucket 12.5 mph. Max speed with empty vehicle 25 mph.

ASSUMPTIONS: Normal bucket. Max speed with full bucket 20 km/h. Max speed with empty vehicle 40 km/h

SIZE: 23.5R25

Manufacturer	Model	Empty vehicle weight		Tipping load static		Inflation pressure Front axle		Inflation pressure Rear axle	
		kg	lb	kg	lb	kPa	psi	kPa	psi
CAT	950K	20 131	44 381	13 719	30 245	450	65	300	44
CAT	962M	20 226	44 591	13 358	29 449	450	65	300	44
Komatsu	WA380-6	17 583	38 764	14 563	32 106	375	54	200	29
Komatsu	WA430-6	18 533	40 858	14 963	32 998	400	58	225	33
Liebherr	L550	16 590	36 575	13 204	29 110	350	51	225	33
Ljungby	L18, Tier IIIB engine	19 000	41 888	13 900	30 644	425	62	275	40
Volvo	L110G	18 405	40 576	14 401	31 749	375	54	225	33
Volvo	L120F	20 010	44 116	14 540	32 055	450	65	300	44

ASSUMPTIONS: Normal bucket. Max speed with full bucket 12.5 mph / *20 mph. Max speed with empty vehicle 25 mph.

ASSUMPTIONS: Normal bucket. Max speed with full bucket 20 km/h / *30 km/h. Max speed with empty vehicle 40 km/h

STUDS

Nokian Tyres Hakkapeliitta Loader pattern offers an excellent winter grip. To gain even more traction and grip in extreme wet icy conditions the tires can be studded. The following schematic picture shows the studding sequence

STUD RECOMMENDATION

- Recommended types are truck, tractor or construction machine studs
- Maximum stud length is 25 mm / 1 in
- Minimum stud flange is 9 mm / 11/32 in

NUMBER OF STUDS

Size	Number of studs
14.00R24	168
17.5R25	168
20.5R25	168
23.5R25	168

NOKIAN TYRES HAKKAPELIITTA LOADER

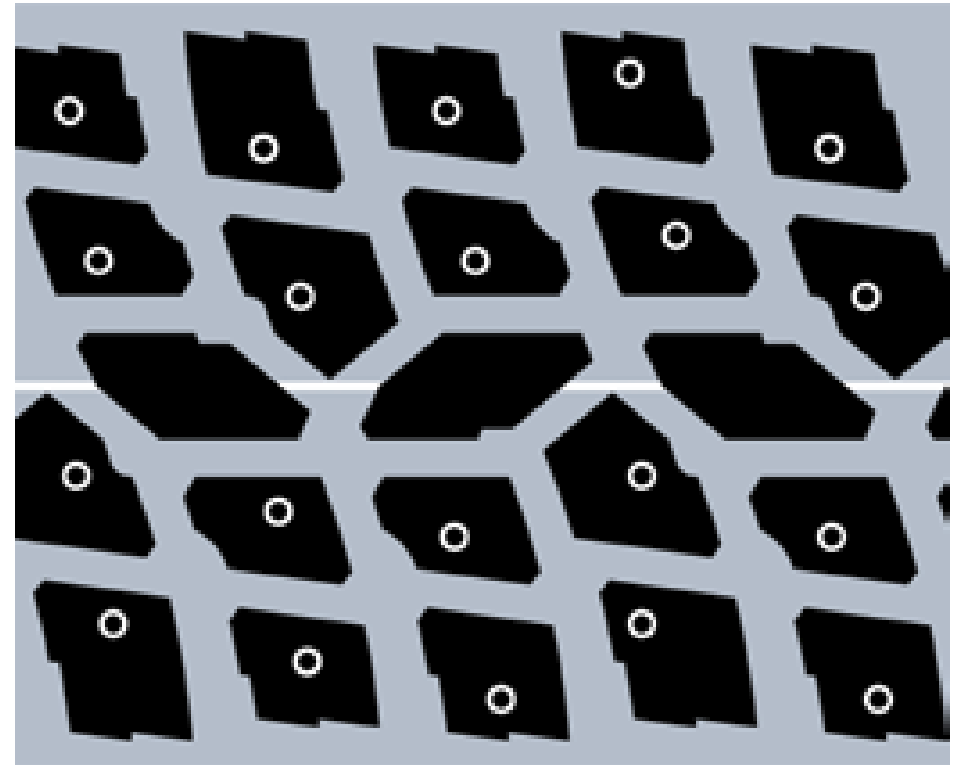

Stud places marked.

GROUND KARE AND EXCAVATOR MOUNTING RECOMMENDATIONS

Nokian Tyres 24PR Excavator and Nokian Tyres Ground Kare tires are developed for high load capacities with a maximum inflation pressure of 600 kPa. Nokian Tyres 20PR Excavator tires are developed for high load capacities with a maximum inflation pressure of 450 kPa.

Please note that the wheel's load capacity must meet the machine requirements. The tire mounted on the wheel must have a high enough load capacity as well. Also make sure that the wheel's maximum inflation pressure capability meets the allowed maximum pressure of the tire.

As stated by the ETRTO, consult the rim and wheel manufacturers for load capacity compatibility ("Standards Manual 2019", p. R.4 "General Notes. Strength.")

The rim's horn (or flange) shall have a shape that does not damage a tire during mounting. Such rims have: a round/tube shape horn or a well bent down/long horn. For the rim's horn suitability, please consult the tire manufacturer.

The rim's contour has to meet ETRTO requirements ("15° Drop-Centre Rims Width Codes AG Contour. Basic Contour" p. R.36, ETRTO 2019). Additionally the diagonal mounting distance has to meet the requirements set by the ETRTO (Engineering Design Information 2019 p. RM.2 "Contour changes of drop-center rims"). For the rim's contour suitability, please contact the tire manufacturer.

Mounting Nokian Tyres Excavator and Nokian Tyres Ground Kare tires always requires a two clamp mounting method by Nokian Tyres. For the bigger clamp, please always use HTTMC00001 clamp developed by Nokian Tyres.

RECOMMENDED SHAPE:

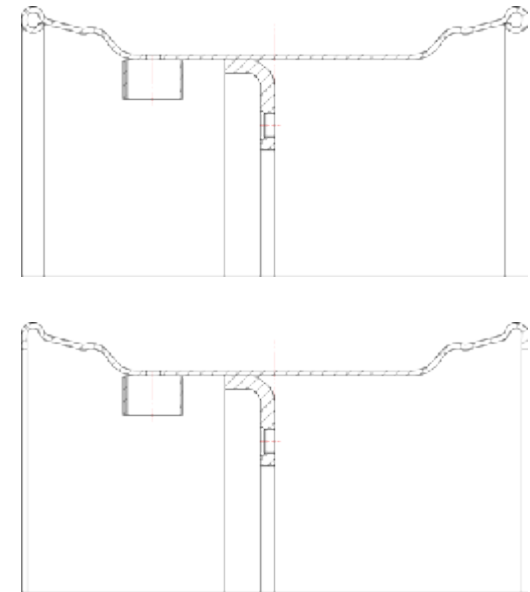

NON-RECOMMENDED SHAPE:

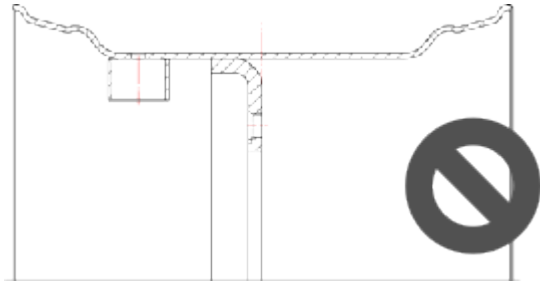



NOKIAN TYRES INTUITU™ SMART TIRES

Digital tires are the key to more efficient, safer and more sustainable working. With Nokian Tyres Intuitu™ smart tires and mobile app, you always know how your tires are doing – from one tire to the entire fleet.

nokian
TYRES

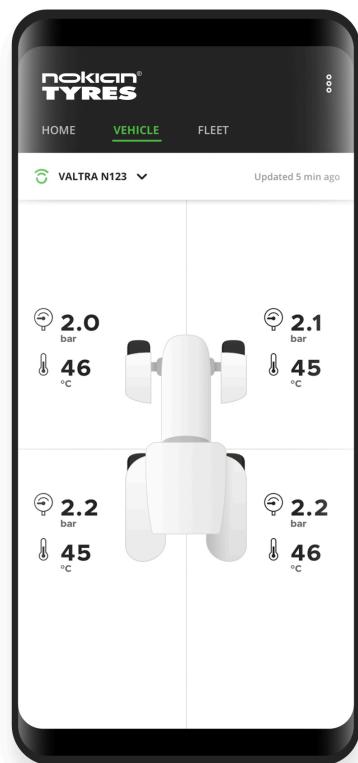

Designed and developed by Nokian Tyres, the Nokian Tyres Intuitu sensor measures tire pressure and temperature directly from the inside surface of the tire. It sends measurements every minute via Bluetooth to the Nokian Tyres Intuitu mobile app.

When the app detects abnormal tire conditions, it alerts the user. With the power of the Intuitu cloud, all drivers and fleet managers can see the condition of all fleet tires remotely (internet connection required).

MORE SAVINGS

Smart tire pressure monitoring is important for grip and stability as well as fuel consumption and tire service life. With Nokian Tyres Intuitu, you can be sure you'll get the most out of your tire investment.

MORE SAFETY

High tire temperatures are linked to tire damage and are a safety risk. Nokian Tyres Intuitu tire monitoring system alerts you on time, making your entire operation more informed, safer and sustainable.

MORE WARRANTY

By registering your tires on Nokian Tyres Intuitu, you will get a one-year extension to normal tire

warranty and a direct communication channel with Nokian Tyres.

TECHNICAL SPECIFICATION

Operating temperature range	-40 to 80°C (+/- 2 °C) (-40 °C to -20 °C with limited functionality and performance)
Pressure measurement range	0-9 bar (+/- 0.04 bar)
Connection to mobile phone	Bluetooth low energy
Sensor battery life	10 000 active hours typical usage. Non-replaceable battery
Phone operating systems	Android 8 onwards iOS 11 onwards
Alarms	Low pressure, high temperature

Notice! Do not use with liquids or innertubes in the tire. For more detailed information and FAQs, please go to www.nokiantyres.com/intuitu

INTUITU SMART TIRES AVAILABLE

- Nokian Tyres TRI 2, all sizes
- Nokian Tyres Hakkapeliitta TRI, all sizes
- Nokian Tyres Ground King, all sizes
- Nokian Tyres Tractor King, all sizes
- Nokian Tyres CT
- Nokian Tyres Country King
- Nokian Tyres ELS

REGROOVING OF NOKIAN TYRES TRUCK & BUS TIRES

INTRODUCTION

Tire regrooving extends the life cycle of Nokian Tyres steel radial tires for buses and trucks. Tire regrooving can be done on new tires by cutting into the tread as instructed by Nokian Tyres.

To ensure safety and minimize tire damages, the following should be taken into account:

- Only professional operators should perform the regrooving process.
- Only competent tools suitable for the process should be used with electrically heated blades.
- The blades in the cutter heads need to be set to the correct, specified depth.
- The blade setting depth for each individual tire must be determined by referring to the information charts presented in this technical manual in order to prevent the appearance of plies at the bottom of the tread and damage to the tire structure.
- The heating of the blade begins automatically when the blade pierces the rubber.
- The cutter must be held in a way that the underside of the cutting head is flat against the tread surface when regrooving.
- During the regrooving process, a minimum depth of leftover under-tread rubber is required to avoid injuries of the top steel belt, stone-chips as well as groove cracking that can cause rib tears.

GUIDELINES

- 1. Before regrooving, tires must be demounted from the wheel completely**
- 2. Inspections the tires must include following steps:**
 - Before regrooving, possible damages on any part of the tire must be checked carefully.
 - When selecting a tire for regrooving, special attention needs to be paid to the tire condition when the tread area is in any way damaged. This includes for example chipping, tearing and cutting due to abnormal operating conditions.
 - Stones and other foreign objects, such as nails and other sharp objects, that may have embedded into the tire grooves must be removed. If needed, the possible damages from the foreign objects must be repaired before starting the regrooving process.
 - When a tire is abnormally or intensely worn, regrooving the worn parts of the tire may still be possible if an adequate amount of the original groove is visible before regrooving.
- 3. The minimum remaining tread depth of the tire should be between 3–4 mm before regrooving.**
 - To find the minimum remaining depth, the tread depth must be measured carefully at 4 different places around the tire circumference.
 - The cutter blade needs to be set for the recommendations as shown in the information charts of this technical manual.
- 4. The regrooved tire should be free from all defects and injuries.**
 - To ensure complete safety, it is extremely important to confirm that the belts under the regrooved tread are not exposed in any parts.

EXAMPLE:

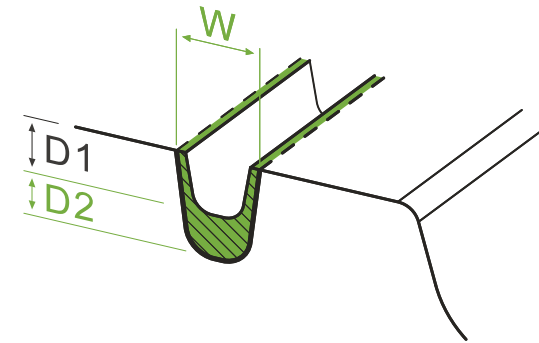

Minimum remaining tread depth = 3 mm (D1)

Recommended regrooving depth = 3 mm (D2)

Depth to which cutter blade is set = 6 mm (D1+D2)

Recommended regrooving width = W

REGROOVING RECOMMENDATIONS

THE MAXIMUM RECOMMENDED DEPTH IS THE INCREASING DEPTH.

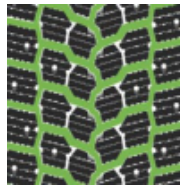

NOKIAN TYRES HAKKAPELIITTA TRUCK E2

Tire size	Regrooving depth	Width of regrooving	Blade
275/70R22.5	2.5 mm	7-8 mm	R3
295/80R22.5	3.0 mm	7-8 mm	R3
315/70R22.5	2.5 mm	7-8 mm	R3
315/80R22.5	3.0 mm	7-8 mm	R3

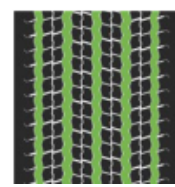

NOKIAN TYRES HAKKAPELIITTA TRUCK F2

Tire size	Regrooving depth	Width of regrooving	Blade
295/80R22.5	3.0 mm	8-9 mm	R3
315/70R22.5	3.0 mm	8-9 mm	R3
315/80R22.5	3.0 mm	8-9 mm	R3
385/55R22.5	3.0 mm	8-9 mm	R3
385/65R22.5	3.0 mm	8-9 mm	R3

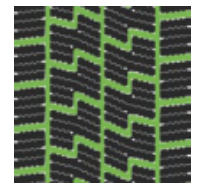

NOKIAN TYRES HAKKAPELIITTA TRUCK D

Tire size	Regrooving depth	Width of regrooving	Blade
275/70R22.5	2.5 mm	7-8 mm	R3
295/80R22.5	3.0 mm	7-8 mm	R3
315/70R22.5	2.5 mm	7-8 mm	R3
315/80R22.5	3.0 mm	7-8 mm	R3

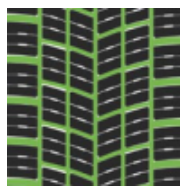

NOKIAN TYRES HAKKA TRUCK DRIVE

Tire size	Regrooving depth	Width of regrooving	Blade
295/60R22.5	2.5 mm	7-8 mm	R3
315/60R22.5	2.5 mm	7-8 mm	R3
295/80R22.5	3.0 mm	7-8 mm	R3
315/70R22.5	3.0 mm	7-8 mm	R3
315/80R22.5	3.0 mm	7-8 mm	R3

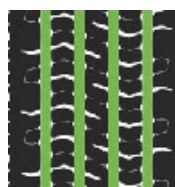

NOKIAN TYRES HAKKA TRUCK COACH

Tire size	Regrooving depth	Width of regrooving	Blade
295/80R22.5	2.5 mm	6-7 mm	R3
315/80R22.5	2.5 mm	6-7 mm	R3

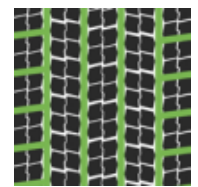

NOKIAN TYRES HAKKAPELIITTA CITY BUS

Tire size	Regrooving depth	Width of regrooving	Blade
275/70R22.5	3.0 mm	6-7 mm	R3
295/80R22.5	2.5 mm	6-7 mm	R3

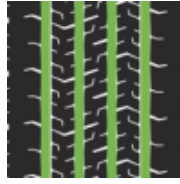

NOKIAN TYRES HAKKA TRUCK STEER

Tire size	Regrooving depth	Width of regrooving	Blade
315/60R22.5	3.0 mm	8-9 mm	R3
295/80R22.5	3.0 mm	8-9 mm	R3
315/70R22.5	3.0 mm	8-9 mm	R3
315/80R22.5	3.0 mm	8-9 mm	R3
385/55R22.5	3.0 mm	8-9 mm	R3
385/65R22.5	3.0 mm	8-9 mm	R3

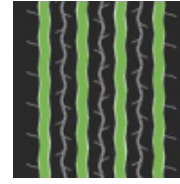

NOKIAN TYRES E-TRUCK TRAILER

Tire size	Regrooving depth	Width of regrooving	Blade
215/75R17.5	2.0 mm	6-7 mm	R3
235/75R17.5	2.0 mm	6-7 mm	R3
245/70R17.5	2.0 mm	6-7 mm	R3
265/70R19.5	2.5 mm	7-9 mm	R3
385/55R22.5	2.5 mm	7-9 mm	R3
385/65R22.5	2.5 mm	7-9 mm	R3

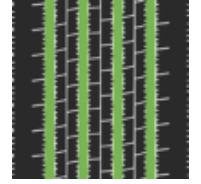

NOKIAN TYRES E-TRUCK STEER

Tire size	Regrooving depth	Width of regrooving	Blade
215/75R17.5	1.5 mm	6-7 mm	R3
235/75R17.5	1.5 mm	6-7 mm	R3
265/70R19.5	1.5 mm	7-8 mm	R3
285/70R19.5	1.5 mm	7-8 mm	R3
295/80R22.5	2.0 mm	8-9 mm	R3
315/70R22.5	2.0 mm	8-9 mm	R3
315/80R22.5	2.5 mm	8-9 mm	R3
385/65R22.5	2.0 mm	8-9 mm	R3
385/55R22.5	2.0 mm	8-9 mm	R3

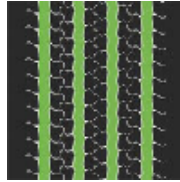

NOKIAN TYRES HAKKA TRUCK TRAILER

Tire size	Regrooving depth	Width of regrooving	Blade
265/70R19.5	2.5 mm	7-8 mm	R3
275/70R22.5	3.0 mm	8-9 mm	R3
385/65R22.5	2.5 mm	8-9 mm	R3
385/55R22.5	2.0 mm	-9mm	R3



NOKIAN TYRES R-TRUCK TRAILER

Tire size	Regrooving depth	Width of regrooving	Blade
265/70R19.5	3.0 mm	7-8 mm	R3
285/70R19.5	3.0 mm	8-10 mm	R4
275/70R22.5	3.0 mm	8-10 mm	R4
385/65R22.5	3.0 mm	8-10 mm	R4



NOKIAN TYRES R-TRUCK STEER

Tire size	Regrooving depth	Width of regrooving	Blade
315/80R22.5	3.0 mm	8-10 mm	R4
385/65R22.5	3.0 mm	8-10 mm	R4

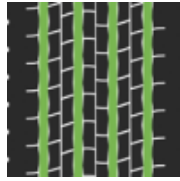

**NOKIAN TYRES HAKKA TRUCK 844/
844PLUS**

Tire size	Regrooving depth	Width of regrooving	Blade
265/70R19.5	2.5 mm	7-8 mm	R3
275/70R22.5	3.0 mm	8-9 mm	R3
385/55R22.5	3.0 mm	8-9 mm	R3



NOKIAN TYRES R-TRUCK DRIVE

Tire size	Regrooving depth	Width of regrooving	Blade
315/80R22.5	3.0 mm	8-10 mm	R4



NOKIAN TYRES E-TRUCK DRIVE

Tire size	Regrooving depth	Width of regrooving	Blade
215/75R17.5	1.5 mm	6-7 mm	R3
235/75R17.5	1.5 mm	6-7 mm	R3
265/70R19.5	1.5 mm	6-7 mm	R3
285/70R19.5	1.5 mm	6-7 mm	R3
295/80R22.5	2.5 mm	7-8 mm	R3
315/70R22.5	2.5 mm	7-8 mm	R3
315/80R22.5	2.5 mm	7-8 mm	R3

STUDDING OF NOKIAN TYRES HAKKAPELIITTA TRUCK BRANDED TIRES

Most of the Nokian Tyres Hakkapeliitta Truck branded tires have pre-marked stud places where the studs can be installed following the below instructions.

- Recommended stud for truck tires has a length of 15 mm and flange diameter of 11 mm. Recommended drilling diameter is 5 mm and drilling depth is 13 mm.
- It should be noted that there are national regulations about the maximum stud weight, which must be followed. For example, in Finland, the maximum stud weight for heavy vehicles (over 3,5 ton) is 5 g.

STUDDING PLAN BY TREAD DESIGN AND TIRE SIZE

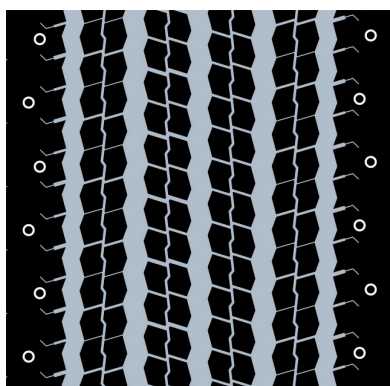

HAKKAPELIITTA TRUCK F2

Tire size	Number of studs
295/80R22.5	158
315/70R22.5	152
315/80R22.5	160
385/55R22.5	136
385/65R22.5	142

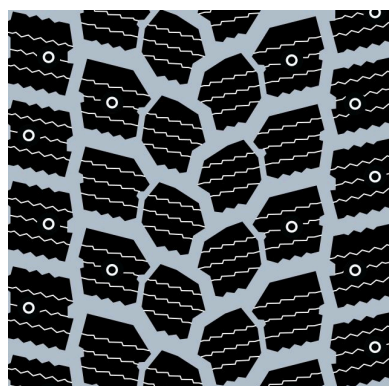

HAKKAPELIITTA TRUCK E2

Tire size	Number of studs
275/70R22.5	150
295/80R22.5	168
315/70R22.5	162
315/80R22.5	174

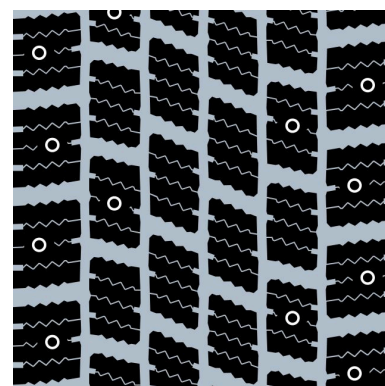

HAKKAPELIITTA TRUCK D

Tire size	Number of studs
275/70R22.5	146



HAKKAPELIITTA TRUCK T



Tire size	Number of studs
265/70R19.5	114

AREAS OF USE AND EU LABEL INFO

EU TIRE LABELS FOR EASY COMPARISON

From May 1st 2021, also truck and bus tires must carry the EU tire label. The labels show important tire properties such as grip, fuel efficiency and noise level at a glance, making it easy to choose a safer, more eco-friendly tire.

You can find the EU label information on each Nokian Tyres product page by clicking on “Show more” under the size information. [NOKIANTYRES.COM/HEAVY/EU-LABELS](https://www.nokiantyres.com/heavy/eu-labels)

	Winter use	Long distance	Regional	Light & medium trucks	Timber transport	On/Off road	Long distance buses	City buses	3PMSF M+S markings
									
Steer									
Hakkapeliitta Truck F2	**	██████████			██████████	██████████	██████████	██████████	3PMSF, M+S
Hakka Truck Coach	**	██████████					██████████		3PMSF, M+S
Hakkapeliitta City Bus	**							██████████	3PMSF, M+S
Hakka Truck Steer	*	██████████					██████████	██████████	3PMSF, M+S
Hakka Truck 844PLUS	*		██████████					██████████	3PMSF, M+S
E-Truck Steer	*	██████████					██████████	██████████	3PMSF, M+S
E-Truck Steer 17.5"	*			██████████				██████████	3PMSF, M+S
E-Truck Steer 19.5"	*		██████████	██████████					3PMSF, M+S
R-Truck Steer	*				██████████	██████████			3PMSF, M+S
Drive									
Hakkapeliitta Truck D	**	██████████	██████████				██████████	██████████	3PMSF, M+S
Hakkapeliitta Truck E/E2	**	██████████	██████████		██████████	██████████	██████████	██████████	3PMSF, M+S
Hakka Truck Coach	**	██████████					██████████		3PMSF, M+S

	Winter use 	Long distance 	Regional 	Light & medium trucks 	Timber transport 	On/Off road 	Long distance buses 	City buses 	3PMSF M+S markings
Hakkapeliitta City Bus	**								3PMSF, M+S
Hakka Truck Drive	**								3PMSF, M+S
Hakkapeliitta Truck T	**								3PMSF, M+S
E-Truck Drive	*								3PMSF, M+S
E-Truck Drive 17.5"	*								3PMSF, M+S
E-Truck Drive 19.5"	*								3PMSF, M+S
R-Truck Drive	*								3PMSF, M+S
Trailer									
Hakkapeliitta Truck F2	**								3PMSF, M+S
Hakkapeliitta Truck T	**								3PMSF, M+S
Hakka Truck Trailer	**								3PMSF, M+S
Hakka Truck 844PLUS	*								3PMSF, M+S
Hakka Truck 844	*								3PMSF, M+S
E-Truck Trailer	*								3PMSF, M+S
R-Truck Trailer	*								3PMSF, M+S

** Excellent grip in severe winter conditions

* Good grip in normal winter road conditions

HOW TO USE LOAD CAPACITY TABLES?

Q: HOW TO FIND THE RIGHT INFLATION PRESSURE?

Tire: 650/65R26.5 174 D ELS
Load per tire: 7 000 kg / 15 432 lb
Max speed of vehicle: 40 km/h / 25 mph

A: Correct inflation pressure is 2.8 bar / 41 psi

SIZE 650/65R26.5 174 D

Constant		0.8 bar	12 psi	1.2 bar	17 psi	1.6 bar	23 psi	2.0 bar	29 psi	2.4 bar	35 psi	2.8 bar	41 psi	3.2 bar	46 psi	3.6 bar	53 psi	4.0 bar	58 psi
km/h	mph	kg	lbs	kg	lbs	kg	lbs	kg	lbs	kg	lbs	kg	lbs	kg	lbs	kg	lbs	kg	lbs
10	5	4 260	9 390	5 400	11 905	6 400	14 110	7 200	15 875	8 350	18 410	9 300	20 505	10 100	22 265	11 100	24 470	12 100	26 675
20	12.5	3 900	8 600	4 960	10 935	5 860	12 920	6 600	14 550	7 650	16 865	8 500	18 740	9 250	20 395	10 150	22 375	11 100	24 470
25	15	3 740	8 245	4 740	10 450	5 620	12 390	6 350	14 000	7 350	16 205	8 150	17 965	8 850	19 510	9 750	21 495	10 600	23 370
30	20	3 580	7 890	4 540	10 010	5 380	11 860	6 050	13 340	7 000	15 430	7 800	17 195	8 500	18 740	9 300	20 505	10 150	22 375
40	25	3 220	7 100	4 080	8 995	4 840	10 670	5 440	11 995	6 300	13 870	7 050	15 540	7 650	16 865	8 400	18 520	9 150	20 170
50	30	2 860	6 305	3 640	8 025	4 300	9 480	4 840	10 670	5 600	12 345	6 250	13 780	6 800	14 990	7 450	16 425	8 150	17 965
65	40	2 360	5 205	3 000	6 615	3 550	7 825	4 000	8 820	4 625	10 195	5 150	11 355	5 600	12 345	6 150	13 560	6 700	14 770

Q: HOW TO FIND A MAXIMUM SPEED FOR THE APPLICATION (HIGHEST SPEED WITH THE CHOSEN TIRE)?

Tire: 650/60R34 175 D
Load per tire: 10 000 kg / 22 046 lb
Inflation pressure: 4.0 bar / 58 psi. Use tire maximum inflation pressure to gain the highest speed value

A: Maximum speed is 30 km/h / 20 mph

SIZE 650/60R34 175 D

Constant		0.8 bar	12 psi	1.2 bar	17 psi	1.6 bar	23 psi	2.0 bar	29 psi	2.4 bar	35 psi	2.8 bar	41 psi	3.2 bar	46 psi	3.6 bar	53 psi	4.0 bar	58 psi
km/h	mph	kg	lbs	kg	lbs	kg	lbs	kg	lbs	kg	lbs	kg	lbs	kg	lbs	kg	lbs	kg	lbs
10	5	4 500	9 920	5 540	12 215	6 750	14 880	7 650	16 865	8 550	18 850	9 850	21 715	10 450	23 040	11 350	25 020	12 450	27 445
20	12.5	4 140	9 125	5 080	11 200	6 200	13 670	7 050	15 540	7 850	17 305	9 000	19 840	9 600	21 165	10 400	22 930	11 400	25 130
25	15	3 960	8 730	4 860	10 715	5 940	13 095	6 750	14 880	7 550	16 645	8 650	19 070	9 200	20 280	10 000	22 045	10 950	24 140
30	20	3 780	8 335	4 660	10 275	5 680	12 520	6 450	14 220	7 200	15 875	8 250	18 190	8 800	19 400	9 550	21 055	10 450	23 040
40	25	3 400	7 495	4 200	9 260	5 100	11 245	5 780	12 745	6 500	14 330	7 450	16 425	7 900	17 415	8 600	18 960	9 400	20 725
50	30	3 040	6 700	3 740	8 245	4 540	10 010	5 160	11 375	5 760	12 700	6 600	14 550	7 050	15 540	7 650	16 865	8 350	18 410
65	40	2 500	5 510	3 075	6 780	3 750	8 265	4 250	9 370	4 750	10 470	5 450	12 015	5 800	12 785	6 300	13 890	6 900	15 210

Notice!

Exceeding maximum speed leads to tire overheating resulting in premature break-up.

Q: FOR THE TIRE, WHAT ARE THE REQUIRED (MINIMUM) INFLATION PRESSURES WHEN:

- 1) Driving on the road?
- 2) Working on the field?

Tire: 710/55R34 177 D

Load per tire: 7 000 kg / 15 432 lb

A:

- 1) Vehicle keeps maximum speed in 50 km/h / 30 mph.

With this load the minimum inflation pressure is 2.8 bar/41 psi.

- 2) Maximum speed in field applications is 10 km/h / 5 mph.

With this load the minimum inflation pressure is 1.6 bar / 23 psi.

SIZE 710/55R34 177 D

	Constant	0.8 bar	12 psi	1.2 bar	17 psi	1.6 bar	23 psi	2.0 bar	29 psi	2.4 bar	35 psi	2.8 bar	41 psi	3.2 bar	46 psi	3.6 bar	53 psi	4.0 bar	58 psi	
	km/h	mph	kg	lbs	kg	lbs	kg	lbs	kg	lbs	kg	lbs	kg	lbs	kg	lbs	kg	lbs	kg	lbs
Field	10	5	4 780	10 540	5 860	12 920	7 200	15 875	8 100	17 855	9 300	20 505	10 450	23 040	11 100	24 470	12 100	26 675	13 150	28 990
	20	12.5	4 380	9 655	5 380	11 860	6 600	14 550	7 450	16 425	8 500	18 740	9 600	21 165	10 150	22 375	11 100	24 470	12 050	26 565
	25	15	4 200	9 260	5 140	11 330	6 350	14 000	7 150	15 765	8 150	17 965	9 200	20 280	9 750	21 495	10 600	23 370	11 550	25 465
	30	20	4 020	8 860	4 920	10 845	6 050	13 340	6 800	14 990	7 800	17 195	8 800	19 400	9 300	20 505	10 150	22 375	11 050	24 360
	40	25	3 620	7 980	4 420	9 745	5 440	11 995	6 150	13 560	7 050	15 540	7 900	17 415	8 400	18 520	9 150	20 170	9 950	21 935
Road	50	30	3 220	7 100	3 940	8 685	4 840	10 670	5 460	12 035	6 250	13 780	7 050	15 540	7 450	16 425	8 150	17 965	8 850	19 510
	65	40	2 650	5 840	3 250	7 165	4 000	8 820	4 500	9 920	5 150	11 355	5 800	12 785	6 150	13 560	6 700	14 770	7 300	16 095

LIMITED WARRANTY

READ OUR WARRANTIES ONLINE

Nokian Heavy Tyres limited warranty

Intuitu™ Sensor limited warranty

Extended warranty for users of the Intuitu mobile application

Go to nokiantyres.com/warrantyinfomation/ or click on the link in the Intuitu app.

Nokian Heavy Tyres' liability shall be limited to the aforesaid limited warranties and shall only be valid as stipulated in the limited warranties.

GENERAL TERMS OF DELIVERY

1. DEFINITIONS

1.1. The following definitions shall apply to these General Terms of Delivery and to any Agreement:

“Agreement” shall mean a signed document (including its appendices) referring to these General Terms of Delivery or to which these General Terms of Delivery are attached or any other agreement between the Parties concluded as stipulated in section 2.2.

“Buyer” shall mean a Party purchasing the Products.

“Force Majeure Event” shall mean events beyond the control of a Party which occur after the Agreement entered into force and which were not reasonably foreseeable at the time the Agreement entered into force and whose effects are not capable of being overcome without unreasonable expense and/or loss of time to the Party concerned. Events of Force Majeure will include (without being limited to) epidemic, pandemic, war, civil unrest, strikes, lockouts and other general labour disputes, acts of government, natural disasters, exceptional weather conditions, breakdown or general unavailability of transport facilities, accidents, fire, flood, explosions and general shortages of

energy.

“Intellectual Property Rights” shall mean patents (including petty patents and utility models), design patents, and designs (whether or not capable of registration), copyright, trademark, service mark, and any other form of statutory or common law intellectual property protection of any kind; and applications for any of the foregoing including without limitation reissues, divisions, or other continuations thereof, in all jurisdictions, where applicable.

“Party” shall mean either Nokian Tyres or the Buyer.

“Products” shall mean tires, tire sensors, studs and anti-slip devices, or other products developed and manufactured by or for Nokian Tyres. The Products shall be those specified in the Agreement or those agreed between the Parties from time to time.

“Nokian Tyres” shall mean Nokian Tyres plc and any of its affiliate companies.

“Restricted Person” shall mean a person, organization or entity that is:

(i) listed on a sanctions list, including but not limited to “Specifically Designated Nationals and Blocked Persons” maintained by OFAC in U.S., “Consolidated List of Financial Sanctions Targets in the UK” maintained by HMT in UK; (ii) located or resident in or incorporated under the laws of a country or territory that is, or whose government is, the target of a country-wide or territory-wide Trade Restriction; (iii) owned or controlled by a Restricted Person; or (iv) otherwise a target of a Trade Restriction.

“Trade Restrictions” shall mean export and import laws, orders, and licenses, embargoes, sanctions of an economic, commercial or financial nature, regulations on sectors subject to restrictions (such as use for military purposes), regulations concerning Restricted Persons and other restrictive measures of similar nature, as existing, amended, supplemented and substituted from time to time, administrated, enacted or enforced by United Nations, United States of America (including OFAC), European Union or any of its member states, countries of European Economic Area, United Kingdom (including HTM), any other competent jurisdiction or any competent authority of the above. Trade Restrictions also include any other restrictions that may have any direct or indirect impact of any nature on Nokian Tyres or its subsidiaries irrespective of the

country/government/ authority by which the Trade Restriction is administered, enacted or enforced.

2. ENTRY INTO FORCE OF AGREEMENT

2.1. The Agreement enters into force when signed by both Parties.

2.2. The Agreement enters also into force when the Buyer accepts in writing Nokian Tyres's tender regarding the delivery of the Products or when Nokian Tyres accepts the Buyer's purchase order regarding the delivery of the Products in writing or by delivering the Products specified in such purchase order.

2.3. No Buyer's terms in Buyer's request for tender, purchase order or any other document will form part of the Agreement unless specifically approved in writing by Nokian Tyres. The Buyer expressly waives any right to rely on such terms.

3. PRODUCTS AND SERVICES

3.1. Nokian Tyres reserves the right to apply quantity limits on any purchase order, to reject all or part of a purchase order, and to discontinue or make changes to Products without notice, even if Buyer has already placed a purchase order. Also,

even if a purchase order has been accepted, Nokian Tyres may subsequently cancel such purchase order in whole or in part due to product unavailability (including without limitation, any discontinuation of the Product).

3.2. Nokian Tyres may offer ancillary services related to the Products such as mobile applications for tire monitoring. Services are subject to separate terms and conditions with which Buyer undertakes to comply when using the services.

4. DELIVERY

4.1. The delivery term of the Products shall be FCA, premises named by Nokian Tyres (Incoterms 2020), unless otherwise agreed by the Parties.

4.2. The Buyer shall inspect the Products after the delivery. The delivery shall be deemed accepted if the Buyer has not presented Nokian Tyres with a written remark regarding the delivery of the Products within seven (7) days from the delivery date.

4.3. Nokian Tyres shall deliver the Products at the agreed time of delivery. If the time of delivery has not been agreed in writing, Nokian Tyres shall deliver the Products within a reasonable time from the entry into force of the Agreement provided that the Products are available or, if the Products are not available, within a reasonable

time after they become available. Even though Nokian Tyres agrees to take all commercially reasonable measures to meet the agreed delivery dates, the Buyer acknowledges and agrees that Nokian Tyres shall not be liable for its failure to meet the agreed delivery dates.

4.4. If Nokian Tyres has outstanding due receivables from the Buyer, Nokian Tyres has the right to refrain from delivering the Products until the Buyer has settled the due payments in full. In such an event, the agreed delivery time will be extended correspondingly.

4.5. Nokian Tyres shall be entitled to make also partial deliveries.

5. PRICE AND TERMS OF PAYMENT

5.1. The prices of the Products have been agreed in the Agreement. Unless otherwise agreed in writing, Nokian Tyres' price list in force at the time of entry into force of the Agreement shall be applied. Nokian Tyres can issue changes to applicable price lists with a prior notice of one (1) month. Prices do not include any value added or similar taxes, which shall be added to all prices according to the laws and regulations in force at the time of the delivery. All Products shall be invoiced and payments made in Euro currency (EUR).

5.2. When the amount of or basis for taxes or other public payments changes before the delivery of the Products, either due to regulation change or change in the practice, Nokian Tyres has the right to adjust the prices of the Products correspondingly.

5.3. Unless otherwise stipulated by Nokian Tyres in writing, any offer issued by Nokian Tyres to the Buyer is valid for three (3) months from the date of issuance of the offer.

5.4. Unless otherwise agreed in writing, the Products will be invoiced after the date of delivery. Payment shall be due within thirty (30) days of the date of the invoice. The Buyer is obliged to pay eleven and a half (11.5) percent of annual interest on overdue payments beginning from the due date.

5.5. If Nokian Tyres has agreed to grant credit to the Buyer for the payment of the Products, Buyer is upon Nokian Tyres' request obliged to provide Nokian Tyres all necessary financial information (including but not limited to financial statements of the company) that is needed to grant the credit and assess the creditworthiness of the Buyer during the credit period. The obligation to provide financial information to Nokian Tyres continues as long as there is any open credit i.e. unpaid receivables from Buyer. For sake of clarity, the granting of any credit is at the sole discretion of Nokian Tyres and subject to a separate

decision made by Nokian Tyres.

6. TRANSFER OF RISK AND TITLE

6.1. Products delivered shall remain, to the extent permitted by applicable law, the property of Nokian Tyres until the Buyer has paid the price of the Products and the value added or similar taxes related to the respective Products. The Buyer shall give Nokian Tyres all necessary assistance in taking any measures to protect Nokian Tyres' title to the Products.

6.2. Until the title to the Products passes to the Buyer in accordance with Section 5.1 above, the Buyer shall store the Products at no costs to Nokian Tyres separately from all other products in its possession and mark the Products so that they are clearly identified as Nokian Tyres' property.

6.3. Notwithstanding the fact that the Products remain the property of Nokian Tyres, the Buyer may sell or use the Products in the ordinary course of the Buyer's business at full market value for the account of Nokian Tyres. Any such sale or use shall be a sale or use of Nokian Tyres' property by the Buyer and the Buyer shall act as the principal when making such sales or dealings. Until the title to the Products passes from Nokian Tyres to the Buyer, the entire proceeds from the sale or other dealings of the Products shall be

held in trust for Nokian Tyres and shall not be mixed with other money or paid into any overdrawn bank account of the Buyer and shall be at all times identified as Nokian Tyres' money. Also, until the title to the Products passes from Nokian Tyres to the Buyer, the Buyer shall assign its outstanding claims arising from the resale of the Products to Nokian Tyres as a security for Nokian Tyres' claims.

6.4. Until the title to the Products passes from Nokian Tyres to the Buyer, the Buyer shall upon Nokian Tyres' request return the delivered and unsold Products to Nokian Tyres. If the Buyer fails to do so, Nokian Tyres may enter upon any premises owned or occupied or controlled by the Buyer where the Products are supposed to be situated and repossess the Products. Upon such repossession, the rights of the Buyer under the Agreement with respect to the Products in question shall terminate.

6.5. The Buyer shall not pledge any of the Products which are still owned by Nokian Tyres. Without prejudice to any other rights of Nokian Tyres, if the Buyer does so, all sums whatsoever owed by the Buyer to Nokian Tyres shall become immediately due and payable.

6.6. The Buyer shall insure and keep insured the Products to their full market value against all risks to the reasonable satisfaction of Nokian Tyres until the date when the title to the Products

passes from Nokian Tyres to the Buyer, and shall whenever requested by Nokian Tyres produce a copy of the respective insurance policy. Without prejudice to the other rights of Nokian Tyres, if the Buyer fails to do so, all sums whatsoever owed by the Buyer to Nokian Tyres shall become immediately due and payable.

6.7. Notwithstanding the fact that the title to the Products shall remain with Nokian Tyres in accordance with the above provisions, the risk of damage or loss of the Products shall pass to the Buyer at the following times: (a) in the case the Products are to be delivered at Nokian Tyres's premises, at the time when Nokian Tyres notifies the Buyer that the Products are available for collection; or (b) in the case the Products are to be delivered otherwise than at Nokian Tyres's premises, at the time determined in the applicable delivery term.

7. WARRANTIES

7.1. Nokian Tyres' warranty terms concerning the Products are set out in Nokian Heavy Tyres' limited warranty terms valid at the time of the delivery. EXCEPT AS SET FORTH IN SUCH WARRANTY TERMS, THERE ARE NO OTHER EXPRESS OR IMPLIED WARRANTIES, INCLUDING BUT NOT LIMITED TO ANY IMPLIED WARRANTIES OF MERCHANTABILITY OR FITNESS FOR A PARTICULAR PURPOSE. To the maximum extent permitted by the applicable law, Nokian Tyres

shall have no other obligations or liabilities with respect to any possible defect or deficiency in the Products delivered hereunder than as set forth in the above- mentioned warranty terms.

8. LIABILITY AND CLAIMS

8.1. To the extent permitted by the applicable law, under no circumstances shall Nokian Tyres' liability under this Agreement exceed the invoice price of any Products with respect to which a claim is made.

8.2. Under no circumstances shall Nokian Tyres be liable under this Agreement for any indirect or consequential damage or loss, including without limitation any increased costs or expenses, or loss of profit, business, contracts, revenues or anticipated savings.

8.3. When Nokian Tyres has expressly agreed with the Buyer on the return of any of the delivered Products to Nokian Tyres, the Buyer assumes full responsibility for ensuring that the Products are placed in Nokian Tyres' possession. Nokian Tyres shall not accept any liability for any loss of any Products in transit.

8.4. The Buyer acknowledges and agrees to that any data generated by Nokian Tyres' digital services regarding the use of Products can be used in processing of claims made by the Buyer towards Nokian Tyres.

9. SPECIFICATIONS AND INTELLECTUAL PROPERTY RIGHTS

9.1. The weights, dimensions, capacities, prices, performance ratings and other data included in catalogues, prospectuses, circulars, advertisements and price lists and other similar information regarding the Products, as expressed in Nokian Tyres' general product information, constitute an approximate guide. This data shall not be binding on Nokian Tyres, save to the extent that it is by reference expressly included in the Agreement.

9.2. No right or license is granted under the Agreement to the Buyer under any patent, trademark, copyright, registered design or other Intellectual Property Rights, except for the right to use or resell the Products.

9.3. All Products sold in retail packaging may be resold by the Buyer only in the packaging supplied by Nokian Tyres and in no case may any trademark other than those applied by Nokian Tyres be marked on or applied in relation to the Products.

10. CONFIDENTIALITY

10.1. The Buyer undertakes to keep confidential all terms and conditions of the Agreement and its appendices, as well as all information given on

Nokian Tyres' or its business partners' operations, products and services and any information regarded as trade secrets of Nokian Tyres. The Buyer shall not (and shall secure that its directors, agents and employees shall not) be entitled at any time without prior written consent of Nokian Tyres to disclose Nokian Tyres' confidential information to any third party or to use it whether directly or indirectly for other purposes than in accordance with the Agreement. The obligation of confidentiality shall survive the termination of the Agreement and remain in force for five (5) years thereafter.

10.2. The Section 10.1 shall not apply to any information which (i) the receiving Party can prove to have been in its possession at the date of receipt or (ii) which is or becomes public knowledge otherwise than through a breach of an obligation of confidentiality.

11. INTEGRITY AND CODE OF CONDUCT

11.1. The Nokian Tyres' Code of Conduct applies to the business relationship between the parties (available at Nokian Tyres' webpages). The Buyer agrees to comply with the principles set out therein, as amended from time to time. 11.2. The Buyer further warrants that the Buyer or any individuals or entities acting for or on behalf of the Buyer have not violated any applicable laws and regulations related to anti-trust and

competition, anti-corruption or money laundering and warrants that applicable anti-trust and competition, anti-corruption or money laundering laws and regulations are complied with in all its activities.

12. DATA PRIVACY

12.1. As a part of the cooperation under the Agreement, Nokian Tyres may collect and processes personal data about the representatives of the Buyer. Nokian Tyres processes the personal data in accordance with applicable data protection legislation. More information about for what purposes and how personal data is collected and processed by Nokian Tyres is available in Nokian Tyres' Privacy Statement, which is available at <https://www.nokiantyres.com/privacy-statement/>.

12.2. Unless otherwise agreed, the cooperation under the Agreement does not include any processing of personal data by one party on behalf of the other party, or any sharing or disclosure of personal data, and the parties agree that each party is independently responsible for complying with applicable data protection legislation with regard to the personal data they may process.

12.3. If the cooperation under the Agreement would include disclosing personal data from one party to another, but no party processes personal

data on behalf of the other party, the original controller of the personal data shall be responsible for ensuring that there is a legal basis for such disclosure.

13. TRADE RESTRICTIONS AND IMPORT/EXPORT CONTROLS

13.1. The Buyer warrants that it will comply in all respects with any Trade Restrictions for every Product delivered to the Buyer. The Buyer also assures that other individuals or entities acting for or on behalf of the Buyer comply with the Trade Restrictions.

13.2. The Buyer warrants that neither it nor any other Buyer belonging to same group of companies, nor any owner, beneficial owner, member of their board of directors nor any of their managing director nor any other director, employee, agent or representative or of any member of the group is currently a Restricted Person or have ever been a Restricted Person. The Buyer undertakes to inform Nokian Tyres without delay if any person or Buyer mentioned above shall become subject to a Trade Restriction.

13.3. Accordingly, the Buyer undertakes:

a) to obtain, at its own expense, any licenses, shipping documents and authorizations or

approvals to export or import the Products as may be required; and

b) not to advertise, market, promote, sell, lease or otherwise transfer the purchased Products to Restricted Person or to restricted countries/areas subject to Trade Restriction; and

c) not to advertise, market, promote, sell, lease or otherwise transfer the purchased Products for the purpose of using them in restricted sectors, insofar as the transfer is restricted according to a Trade Restriction and insofar as a license or approval has not been obtained; and

d) to comply with any applicable Trade Restrictions with regard to issuance of payments and finance associated with the Products.

13.4. The Buyer shall indemnify Nokian Tyres and hold Nokian Tyres harmless from and against any damages, liabilities or costs resulting from the Buyer's violation or alleged violation of the Trade Restrictions.

13.5. Nokian Tyres retains the right to cancel or delay delivery of any Product at any time without penalty or liability of any nature, as, at the sole discretion of Nokian Tyres, required with respect to a Trade Restrictions. The delivery may be delayed until a license, approval or similar is granted or for the duration of the restriction. If

purchased Products are transferred in violation of the Trade Restrictions, Nokian Tyres shall not be obligated to provide any warranty for the Products transferred.

13.6. Nokian Tyres is, at their sole discretion, also entitled to terminate the Agreement with immediate effect without penalty or liability of any nature if a delivery of any Product or any other performance of either Party under the Agreement may result in violation of any Trade Restriction.

13.7. Nokian Tyres shall be entitled to audit the Buyer's compliance with obligations relating to these matters. The Buyer shall supply on request all necessary information to verify compliance.

13.8. As a customer of Nokian Tyres, the Buyer may have been required to provide certain information of the Buyer to Nokian Tyres in accordance with Nokian Tyres' client onboarding process before the signing of this Agreement. The Buyer undertakes to inform Nokian Tyres immediately if there are any changes to the information provided as part of Nokian Tyres' customer onboarding process.

14. TERM AND TERMINATION

14.1. The Agreement shall be in full force and effect (i) until Parties' obligations under the

Agreement have been fulfilled or (ii) in case of a continuous agreement until terminated by either party for any reason with at least three (3) months prior written notice. Termination of a continuous Agreement in accordance with this section 14.1 shall not relieve neither Party from any obligations related to orders accepted before termination.

14.2. The Agreement may be terminated with immediate effect by the non-defaulting Party with a written notice to the other Party in the event that (a) the other Party commits a material breach of the Agreement and fails to remedy such breach (if capable of being remedied) within thirty (30) days after having been notified thereof in writing; or (b) the other Party commits an act of bankruptcy, is placed in liquidation or becomes otherwise incapable of fulfilling its financial obligations under the Agreement, or should it become apparent that any of the above occurrences shall take place.

14.3. Furthermore, the Agreement may be terminated with immediate effect with a written notice by Nokian Tyres to the Buyer in the event that (a) there is a direct or indirect change of ownership or control or other substantial change in the management, staff or the business operations of the Buyer which may adversely affect achieving the purpose of the Agreement; (b) Buyer violates any of its obligations under sections 9, 10, 11, 12 or 13; or (c) the Buyer enters

into an agreement with a third party or engages itself in any activity which prejudices the confidentiality of Nokian Tyres' confidential material or information.

14.4. Upon termination of the Agreement due to the Buyer's breach, Nokian Tyres shall have the right to do one or more of the following: (a) revoke any express or implied authority to sell, resell, use or consume any Products whose title has not passed to the Buyer and re-sell such Products; (b) suspend any deliveries to be made under any agreement with the Buyer; and/or (c) make claim against the Buyer for the price of the unpaid Products and/ or damages.

15. OTHER TERMS

15.1. In case of conflict, the Agreement shall take precedence over these General Terms of Delivery, and these General Terms of Delivery shall take precedence over any other appendices of the Agreement.

15.2. The Agreement constitutes the entire agreement between the parties with respect to the subject matter and supersedes all other prior agreements and understandings, both written and oral, between the parties with respect to the subject matter.

15.3. Neither Party shall be liable to the other Party for any delay or non-performance of its

obligations under the Agreement in the event and to the extent that such delay or non-performance is due to an Force Majeure Event.

15.4. The Agreement and these General Terms of Delivery shall be construed and enforced in accordance with the laws of Finland, excluding its choice of law provisions and Convention on Contracts for the International Sale of Goods (CISG). Any dispute, controversy or claim arising out of or relating to the Agreement, or the breach, termination or validity thereof, shall be finally settled in arbitration by one (1) arbitrator in accordance with the Arbitration Rules of the Central Chamber of Commerce of Finland. The arbitration shall be conducted in Helsinki.