



# TECHNICAL MANUAL

UPDATED: 2026-04-11

NOKIAN HEAVY TYRES

**nokian**<sup>®</sup>  
**TYRES**

# TABLE OF CONTENTS

|                                                        |           |                                                                                            |            |
|--------------------------------------------------------|-----------|--------------------------------------------------------------------------------------------|------------|
| <b>GENERAL INFO</b>                                    | <b>3</b>  | <b>TIRE CHOICE AND INFLATION PRESSURES BY 40 APPLICATION</b>                               |            |
| <b>TIRE MARKINGS</b>                                   | <b>4</b>  | <b>GROUND CONTACT PRESSURE COMPARISON</b>                                                  | <b>86</b>  |
| <b>TIRE STRUCTURES</b>                                 | <b>11</b> | <b>CONTACT AREAS ON A HARD DRIVING SURFACE</b>                                             | <b>92</b>  |
| <b>INFLATION PRESSURE</b>                              | <b>12</b> | <b>STUDS AND CHAINS</b>                                                                    | <b>95</b>  |
| <b>LIQUID AND SALT BALLASTING</b>                      | <b>14</b> | <b>MPT AGILE STUD RECOMMENDATIONS</b>                                                      | <b>99</b>  |
| <b>TRACTOR AND LOADER TIRES FOR WINTER APPLICATION</b> | <b>15</b> | <b>MOUNTING TIRES ON FOUR WHEEL DRIVE TRACTORS</b>                                         | <b>100</b> |
| <b>NON-SKID CHAINS</b>                                 | <b>17</b> | <b>MINE TIRE MAINTENANCE</b>                                                               | <b>102</b> |
| <b>TRACKS</b>                                          | <b>18</b> | <b>HAKKAPELIITTA LOADER INFLATION PRESSURE RECOMMENDATIONS FOR DIFFERENT WHEEL LOADERS</b> | <b>103</b> |
| <b>RIMS</b>                                            | <b>19</b> | <b>GROUND KARE AND EXCAVATOR MOUNTING RECOMMENDATIONS</b>                                  | <b>106</b> |
| <b>RIM MARKINGS</b>                                    | <b>20</b> | <b>NOKIAN TYRES INTUITU™ SMART TIRES</b>                                                   | <b>108</b> |
| <b>WHEEL STUD HOLES AND COUNTERSINKS</b>               | <b>21</b> | <b>REGROOVING OF NOKIAN TYRES TRUCK AND BUS TIRES</b>                                      | <b>111</b> |
| <b>RIM CONTOURS</b>                                    | <b>25</b> | <b>REGROOVING RECOMMENDATIONS</b>                                                          | <b>112</b> |
| <b>WHEEL MAIN DIMENSIONS</b>                           | <b>26</b> | <b>STUDDING OF NOKIAN TYRES</b>                                                            | <b>115</b> |
| <b>WHEEL PARTS / COMPONENTS</b>                        | <b>27</b> | <b>HAKKAPELIITTA TRUCK BRANDED TIRES</b>                                                   |            |
| <b>FORESTRY RIMS</b>                                   | <b>28</b> | <b>AREAS OF USE AND EU LABEL INFO</b>                                                      | <b>116</b> |
| <b>KNURLING</b>                                        | <b>29</b> | <b>HOW TO USE LOAD CAPACITY TABLES</b>                                                     | <b>118</b> |
| <b>TUBELESS FORESTRY RIMS</b>                          | <b>30</b> | <b>LIMITED WARRANTY</b>                                                                    | <b>120</b> |
| <b>INDUSTRIAL AND EM MULTI-PIECE WHEELS</b>            | <b>31</b> | <b>GENERAL TERMS OF DELIVERY</b>                                                           | <b>121</b> |
| <b>FLAPS AND O-RINGS</b>                               | <b>33</b> |                                                                                            |            |
| <b>INSPECTIONS ON RIMS</b>                             | <b>36</b> |                                                                                            |            |
| <b>TIRE MOUNTING CLAMPS</b>                            | <b>37</b> |                                                                                            |            |
| <b>TUBES AND VALVES</b>                                | <b>39</b> |                                                                                            |            |

# GENERAL INFO

Nokian Heavy Tyres is passionate in developing high quality solutions for the most extreme conditions found in forests, modern day farming, municipal contracting, transportation terminals and underground applications. In addition to tire and supplementary item information, this manual focuses on the special necessities and requirements in each product category. The forestry section, for example, has a detailed guide on the right tire and inflation pressure choice by application. This technical manual will be your tool in finding the right tire for your work, with a promise on carefree working hours.

# TIRE MARKINGS



## TIRE CLASSIFICATION CODES

### OPTIONAL MARKING

| TRA Code                                                                | Tread type                                    |
|-------------------------------------------------------------------------|-----------------------------------------------|
| <b>Agricultural tractor drive wheel tires</b>                           |                                               |
| R-1                                                                     | Regular service (tread)                       |
| R-1W                                                                    | Wet traction service                          |
| R-1S                                                                    | Sprayer / spreader service                    |
| R-2                                                                     | Cane and rice service (deep tread)            |
| R-3                                                                     | Flotation service (shallow tread)             |
| R-4                                                                     | Industrial service (construction application) |
| <b>Agricultural tractor steering wheel tires (non-traction pattern)</b> |                                               |
| F-1                                                                     | Single rib tread                              |
| F-2                                                                     | Multiple rib tread                            |
| F-3                                                                     | Industrial service (construction application) |
| <b>Agricultural implement tires</b>                                     |                                               |
| I-1                                                                     | Multi-rib tread                               |
| I-2                                                                     | Moderate traction service                     |
| I-3                                                                     | Traction tread                                |
| I-4                                                                     | Plough tail wheel service                     |
| I-5                                                                     | Steering service                              |
| I-6                                                                     | Smooth tread                                  |
| <b>Garden tractor tires (implement tires)</b>                           |                                               |
| G-1                                                                     | Traction service                              |
| G-2                                                                     | Flotation traction service                    |
| G-3                                                                     | Maximum flotation service                     |

| TRA Code                                                     | Tread type         |
|--------------------------------------------------------------|--------------------|
| <b>Grader tires (Motor graders)</b>                          |                    |
| G-2                                                          | Traction regular   |
| G-3                                                          | Rock regular       |
| <b>Logging and forestry service tires</b>                    |                    |
| LS-1                                                         | Regular tread      |
| LS-2                                                         | Intermediate tread |
| LS-3                                                         | Deep tread         |
| LS-4                                                         | Shallow tread      |
| <b>High flotation tires for off-the-road service</b>         |                    |
| HF-1                                                         | Shallow tread      |
| HF-2                                                         | Regular tread      |
| HF-3                                                         | Deep tread         |
| HF-4                                                         | Extra deep tread   |
| <b>Earthmover tires (Dump trucks and scrapers)</b>           |                    |
| E-1                                                          | Rib regular        |
| E-2                                                          | Traction regular   |
| E-3                                                          | Rock regular       |
| E-4                                                          | Rock deep tread    |
| E-7                                                          | Flotation          |
| <b>Loader and dozer tires (Front-end loaders and dozers)</b> |                    |
| L-2                                                          | Traction regular   |
| L-3                                                          | Rock regular       |
| L-4                                                          | Rock deep tread    |

| TRA Code                                                                                                     | Tread type              |
|--------------------------------------------------------------------------------------------------------------|-------------------------|
| L-5                                                                                                          | Rock extra deep tread   |
| L-4S                                                                                                         | Smooth deep tread       |
| L-5S                                                                                                         | Smooth extra deep tread |
| <b>Compactor tires</b>                                                                                       |                         |
| C-1                                                                                                          | Smooth                  |
| <b>Industrial tires (Straddle carriers, transfer cranes, towing tractors, reach stackers and fork lifts)</b> |                         |
| IND-3                                                                                                        | Traction regular        |
| IND-4                                                                                                        | Deep tread              |
| IND-5                                                                                                        | Extra deep tread        |

**Notice!** TRA = Tire and Rim Association Inc.

## LOAD INDEX

THE LOAD INDEX (LI) IS A NUMERICAL CODE ASSOCIATED WITH THE MAXIMUM LOAD A TIRE CAN CARRY.

| LI | kg   | LI | kg   | LI | kg  | LI | kg  | LI  | kg    | LI  | kg    | LI  | kg    | LI  | kg    | LI  | kg     | LI  | kg     | LI  | kg     | LI  | kg     | LI  | kg      |
|----|------|----|------|----|-----|----|-----|-----|-------|-----|-------|-----|-------|-----|-------|-----|--------|-----|--------|-----|--------|-----|--------|-----|---------|
| 0  | 45   | 22 | 85   | 44 | 160 | 66 | 300 | 88  | 560   | 110 | 1 060 | 132 | 2 000 | 154 | 3 750 | 176 | 7 100  | 198 | 13 200 | 220 | 25 000 | 242 | 47 500 | 264 | 90 000  |
| 1  | 46.2 | 23 | 87.5 | 45 | 165 | 67 | 307 | 89  | 580   | 111 | 1 090 | 133 | 2 060 | 155 | 3 875 | 177 | 7 300  | 199 | 13 600 | 221 | 25 750 | 243 | 48 750 | 265 | 92 500  |
| 2  | 47.5 | 24 | 90   | 46 | 170 | 68 | 315 | 90  | 600   | 112 | 1 120 | 134 | 2 120 | 156 | 4 000 | 178 | 7 500  | 200 | 14 000 | 222 | 26 500 | 244 | 50 000 | 266 | 95 000  |
| 3  | 48.7 | 25 | 92.5 | 47 | 175 | 69 | 325 | 91  | 615   | 113 | 1 150 | 135 | 2 180 | 157 | 4 125 | 179 | 7 750  | 201 | 14 500 | 223 | 27 250 | 245 | 51 500 | 267 | 97 500  |
| 4  | 50   | 26 | 95   | 48 | 180 | 70 | 335 | 92  | 630   | 114 | 1 180 | 136 | 2 240 | 158 | 4 250 | 180 | 8 000  | 202 | 15 000 | 224 | 28 000 | 246 | 53 000 | 268 | 100 000 |
| 5  | 51.5 | 27 | 97.5 | 49 | 185 | 71 | 345 | 93  | 650   | 115 | 1 215 | 137 | 2 300 | 159 | 4 375 | 181 | 8 250  | 203 | 15 500 | 225 | 29 000 | 247 | 54 500 | 269 | 103 000 |
| 6  | 53   | 28 | 100  | 50 | 190 | 72 | 355 | 94  | 670   | 116 | 1 250 | 138 | 2 360 | 160 | 4 500 | 182 | 8 500  | 204 | 16 000 | 226 | 30 000 | 248 | 56 000 | 270 | 106 000 |
| 7  | 54.5 | 29 | 193  | 51 | 195 | 73 | 365 | 95  | 690   | 117 | 1 285 | 139 | 2 430 | 161 | 4 625 | 183 | 8 750  | 205 | 16 500 | 227 | 30 750 | 249 | 58 000 | 271 | 109 000 |
| 8  | 56   | 30 | 106  | 52 | 200 | 74 | 375 | 96  | 710   | 118 | 1 320 | 140 | 2 500 | 162 | 4 750 | 184 | 9 000  | 206 | 17 000 | 228 | 31 500 | 250 | 60 000 | 272 | 112 000 |
| 9  | 58   | 31 | 109  | 53 | 206 | 75 | 387 | 97  | 730   | 119 | 1 360 | 141 | 2 575 | 163 | 4 875 | 185 | 9 250  | 207 | 17 500 | 229 | 32 500 | 251 | 61 500 | 273 | 115 000 |
| 10 | 60   | 32 | 112  | 54 | 212 | 76 | 400 | 98  | 750   | 120 | 1 400 | 142 | 2 650 | 164 | 5 000 | 186 | 9 500  | 208 | 18 000 | 230 | 33 500 | 252 | 63 000 | 274 | 118 000 |
| 11 | 61.5 | 33 | 115  | 55 | 218 | 77 | 412 | 99  | 775   | 121 | 1 450 | 143 | 2 725 | 165 | 5 150 | 187 | 9 750  | 209 | 18 500 | 231 | 34 500 | 253 | 65 000 | 275 | 121 000 |
| 12 | 63   | 34 | 118  | 56 | 224 | 78 | 425 | 100 | 800   | 122 | 1 500 | 144 | 2 800 | 166 | 5 300 | 188 | 10 000 | 210 | 19 000 | 232 | 35 500 | 254 | 67 000 | 276 | 125 000 |
| 13 | 65   | 35 | 121  | 57 | 230 | 79 | 437 | 101 | 825   | 123 | 1 550 | 145 | 2 900 | 167 | 5 450 | 189 | 10 300 | 211 | 19 500 | 233 | 36 500 | 255 | 69 000 | 277 | 128 500 |
| 14 | 67   | 36 | 125  | 58 | 236 | 80 | 450 | 102 | 850   | 124 | 1 600 | 146 | 3 000 | 168 | 5 600 | 190 | 10 600 | 212 | 20 000 | 234 | 37 500 | 256 | 71 000 | 278 | 132 000 |
| 15 | 69   | 37 | 128  | 59 | 243 | 81 | 462 | 103 | 875   | 125 | 1 650 | 147 | 3 075 | 169 | 5 800 | 191 | 10 900 | 213 | 20 600 | 235 | 38 750 | 257 | 73 000 | 279 | 136 000 |
| 16 | 71   | 38 | 132  | 60 | 250 | 82 | 475 | 104 | 900   | 126 | 1 700 | 148 | 3 150 | 170 | 6 000 | 192 | 11 200 | 214 | 21 200 | 236 | 40 000 | 258 | 75 000 |     |         |
| 17 | 73   | 39 | 136  | 61 | 257 | 83 | 487 | 105 | 925   | 127 | 1 750 | 149 | 3 250 | 171 | 6 150 | 193 | 11 500 | 215 | 21 800 | 237 | 41 250 | 259 | 77 500 |     |         |
| 18 | 75   | 40 | 140  | 62 | 265 | 84 | 500 | 106 | 950   | 128 | 1 800 | 150 | 3 350 | 172 | 6 300 | 194 | 11 800 | 216 | 22 400 | 238 | 42 500 | 260 | 80 000 |     |         |
| 19 | 77.5 | 41 | 145  | 63 | 272 | 85 | 515 | 107 | 975   | 129 | 1 850 | 151 | 3 450 | 173 | 6 500 | 195 | 12 150 | 217 | 23 000 | 239 | 43 750 | 261 | 82 500 |     |         |
| 20 | 80   | 42 | 150  | 64 | 280 | 86 | 530 | 108 | 1 000 | 130 | 1 900 | 152 | 3 550 | 174 | 6 700 | 196 | 12 500 | 218 | 23 600 | 240 | 45 000 | 262 | 85 000 |     |         |
| 21 | 82.5 | 43 | 155  | 65 | 290 | 87 | 545 | 109 | 1 030 | 131 | 1 950 | 153 | 3 650 | 175 | 6 900 | 197 | 12 850 | 219 | 24 300 | 241 | 46 250 | 263 | 87 500 |     |         |

**Example:** 157 A8 a tire can carry maximum 4125 kg at the maximum speed of 40 km/h.

## UNITS

| Quantity | S.I. units         | Other units                                                      |
|----------|--------------------|------------------------------------------------------------------|
| Length   | m (metre)          | 1 inch (") = 0.0254 m (or 25.4 mm)                               |
|          |                    | 1 mile = 1 609 m (or 1.609 km)                                   |
| Mass     | kg (kilogram)      | 1 pound (lb) = 0.4536 kg                                         |
| Pressure | Pa (Pascal)        | 1 bar = 100 kPa                                                  |
|          |                    | 1 pound per square inch (psi or lb/in <sup>2</sup> ) = 6.895 kPa |
|          |                    | 1 kg/cm <sup>2</sup> = 98.066 kPa                                |
| Speed    | m/s                | 1 km per hour (km/h) = 0.277778 m/s                              |
|          | (metre per second) | 1 mile per hour (mph) = 0.4470 m/s (or 1.60935 km/h)             |

## PICTOGRAM

### MARKED ON BOTH TIRE SIDEWALLS

Expects the maximum inflation pressure not to be exceeded for bead seating during tire mounting. The value of inflation pressure (2.5 bar in the example) must be the same as specified by the tire manufacturer.



## Speed symbol

The SPEED SYMBOL (SS) indicates the maximum speed at which the tire can carry a load corresponding to its Load Index.

| SS | km/h | mph  |
|----|------|------|
| A1 | 5    | 2.5  |
| A2 | 10   | 5    |
| A3 | 15   | 10   |
| A4 | 20   | 12.5 |
| A5 | 25   | 15   |
| A6 | 30   | 20   |
| A7 | 35   | 22.5 |
| A8 | 40   | 25   |
| B  | 50   | 30   |
| C  | 60   | 35   |
| D  | 65   | 40   |
| E  | 70   | 43   |
| F  | 80   | 50   |
| G  | 90   | 55   |
| J  | 100  | 62   |
| K  | 110  | 68   |
| L  | 120  | 75   |
| M  | 130  | 81   |
| N  | 140  | 87   |
| P  | 150  | 93   |
| Q  | 160  | 99   |
| R  | 170  | 106  |
| S  | 180  | 112  |
| T  | 190  | 118  |

## LOW SPOT MARKING (UPON REQUEST)

This marking is used for match-mounting tires on agricultural tractor wheels equipped with a high spot marking.

In the tire industry, **low spot marking** refers to the identification and marking of the area on a tire that has the lowest radial runout, meaning the point where the tire's tread or sidewall is closest to the center of the wheel. This process is crucial for ensuring optimal tire balance and reducing vibrations when the tire is mounted on a vehicle.

Key Details:

- **Radial Runout:** Radial runout is the measurement of how much a tire's radius varies as it rotates. Ideally, the tire should be perfectly round, but manufacturing imperfections can cause slight variations.
- **Low Spot:** The low spot is the point on the tire where the distance from the tire's center (or hub) to the tread or sidewall is the shortest. This is identified using specialized equipment that measures the tire's geometry.
- **Marking:** Once the low spot is identified, it is marked with a white colored dot on the tire's sidewall. This marking helps technicians during the tire mounting process.
- **Tire and Wheel Matching:** The low spot marking is used in conjunction with the high spot marking on the wheel (the point where the wheel's radial runout is the greatest) to optimize the mounting process. By aligning the tire's low spot with the wheel's high spot, the overall radial runout is minimized, which leads to a smoother ride and better tire performance.

This practice is part of the tire and wheel balancing process and helps to ensure that the vehicle operates smoothly and that the tires wear evenly over time.



## PRESSURE UNIT, CONVERSION TABLE

| kPa | bar | * lbs/in <sup>2</sup> (psi) | * kg/cm <sup>2</sup> | kPa | bar | * lbs/in <sup>2</sup> (psi) | * kg/cm <sup>2</sup> | kPa | bar | * lbs/in <sup>2</sup> (psi) | * kg/cm <sup>2</sup> | kPa | bar | * lbs/in <sup>2</sup> (psi) | * kg/cm <sup>2</sup> | kPa  | bar  | * lbs/in <sup>2</sup> (psi) | * kg/cm <sup>2</sup> |
|-----|-----|-----------------------------|----------------------|-----|-----|-----------------------------|----------------------|-----|-----|-----------------------------|----------------------|-----|-----|-----------------------------|----------------------|------|------|-----------------------------|----------------------|
| 10  | 0.1 | 1                           | 0.1                  | 230 | 2.3 | 33                          | 2.3                  | 450 | 4.5 | 65                          | 4.6                  | 670 | 6.7 | 97                          | 6.8                  | 890  | 8.9  | 129                         | 9.1                  |
| 20  | 0.2 | 3                           | 0.2                  | 240 | 2.4 | 35                          | 2.4                  | 460 | 4.6 | 67                          | 4.7                  | 680 | 6.8 | 99                          | 6.9                  | 900  | 9.0  | 131                         | 9.2                  |
| 30  | 0.3 | 4                           | 0.3                  | 250 | 2.5 | 36                          | 2.5                  | 470 | 4.7 | 68                          | 4.8                  | 690 | 6.9 | 100                         | 7.0                  | 910  | 9.1  | 132                         | 9.3                  |
| 40  | 0.4 | 6                           | 0.4                  | 260 | 2.6 | 38                          | 2.7                  | 480 | 4.8 | 70                          | 4.9                  | 700 | 7.0 | 102                         | 7.1                  | 920  | 9.2  | 133                         | 9.4                  |
| 50  | 0.5 | 7                           | 0.5                  | 270 | 2.7 | 39                          | 2.8                  | 490 | 4.9 | 71                          | 5.0                  | 710 | 7.1 | 103                         | 7.2                  | 930  | 9.3  | 135                         | 9.5                  |
| 60  | 0.6 | 9                           | 0.6                  | 280 | 2.8 | 41                          | 2.9                  | 500 | 5.0 | 73                          | 5.1                  | 720 | 7.2 | 104                         | 7.3                  | 940  | 9.4  | 136                         | 9.6                  |
| 70  | 0.7 | 10                          | 0.7                  | 290 | 2.9 | 42                          | 3.0                  | 510 | 5.1 | 74                          | 5.2                  | 730 | 7.3 | 106                         | 7.4                  | 950  | 9.5  | 138                         | 9.7                  |
| 80  | 0.8 | 12                          | 0.8                  | 300 | 3.0 | 44                          | 3.1                  | 520 | 5.2 | 75                          | 5.3                  | 740 | 7.4 | 107                         | 7.5                  | 960  | 9.6  | 139                         | 9.8                  |
| 90  | 0.9 | 13                          | 0.9                  | 310 | 3.1 | 45                          | 3.2                  | 530 | 5.3 | 77                          | 5.4                  | 750 | 7.5 | 109                         | 7.6                  | 970  | 9.7  | 141                         | 9.9                  |
| 100 | 1.0 | 15                          | 1.0                  | 320 | 3.2 | 46                          | 3.3                  | 540 | 5.4 | 78                          | 5.5                  | 760 | 7.6 | 110                         | 7.7                  | 980  | 9.8  | 142                         | 10.0                 |
| 110 | 1.1 | 16                          | 1.1                  | 330 | 3.3 | 48                          | 3.4                  | 550 | 5.5 | 80                          | 5.6                  | 770 | 7.7 | 112                         | 7.9                  | 990  | 9.9  | 144                         | 10.1                 |
| 120 | 1.2 | 17                          | 1.2                  | 340 | 3.4 | 49                          | 3.5                  | 560 | 5.6 | 81                          | 5.7                  | 780 | 7.8 | 113                         | 8.0                  | 1000 | 10.0 | 145                         | 10.2                 |
| 130 | 1.3 | 19                          | 1.3                  | 350 | 3.5 | 51                          | 3.6                  | 570 | 5.7 | 83                          | 5.8                  | 790 | 7.9 | 115                         | 8.1                  | 1010 | 10.1 | 146                         | 10.3                 |
| 140 | 1.4 | 20                          | 1.4                  | 360 | 3.6 | 52                          | 3.7                  | 580 | 5.8 | 84                          | 5.9                  | 800 | 8.0 | 116                         | 8.2                  | 1020 | 10.2 | 148                         | 10.4                 |
| 150 | 1.5 | 22                          | 1.5                  | 370 | 3.7 | 54                          | 3.8                  | 590 | 5.9 | 86                          | 6.0                  | 810 | 8.1 | 117                         | 8.3                  | 1030 | 10.3 | 149                         | 10.5                 |
| 160 | 1.6 | 23                          | 1.6                  | 380 | 3.8 | 55                          | 3.9                  | 600 | 6.0 | 87                          | 6.1                  | 820 | 8.2 | 119                         | 8.4                  | 1040 | 10.4 | 151                         | 10.6                 |
| 170 | 1.7 | 25                          | 1.7                  | 390 | 3.9 | 57                          | 4.0                  | 610 | 6.1 | 88                          | 6.2                  | 830 | 8.3 | 120                         | 8.5                  | 1050 | 10.5 | 152                         | 10.7                 |
| 180 | 1.8 | 26                          | 1.8                  | 400 | 4.0 | 58                          | 4.1                  | 620 | 6.2 | 90                          | 6.3                  | 840 | 8.4 | 122                         | 8.6                  | 1060 | 10.6 | 154                         | 10.8                 |
| 190 | 1.9 | 28                          | 1.9                  | 410 | 4.1 | 59                          | 4.2                  | 630 | 6.3 | 91                          | 6.4                  | 850 | 8.5 | 123                         | 8.7                  | 1070 | 10.7 | 155                         | 10.9                 |
| 200 | 2.0 | 29                          | 2.0                  | 420 | 4.2 | 61                          | 4.3                  | 640 | 6.4 | 93                          | 6.5                  | 860 | 8.6 | 125                         | 8.8                  | 1080 | 10.8 | 157                         | 11.0                 |
| 210 | 2.1 | 30                          | 2.1                  | 430 | 4.3 | 62                          | 4.4                  | 650 | 6.5 | 94                          | 6.6                  | 870 | 8.7 | 126                         | 8.9                  | 1090 | 10.9 | 158                         | 11.1                 |
| 220 | 2.2 | 32                          | 2.2                  | 440 | 4.4 | 64                          | 4.5                  | 660 | 6.6 | 96                          | 6.7                  | 880 | 8.8 | 128                         | 9.0                  | 1100 | 11.0 | 160                         | 11.2                 |

\* Values in psi and kg/cm2 rounded to the nearest practical unit.

## SIZE EQUIVALENCY

| mm dimension | Equivalent size |
|--------------|-----------------|
| 250/80R16    | 7.5R16          |
| 340/80R18    | 12.5R18         |
| 360/80R20    | 14.5R20         |
| 300/80R24    | 11.2R24         |
| 340/80R24    | 12.4R24         |
| 360/80R24    | 13.6R24         |
| 400/80R24    | 14.9R24         |
| 440/80R24    | 16.9R24         |
| 360/80R28    | 13.6R28         |
| 400/80R28    | 14.9R28         |
| 440/80R28    | 16.9R28         |
| 440/80R30    | 16.9R30         |
| 480/80R30    | 18.4R30         |
| 440/80R34    | 16.9R34         |
| 480/80R34    | 18.4R34         |
| 480/80R38    | 18.4R38         |
| 540/80R38    | 20.8R38         |
| 620/80R42    | N.A.            |
| 270/75R15    | N.A.            |
| 250/75R16    | N.A.            |
| 500/70R24    | 19.5LR24        |

# TIRE STRUCTURES



## RADIAL TIRE

The tire carcass is stabilized by an inextensible circumferential belt

The ply cords are laid substantially at 90° to the centerline of the tread



## DIAGONAL (OR BIAS PLY) TIRE

The ply cords are laid at alternate angles substantially less than 90° to the centerline of the tread



## BIAS BELTED

The tire carcass is stabilized by an inextensible circumferential belt

Tire structure of diagonal tire

# INFLATION PRESSURE

## CHOOSING THE RIGHT INFLATION PRESSURE

### MAINTAINING THE PROPER INFLATION PRESSURE

The inflation pressures of tires should be checked carefully at regular intervals. Perform a visual check daily and repeatedly when operating. A slow leak can cause damage to the tire sidewall or lead to tube failure before the under-inflation can be felt in the handling of the machine.

Repairable damage should be repaired immediately in order to help obtain regular tire life. When operating machinery in winter conditions, it should be kept in mind that when temperatures decrease, so do tire inflation pressures. Consequently, when inflating a tire indoors in winter, it should be inflated slightly over the recommended pressure. The diagram below should prove of assistance in determining the correct pressure.

### GROUND DISTURBANCE

Ground disturbance is more pronounced when operating in soft soil conditions. When the tire gets in contact with the ground on a hard surface, it is the tire that gets depressed, whereas when operating on soft soil, the ground gets depressed. The inflation pressure should be less than the ground pressure between the ground and the tire, in case approx. 55 kPa, for it to reduce the depth of the footprint.

Consequently, it is not advisable to reduce tire inflation pressures in order to improve the machine's footprint, as it has a negative impact on the tire's service life. The use of wider tires and tires with VF technology will serve this

### THE RELATIONSHIP BETWEEN TIRE INFLATION PRESSURE AND AIR TEMPERATURE

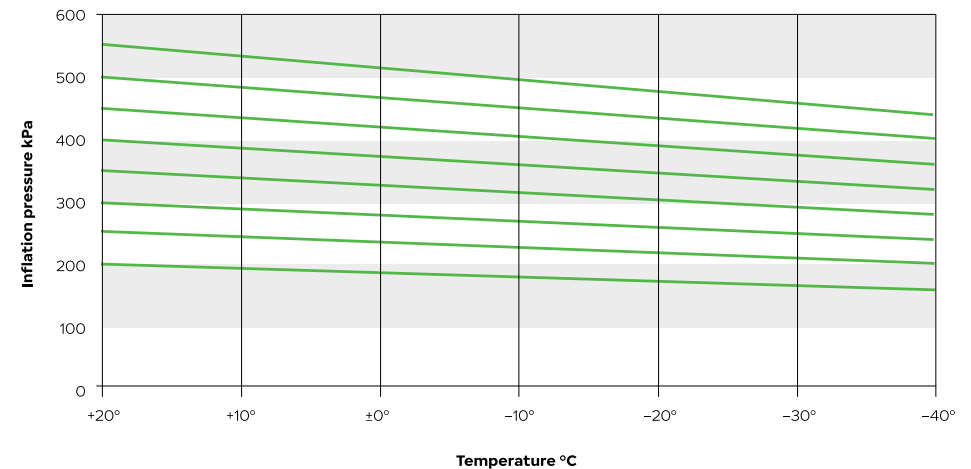

purpose better.

**Nokian Tyres Soil King VF**

# LIQUID AND SALT BALLASTING

- Liquid ballasting is used to increase machine stability
- It is recommended to use professional tire outlets to carry out the filling procedure
- Special equipment and water permeable valves are required
- In liquid and salt ballasting, use tubes to prevent rims from rusting

**Note!** If a filler other than liquid is used (i.e. polyurethane), tire warranty does not apply.

**Note!** Do not use liquids or innertubes in tires fitted with sensors. The sensor warranty does not apply in case of damage caused by liquids or accessories such as innertubes.

## WATER BALLASTING

75 % of the tire volume is filled. Amounts listed in the table below.

## WATER AND SALT BALLASTING

The addition of salt will prevent freezing. 75% of the tire volume is filled with the proportions given in the table below. The salt / water solution is calculated at a temperature of -30 °C / -22°F. Normal commercial salt (CaCl<sub>2</sub>), 77% purity, is used.

Any additional salt will not necessarily dissolve in water.

The remaining tire volume is inflated to the recommended inflation pressure.

**Notice!** Since tire has air only 25% of the original volume, regular inflation pressure checks are highly recommended.

# TRACTOR AND LOADER TIRES FOR WINTER APPLICATION

Tractor and loader tyres are currently excluded from the scope of winter performance testing and certification established and enforced by supranational authorities UN ECE and European Commission.

In order to acquire the 3PMSF (Three-Peak Mountain Snowflake) “Alpine Symbol,” a tyre must be within the scope of UN ECE Regulation 117:

Tyre type: C1 (passenger car tyres), C2, C3 (truck and bus tyres)

- Vehicle type: M, N, or O (car, bus, truck, trailers)
- Tyre speed rating: F (80 km/h) or more
- Rim diameter: More than 10” and below 25”

In the absence of specific regulations, it is up to the manufacturer to choose to verify the winter performance properties of their tractor and loader tyres marketed for winter applications through their own test procedures.

The Nokian Heavy Tyres products developed and tested for high performance in winter applications include

Nokian Tyres TRI2, Nokian Tyres Hakkapeliitta TRI, and Nokian Tyres Hakkapeliitta Loader.

The marking “M+S” has been adopted by Nokian Tyres as an indication of suitability for winter applications based on winter testing.



### Features of Nokian Heavy Tyres products for winter applications

- The materials used in the casing of the tyre withstand and maintain performance in sub-zero temperatures.
- The tread pattern material used in the tyres is developed for high friction on ice and snow, even in sub-zero temperatures.
- The pattern consists of multiple pattern elements with edges to enhance longitudinal and lateral grip for acceleration, braking, and steering on snow. In the case of Nokian Tyres Hakkapeliitta TRI and Hakkapeliitta Loader, the pattern also includes siping up to 80% of the pattern depth.

Winter performance testing for these tyres has been conducted at the Nokian Tyres Winter Testing Center in Ivalo, Finland.

# NON-SKID CHAINS

Nowadays, the general tendency is to work increasingly without chains. This in turn places additional demands on forestry tire selection in order to ensure access to difficult terrain while, at the same time, minimising ground disturbance. In practise, however, there are situations when the use of chains cannot be avoided. In such cases, it is important to pay attention to some basic considerations.

## USE OF CHAINS

Before installing new chains, it is recommended that they be inspected for sharp edges or welding burrs. When installing chains on a tire, it is important to ensure that the chains are sufficiently tight. Chains that are too loose can slip on the tire causing excessive wear.

Checking the functioning of old and worn chains is recommended from time to time as well. It is important to check that no chain rings are broken and that none of these individual rings have turned, so that their calks cut into the tire. The same damage can occur with severely worn and thus overstretched chains.



# TRACKS

Track manufacturers give their recommendations in slightly different ways. The practice, that is becoming increasingly common, is where track manufacturers specify their products according to the tire manufacturer, the tread design and the tire size. The minimum requirement is that the track manufacturer provide the tire size and the tread design for each track type.

When acquiring tracks, it is extremely important

for the user to select the correct track type which is suitable for the tire and that the operating pressure, in particular, meets the recommendations of track manufacturers. When selecting tracks, it is recommended that the user contacts the track manufacturer.

When using tracks the correct pressure level is the maximum permitted inflation pressure for each tire size.

## RECOMMENDED INFLATION PRESSURES WHEN USING TRACKS

| Tire size   | PR | LI / SS         | kPa | psi |
|-------------|----|-----------------|-----|-----|
| 500/60-22.5 | 16 |                 | 430 | 62  |
| 600/50-22.5 | 16 | 151 A8 / 158 A2 | 430 | 62  |
| 700/45-22.5 | 16 |                 | 390 | 57  |
| 710/40-22.5 | 16 | 154 A8 / 161 A2 | 390 | 57  |
| 710/40-24.5 | 20 | 163 A8 / 190 A2 | 550 | 80  |
| 600/55-26.5 | 16 |                 | 460 | 67  |
| 700/45-26.5 | 16 |                 | 460 | 67  |
| 710/45-26.5 | 16 | 161 A8 / 168 A2 | 460 | 67  |
| 600/55-26.5 | 20 | 165 A8 / 172 A2 | 550 | 80  |
| 650/65-26.5 | 20 | 172 A8 / 179 A2 | 550 | 80  |
| 700/50-26.5 | 20 |                 | 550 | 80  |
| 710/45-26.5 | 20 | 168 A8 / 175 A2 | 550 | 80  |
| 750/55-26.5 | 20 | 177 A8 / 184 A2 | 550 | 80  |
| 780/55-26.5 | 20 | 179 A8 / 186 A2 | 550 | 80  |
| 800/40-26.5 | 20 | 170 A8 / 177 A2 | 550 | 80  |
| 650/45R24.5 |    | 161 A8 / 168 A2 | 550 | 80  |
| 600/55R26.5 |    | 165 A8 / 172 A2 | 550 | 80  |
| 710/45R26.5 |    | 168 A8 / 175 A2 | 550 | 80  |
| 800/50R26.5 |    | 180 A8 / 187 A2 | 550 | 80  |

**Notice!** Contact the track manufacturer for the correct track for your tire.



# RIMS

## STANDARDS

Tires are designed for use on rims that meet the industry standards. It is the responsibility of the vehicle manufacturers and vehicle users that rims used comply with these standards.

The right tire and rim combination defined in these standards guarantees a proper mounting and fit of tire on the rim. Standards manuals give the proper rim dimensions and the right rim contours for use on each tire size and service condition.

Rims and wheels may be stamped with maximum load and maximum cold inflation ratings. If these are not identified consult the rim and wheel manufacturer for rim and wheel capacities for the intended service.



Tire and rim standards manuals.

|              |                                                          |
|--------------|----------------------------------------------------------|
| <b>TRA</b>   | The Tire and Rim Association Inc.                        |
| <b>ETRTO</b> | The European Tire and Rim Technical Organisation         |
| <b>JATMA</b> | The Japan Automobile Tire Manufacturers Association Inc. |
| <b>STRO</b>  | The Scandinavian Tire & Rim Organisation                 |

## INFORMATION NEEDED FOR DEFINING A WHEEL

A wheel consists of a rim and a disc. Rim contours are standardised and differ from each other according to the service type. Wheel discs are characterised by the offset position, attachment and centre hole.

To define a wheel for a certain application, the following information is needed by the wheel manufacturer:

### INFORMATION FROM THE TIRE MANUFACTURER:

1. Tire size, loading requirements and service type
2. Nominal width code (inch)
3. Diameter code (inch)
4. Tubeless or tube-type tire

With this tire information the rim contour can be designed.

### INFORMATION FROM THE VEHICLE MANUFACTURER:

5. Offset
6. Disc centre hole
7. Attachment (bolt circle diameter, bolt hole size, bolt hole type)
8. Wheel loading and maximum speed requirements
9. Valve hole placement, type of valve preferred and need for valve protection
10. The wheel colour

With this information a standard or a tailored wheel can be defined.

**Notice!** When in doubt consult rim and wheel manufacturer for confirmation on the strength of the rim/wheel for the intended service.

# RIM MARKINGS

**Disc wheels and demountable rims shall be marked with the following information:**

- a) Rim size designation
- b) Wheel/rim manufacturer (name, symbol or trademark)
- c) date of manufacture
- d) part number or code

**Rings shall be marked with the following information:**

- a) Identification of rim to which the part may be fitted
- b) Identification of manufacturer
- c) Date of manufacture
- d) Flange height designation (on side rings for EM rims)

**Notice!** With recommended rim you get the best operational result from your tire. You may use also permitted rim as an alternative.

**Notice!**  
 - indicates multi-piece rim.  
 x indicates one-piece rim.

| Rim marking     |    |                 | Rim contour |         | Nominal diameter code | Special features                                               |
|-----------------|----|-----------------|-------------|---------|-----------------------|----------------------------------------------------------------|
|                 |    |                 | Width code  | Profile |                       |                                                                |
| 61/2J x 15 H2   | or | 15 x 61/2J H2   | 6 1/2       | J       | 15                    | Asymmetrical drop-centre, double hump (H2). (if S=symmetrical) |
| 225 x 750       |    |                 | 7.5         |         | 22.5                  |                                                                |
| 10.00 V -20     | or | 20 - 10.00 V    | 10          | V       | 20                    |                                                                |
| DW16L x 26      | or | 26 x SW 16L     | 16          | L       | 26                    | Secondary Well (DW)                                            |
| 8.00TG - 24 SDC | or | 24 - 8.00TG SDC | 8.00        | TG      | 24                    | Semi-Drop Centre (SDC)                                         |
| 11.25 - 25/2.0  | or | 25 - 11.25/2.0  | 11.25       |         | 25                    | Flange Height Code ( /2.0)                                     |

# WHEEL STUD HOLES AND COUNTER SINKS

## WHEEL CONNECTION TO THE HUB

The stud/bolt holes in the wheel's center disc together with the center hole define the wheel's connection to the hub. To make sure the wheel is connected centrally, the wheel has two options.

One is to center the wheel via the center hole using a specified tolerance, then typically the bolt/stud holes are straight. This solutions is often used for example in tractors.

The other is to use chamfered bolt/stud holes, which enables the wheel to center itself using the holes geometry. In that case the tolerance of the center hole is slightly larger.

| Bolt Hole Diameters $d_1$ | Countersink Type      |                                                |                               |                                              |
|---------------------------|-----------------------|------------------------------------------------|-------------------------------|----------------------------------------------|
|                           | Spherical Countersink |                                                | Conical countersink           |                                              |
|                           | Sphere Radii - $r$    | Spherical countersink outside diameter - $d_2$ | Countersink angles - $\alpha$ | Conical countersink outside diameter - $d_2$ |
| 18                        | 16                    | 27                                             | 60                            | 22                                           |
| 20                        | 18                    | 29                                             | 90                            | 27                                           |
| 21                        |                       | 32                                             |                               | 29                                           |
| 21.5                      |                       |                                                |                               | 32                                           |
| 22                        |                       |                                                |                               | 35                                           |
| 24                        |                       |                                                |                               |                                              |
| 25.4                      |                       |                                                |                               |                                              |
| 26                        |                       |                                                |                               |                                              |
| 27                        |                       |                                                |                               |                                              |

## COUNTERSINK TYPE

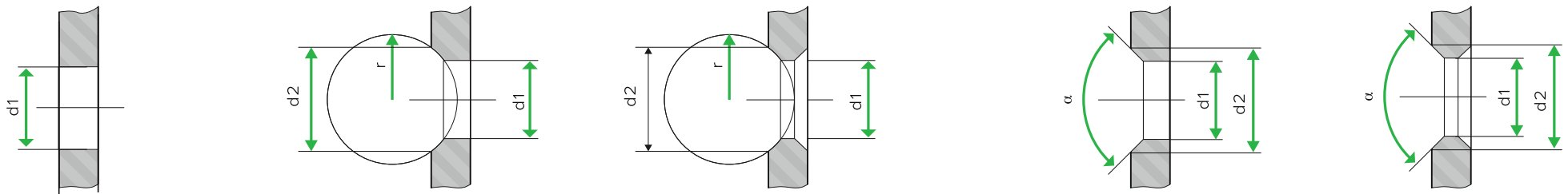

## TYPICAL SPHERICAL COUNTERSINK

| Countersink Designation | Bolt Hole Diameter d1 | d2 | sphere R | Countersink Description | EUWA      | Inside/ Outside/Both |
|-------------------------|-----------------------|----|----------|-------------------------|-----------|----------------------|
| A2                      | 21.5                  | 27 | 16       | AR/D16-27               | B18 ES 32 | Outside              |
| A3                      | 27                    | 32 | 18       | AR/D18-32               | B22 ES 36 | Outside              |
| B2                      | 21.5                  | 27 | 16       | BR/D16-27               | B18 DS 32 | Both                 |
| B3                      | 27                    | 32 | 18       | BR/D-18-32              | B22 DS 36 | Both                 |

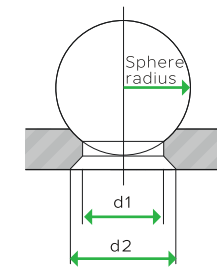
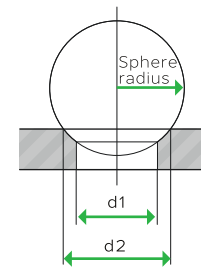

### EUWA 3.15 Stud Hole Designation With A Spherical Countersink

|    |                    |
|----|--------------------|
| B  | Bolt Centric       |
| M  | Hub Centric        |
| 27 | Stud Hole Diameter |
| I  | Inside             |
| E  | Outside            |
| D  | Both               |
| S  | Spherical          |
| 36 | Sphere diameter    |

### Stud hole code Spherical type of stud hole

|    |                                  |
|----|----------------------------------|
| B  | stud centring                    |
| M  | hub centering / double centering |
| 22 | stud diameter                    |
| I  | counter sink inside              |
| E  | external                         |
| D  | double side                      |
| S  | spherical                        |
| 36 | sphere diameter                  |

### Example

|                         |           |
|-------------------------|-----------|
| according to EUWA       |           |
| countersink external    | B22 ES 36 |
| countersink inside      | B22 IS 36 |
| countersink designation | A3        |

### Example

|                         |           |
|-------------------------|-----------|
| according to EUWA       |           |
| countersink double side | B22 DS 36 |
| countersink designation | B3        |

## TYPICAL CONICAL COUNTERSINK

| Countersink Designation | Bolt Hole Diameter d1 | Conical countersink outside diameter - d2 | Countersink angles - $\alpha$ | Countersink Description | EUWA | Inside/ Outside/ Both |
|-------------------------|-----------------------|-------------------------------------------|-------------------------------|-------------------------|------|-----------------------|
| A21                     | 21.5                  | 27                                        | 90                            | A90-27                  | -    | Outside               |
| B21                     | 21.5                  | 27                                        | 90                            | B90-27                  | -    | Both                  |



### EUWA 3.15 Stud Hole Designation With A Conical Countersink

|    |                    |
|----|--------------------|
| B  | Bolt Centric       |
| M  | Hub Centric        |
| 27 | Stud Hole Diameter |
| I  | Inside             |
| E  | Outside            |
| D  | Both               |
| C  | Conical            |
| 60 | Angle              |

### Stud hole code Conical type of stud hole

|    |                                  |
|----|----------------------------------|
| B  | stud centring                    |
| M  | hub centering / double centering |
| 23 | stud diameter                    |
| I  | counter sink inside              |
| E  | external                         |
| D  | double side                      |
| C  | conical                          |
| 80 | angle                            |

### Example

|                         |           |
|-------------------------|-----------|
| according to EUWA       |           |
| countersink external    | B23 EC 80 |
| countersink inside      | B23 IC 80 |
| countersink designation | A17       |

### Example

|                         |           |
|-------------------------|-----------|
| according to EUWA       |           |
| countersink double side | B23 DC 80 |
| countersink designation | B17       |

## CYLINDRICAL (PLAIN STUD HOLES, HUB CENTRIC)

| Bolt Hole Diameter d1 | EUWA |
|-----------------------|------|
| 18                    |      |
| 20                    |      |
| 21                    | M18  |
| 21.5                  |      |
| 22                    |      |
| 24                    | M20  |
| 25.4                  |      |
| 26                    | M22  |
| 27                    |      |

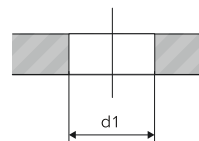

### Example

|                       |     |
|-----------------------|-----|
| according to EUWA     |     |
| cylindrical stud hole | M22 |

# RIM CONTOURS

There are mainly two types of rims used with Nokian Heavy Tyres products. Wide well-base and flat-base contour designs.

## 1. WIDE WELL-BASE (W AND DW)



DW rim



Wide (wide well) and DW (deep well) rim contours

## 2. FLAT BASE RIMS

Flat base rims are generally of divided construction or equipped with lock rings.



Flat base rim

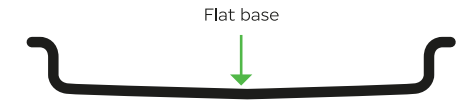

Flat base rim contour

### W OR DW?

DW facilitates better the mounting of high PR (stiffer construction) tires. DW rims also have higher strength compared with W rims, due to more bends in the contour shape.

# WHEEL (DISC INCLUDED) MAIN DIMENSIONS

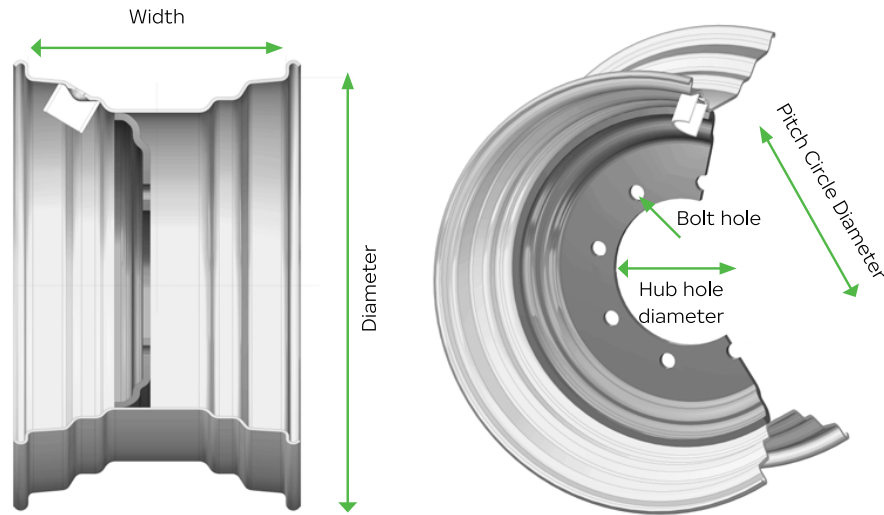

**+ OFFSET DECREASES TRACK WIDTH**

**- OFFSET INCREASES TRACK WIDTH**

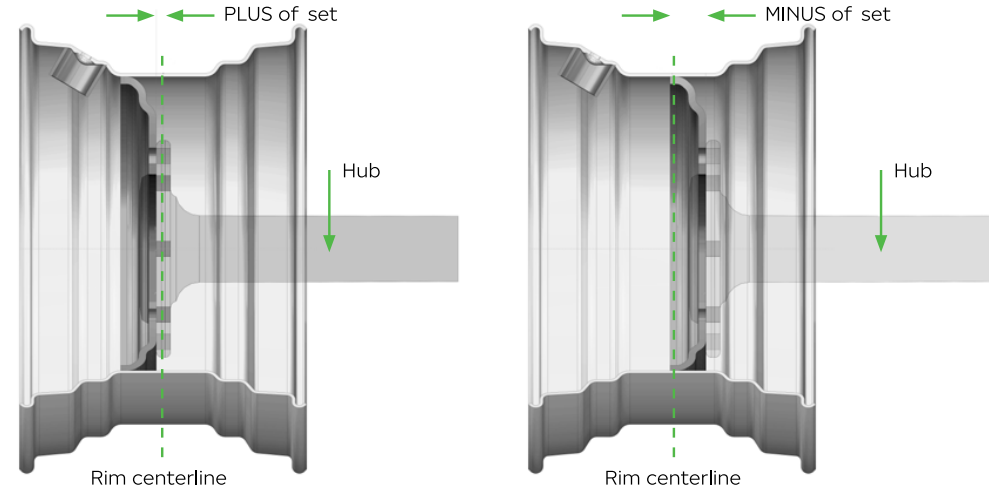

## DISC HOLE DEFINITION (MM)

|     |     |      |    |                             |
|-----|-----|------|----|-----------------------------|
| 281 | 335 | 25,4 | 10 | AR18-32                     |
|     |     |      |    | Countersink                 |
|     |     |      |    | Number of holes             |
|     |     |      |    | Bolt hole diameter          |
|     |     |      |    | Pitch circle diameter (PCD) |
|     |     |      |    | Hub hole diameter           |

Offset is the distance from the rim centerline to the hub mounting surface

+ offset decreases track width

- offset increases track width

# WHEEL PARTS / COMPONENTS

## SINGLE PIECE WHEEL



AG wheel with 2 humps (H2)



## VALVE PROTECTORS

In tough operating conditions, i.e. forestry a R2" thread valve protector is commonly used. A transparent cap enables the use of LED pressure warning device.



R2" valve protector



Transparent cap for R2"



Other types of valve protectors depending on user preferences



# FORESTRY RIMS

## EXAMPLES OF TYPICAL FORESTRY RIM SIZES

AG 22.00 x 22.5 All 15° tapered  
 AG 24.00 x 24.5  
 AG 24.00 x 26.5  
 AG 28.00 x 26.5

DW 20 B x 26 All 5° tapered  
 DW 25 B x 26  
 DW 23 B x 34  
 DW 24 B x 34

**AG** = agricultural rim contour (drop centre rims)

**DW** = deep well rims

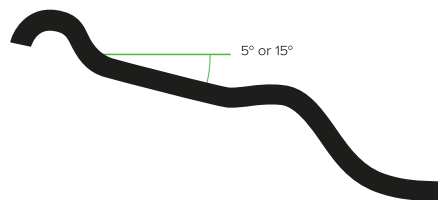

15° tapered in diameter codes xx.5

5° tapered in diameter codes xx

## REINFORCEMENTS

Rims used in professional logging operations are recommended to have contour flange reinforcements. These add load carrying capacity and protect flanges against impacts.



### 1) Rim diameters 24,5" and larger

Recommendation: Flat bar steel on the outside flange. Round steel / tube edge / long rolled flange on the inside flange.

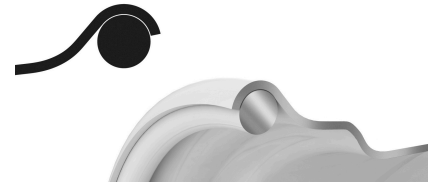

### 2) Rim diameters smaller than 24,5"

Recommended reinforcements depending on loading and operating conditions. Types:

- Round steel
- Tube flange edge
- Long rolled flange edge



Forestry rim with flat bar steel reinforcement

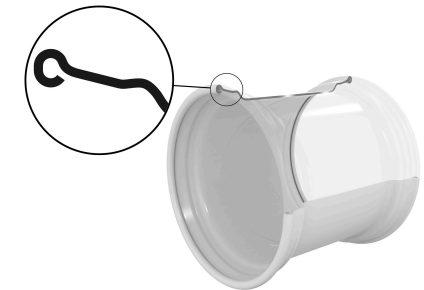

Tube flange edge

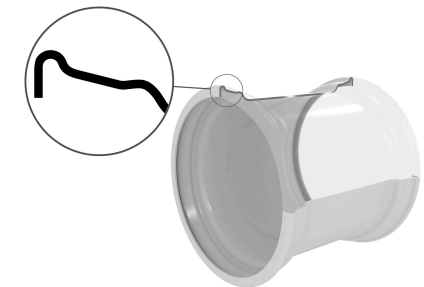

Long rolled flange edge

# KNURLING

Knurling has been designed to prevent tire slippage on rim caused by the inherent traction force on the wheel. To produce the desired effect, knurling must extend beyond the surface of the rim bead seat.



Knurling for tire slippage on rim prevention

## Other methods to prevent tire slippage on rim

- Friction paint on bead area
- Paint removed from bead area

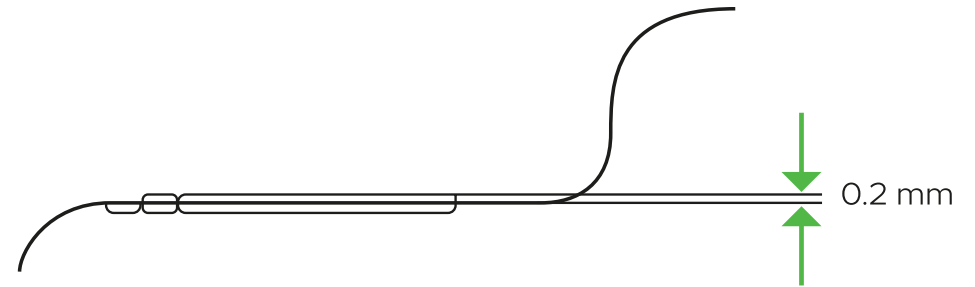

## RECOMMENDATIONS FOR KNURLING USE ON 5° TAPERED RIM CONTOURS

| Rim width       | Rim Diameter | Rim Diameter 24" and larger |
|-----------------|--------------|-----------------------------|
| 13" and smaller | Upon request | Upon request                |
| 14" in smaller  | Upon request | Always                      |

Knurling conditions (ETRTO)

### Notice!

For preventing tire slippage on rim:

1. Proper inflation pressure.
2. Use high quality standards fulfilling rims.

# TUBELESS FORESTRY RIMS

With the introduction of radial forestry tires(Forest Rider), Nokian Heavy Tyres is able to offer tubeless wheels for forestry.

Advantages:

1. No need for tubes and regular tube maintenance
2. No tube valve break-ups from occasional tire wheel spins in severe high torque conditions.
3. If a wheel spin should occur it has no effect on wheel functionality

A tubeless forestry rim has 3 differences compared with a standart similar contour agricultural rim.

1. Rim flange reinforcements
2. Knurling
3. 15° tapered rims with wider hump dimensioning to accomodate stiffer and wider tire bead area.

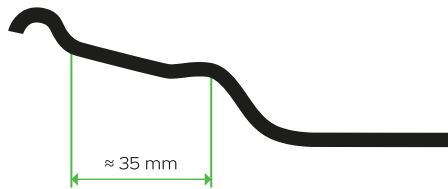

Traditional agricultural rim hump dimensioning

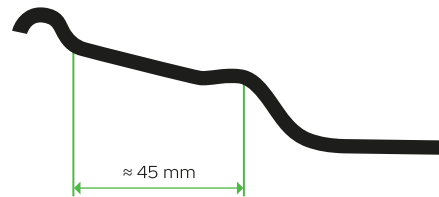

Forestry rim hump dimensioning to accomodate wider tire base

**Notice!**

Rims with wider hump can be used also in agricultural and forestry trailer tires.  
5° tapered rims don't require humps to perform as tubeless (i.e. 34" Forest Rider sizes).

## AGRICULTURAL RIMS

Agricultural rims are TL (tubeless) type. Rim material, rim shape (contour) and material thickness are based on wheel loading requirements.

### EXAMPLES OF AGRICULTURAL RIM SIZES

|                 |                                                                 |
|-----------------|-----------------------------------------------------------------|
| 13.00 x 15.5    | All 15° tapered agricultural rim sizes are equipped with humps. |
| 16.00 x 17      | 5° tapered sizes don't require humps for tubeless use.          |
| AG 13.00 x 22.5 |                                                                 |
| AG 20.00 x 26.5 |                                                                 |
| DW 13 x 24      |                                                                 |
| DW 15 x 24      |                                                                 |

# INDUSTRIAL AND EM MULTI-PIECE WHEELS

## WHEEL PARTS/COMPONENTS



**3-piece rim** / bead set ring, side ring and lock ring the same component



**4-piece rim** / bead set ring and lock ring the same component



**5-piece rim** / all parts separate

### Notice!

Always check that rim load capacity meets or exceeds tire load capacity. As wheel is a highly stressed component it must be inspected periodically.

**Safety and service recommendations for wheels:**  
[www.euwa.org/safety-informations/safety-service](http://www.euwa.org/safety-informations/safety-service)

### Notice!

Wheel, when disc included. Rim, when no disc included.



### MULTI-PIECE RIMS 20" AND 24"

Generally tube-type wheels, requiring a tube and a flap.

Examples of tire sizes:

- 12.00 - 20
- 14.00 - 24

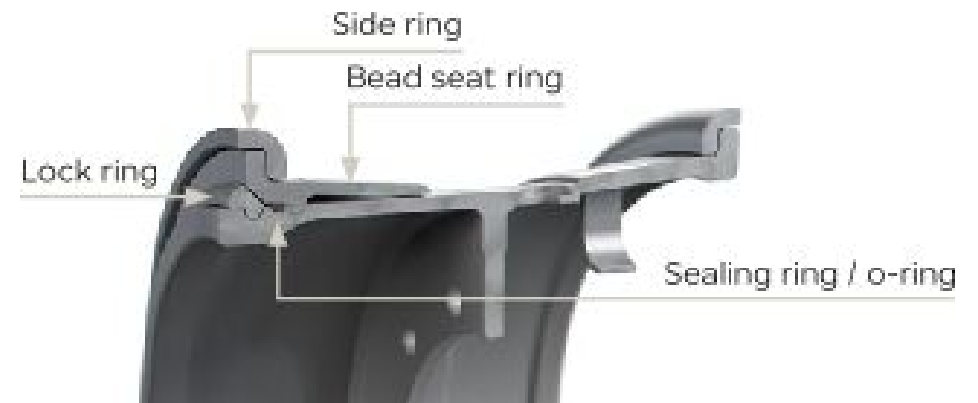

### MULTI-PIECE RIMS 25", 29" AND 33"

Generally tubeless wheel, requiring a sealant ring (o-ring).

Examples of tire sizes:

- 17.5 R 25
- 16.00 R 25
- 18.00 - 25
- 18.00 - 33

## FLAPS

| Product code | Description    | Tire sizes                             |
|--------------|----------------|----------------------------------------|
| T299520      | FLAP 170-20    | 9.00-20, 10.00-20                      |
| T299530      | FLAP 195-20    | 11.00-20, 12.00-20 (rim 8.0)           |
| T299537      | FLAP 255-20    | 12.00-20                               |
| T299538*     | FLAP 260-20    | 14.00-20                               |
| T299531*     | FLAP 260-24/25 | 12.00-24, 14.00-24, 16.00-24, 16.00-25 |
| T299551      | FLAP 350-25    | 17.5-25, 18.00-25                      |
| T299552      | FLAP 500-25    | 23.5-25                                |

\*) Flap valve hole made afterwards depending on required positioning

## O-RINGS

| O-ring code | Nokian Tyres O-ring product code | Rim contours                                                                        |
|-------------|----------------------------------|-------------------------------------------------------------------------------------|
| OR-224      | HTOC 00013                       | 10.00VA                                                                             |
| OR-225      | HTOC 00003                       | 12.00/1.3, 14.00/1.5                                                                |
| OR-325      | HTOC 00004                       | 10.00WA, 11.25/20, 13.00/2.5, 15.00/2.5, 17.00/2.0, 19.50/2.5, 22.00/3.0, 25.00/3.5 |
| OR-329      | HTOC 00008                       | 22.00/3.0, 25.00/3.5                                                                |
| OR-333      | HTOC 00011                       | 13.00/2.5                                                                           |

**OR-2XX: OR: O-ring, 2XX: O-ring diameter: 2: 2/8 inch = 6.35 mm / 3: 3/8 inch = 9.53mm**

## TUBE, FLAP AND O-RING SUITABILITY

| Tire product code | Name                          | Tube product code | Tube description       | Flap product code | Flap description | O-ring* | O-ring description |
|-------------------|-------------------------------|-------------------|------------------------|-------------------|------------------|---------|--------------------|
| T445562           | 9.00-20 16 ARMOR GARD MINE    | T52520            | 9.00 -20 TR 175 TUBE   | T299520           | FLAP 170-20      |         |                    |
| T445451           | 10.00-20 16 ARMOR GARD        | T52620            | 10.00-20 TR 78 TUBE    | T299520           | FLAP 170-20      |         |                    |
| T445649           | 10.00-20 16 ARMOR GARD 2 TT   | T52620            | 10.00-20 TR 78 TUBE    | T299520           | FLAP 170-20      |         |                    |
| T445450           | 11.00-20 16 ARMOR GARD        | T52720            | 11.00-20 TR 179 TUBE   | T299530           | FLAP 195-20      |         |                    |
| T445459           | 12.00-20 20 ARMOR GARD        | T52810            | 12.00-20 V3.02.16 TUBE | T299537           | FLAP 225-20      |         |                    |
| T445449           | 12.00-20 20 ARMOR GARD MINE   | T52810            | 12.00-20 V3.02.16 TUBE | T299537           | FLAP 225-20      |         |                    |
| T445544           | 12.00-20 20 MINE KING L-5S TT | T52810            | 12.00-20 V3.02.16 TUBE | T299537           | FLAP 225-20      |         |                    |
| T445617           | 14.00-20 178A2 MINE KING E-4  | T52920            | 14.00-20 TR 274 TUBE   | T299537           | FLAP 225-20      |         |                    |

| Tire product code | Name                                            | Tube product code | Tube description                          | Flap product code | Flap description | O-ring*   | O-ring description |
|-------------------|-------------------------------------------------|-------------------|-------------------------------------------|-------------------|------------------|-----------|--------------------|
| T488311           | 14.00-24 28 HTS E-3 TL                          | T55767            | 14.00-24 TR 1175 TUBE                     | T299531           | FLAP 260-24/25   | HTOC00004 | OR-325             |
| T445456           | 14.00-24 28 MINE E-3 TL                         | T55767            | 14.00-24 TR 1175 TUBE                     | T299531           | FLAP 260-24/25   | HTOC00004 | OR-325             |
| T445471           | 14.00-24 28 RTG TL                              | T55767            | 14.00-24 TR 1175 TUBE                     | T299531           | FLAP 260-24/25   | HTOC00004 | OR-325             |
| T493551           | 14.00R25 153A8 GRS TL                           | T55767            | 14.00-24 TR 1175 TUBE                     | T299531           | FLAP 260-24/25   | HTOC00013 | OR-224             |
| T445463           | 15.5R25 152B/169A2 LOADER GRIP 2 L-3 TL         | T55810            | 16.00-25 TR J1175 BUT                     | T299551           | FLAP 350-25      | HTOC00003 | OR-225             |
| T488431           | 16.00-25 36 HTS E-4 TL                          | T55810            | 16.00-25 TR J1175 BUT                     |                   |                  | HTOC00004 | OR-325             |
| T445540           | 17.5-25 24 MINE KING L-5S TL                    | T55867            | 17.5-25 TR J1175 TUBE                     | T299551           | FLAP 350-25      | HTOC00003 | OR-225             |
| T445580           | 17.5-25 34 MINE KING L-5S TL                    | T55867            | 17.5-25 TR J1175 TUBE                     | T299551           | FLAP 350-25      | HTOC00003 | OR-225             |
| T493560           | 17.5R25 153A8 GRS TL                            | T55867            | 17.5-25 TR J1175 TUBE                     | T299551           | FLAP 350-25      | HTOC00003 | OR-225             |
| T445255           | 17.5R25 157V/176A2 LOADER GRIP L-3 TL           | T55867            | 17.5-25 TR J1175 TUBE                     | T299551           | FLAP 350-25      | HTOC00003 | OR-225             |
| T445590           | 17.5R25 176A2/153A8 HAKKAPELIITTA LOADER L-2 TL | T55867            | 17.5-25 TR J1175 TUBE                     | T299551           | FLAP 350-25      | HTOC00003 | OR-225             |
| T445545           | 18.00-25 32 MINE KING L-5S TL                   | T55831            | 18.00/ 20.5/ 23.5/ 25/65-25 TR J1175 TUBE | T299551           | FLAP 350-25      | HTOC00004 | OR-325             |
| T445637           | 18.00-25 40 HTS G2 E-4 TL                       | T55831            | 18.00/ 20.5/ 23.5/ 25/65-25 TR J1175 TUBE |                   |                  | HTOC00004 | OR-325             |
| T445638           | 18.00-25 40 HTS G2 L-4S TL                      | T55831            | 18.00/ 20.5/ 23.5/ 25/65-25 TR J1175 TUBE |                   |                  | HTOC00004 | OR-325             |
| T445468           | 18.00-25 40 RTG E-3 TL                          | T55831            | 18.00/ 20.5/ 23.5/ 25/65-25 TR J1175 TUBE |                   |                  | HTOC00004 | OR-325             |
| T445514           | 18.00-33 40 HTS E-4 TL                          |                   |                                           |                   |                  | HTOC00011 | OR-333             |
| T445458           | 18.00-33 40 HTS L-4S TL                         |                   |                                           |                   |                  | HTOC00011 | OR-333             |
| T445171           | 20.5R25 168B/186A2 LOADER GRIP L-3 TL           | T55831            | 18.00/ 20.5/ 23.5/ 25/65-25 TR J1175 TUBE | T299540           | FLAP 430-25      | HTOC00004 | OR-325             |

| Tire product code | Name                                      | Tube product code | Tube description                          | Flap product code | Flap description | O-ring*   | O-ring description |
|-------------------|-------------------------------------------|-------------------|-------------------------------------------|-------------------|------------------|-----------|--------------------|
| T445591           | 20.5R25 186A2 HAKKAPELIITTA LOADER L-2 TL | T55831            | 18.00/ 20.5/ 23.5/ 25/65-25 TR J1175 TUBE | T299540           | FLAP 430-25      | HTOC00004 | OR-325             |
| T445223           | 23.5R25 176B/195A2 LOADER GRIP L-3 TL     | T55831            | 18.00/ 20.5/ 23.5/ 25/65-25 TR J1175 TUBE | T299552           | FLAP 500-25      | HTOC00004 | OR-325             |
| T445592           | 23.5R25 195A2 HAKKAPELIITTA LOADER L-2 TL | T55831            | 18.00/ 20.5/ 23.5/ 25/65-25 TR J1175 TUBE | T299552           | FLAP 500-25      | HTOC00004 | OR-325             |
| T445546           | 26.5-25 36 MINE KING L-5S TL              |                   |                                           |                   |                  | HTOC00004 | OR-325             |
| T445522           | 26.5-25 36 MINE L-3S TL                   |                   |                                           |                   |                  | HTOC00004 | OR-325             |
| T845483           | 26.5R25 NORDMAN MINE E-4 TL               |                   |                                           |                   |                  | HTOC00004 | OR-325             |
| T445547           | 29.5-29 40 MINE KING L-5S TL              |                   |                                           |                   |                  | HTOC00008 | OR-329             |
| T845482           | 29.5R25 NORDMAN MINE E-4 TL               |                   |                                           |                   |                  | HTOC00004 | OR-325             |

\*) O-ring listed is always delivered with the tire

# INSPECTIONS ON RIMS

## ALLOWED WHEEL RADIAL- / LATERAL RUN-OUTS

Tolerances of the rim radial-/lateral run-out in agricultural and industrial use.

| Nominal rim diameter | STRO radial / lateral |           | DIN 7823 radial / lateral |           |
|----------------------|-----------------------|-----------|---------------------------|-----------|
|                      | mm                    | 32 nds in | mm                        | 32 nds in |
| 15" - 20"            | 2.5 / 2.5             | 3.2 / 3.2 | 3.5 / 3.5                 | 4.4 / 4.4 |
| 22" - 28"            | 3.5 / 3.5             | 4.4 / 4.4 | 3.5 / 3.5                 | 4.4 / 4.4 |
| 30" - 38"            | 5.0 / 5.0             | 6.3 / 6.3 | 5.0 / 5.0                 | 6.3 / 6.3 |

## MANDREL GAUGE

- Tolerance of the mandrel circumference is +/- 1.2mm
- Even a small under-swing on circumference accelerates the wearing of the rim and leads to tire rotation on the rim or bead chafing
- Crossing on circumference can cause a tire damage already when fitting the tire on to the rim

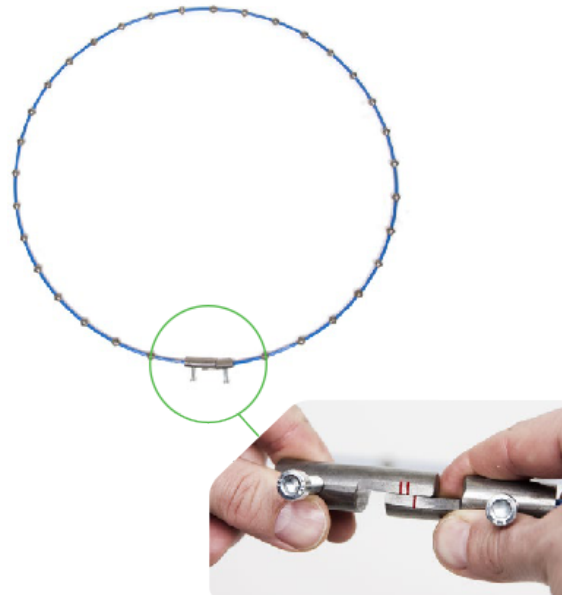

## CONTOUR GAUGE

- If the flange is worn out or bent it does not support the bead of the tire and can cause bead chafing and ruin the tire



# TIRE MOUNTING CLAMPS

Mounting clamp is developed and tested to make mounting easier.



1. Jaw shape is designed to fit with most common reinforced rims. See Suitability table for rims whose compatibility has been tested by Nokian Tyres.
2. Comfortable to handle and doesn't damage the tire
3. Made to last: material thickness 15 mm, screw M20
4. Tommy screws movable pin makes tightening easier

## TIRE MOUNTING CLAMPS BY NOKIAN HEAVY TYRES

|                                |   |                      |                      |
|--------------------------------|---|----------------------|----------------------|
| AG Single Clamp Mounting       | → |                      |                      |
|                                |   | Clamp AG Small       |                      |
| AG Dual Clamp Mounting         | → |                      | +                    |
|                                |   | Clamp AG Big         | Clamp AG Small       |
| DW/TW/DH Single Clamp Mounting | → |                      |                      |
|                                |   | Clamp DW/TW/DH Small |                      |
| DW/TW Clamp Mounting           | → |                      | +                    |
|                                |   | Clamp DW/TW Big      | Clamp DW/TW/DH Small |
| DH Dual Clamp Mounting         | → |                      | +                    |
|                                |   | Clamp DW/TW/DH Small | Clamp DH Big         |

## TECHNICAL SPECIFICATIONS

| Product code | Description                        | Suitable rim profiles | Suitable tires                                                                         | Weight (kg) | Dimensions (mm) | Notes                                                                                                                                                                                                        |
|--------------|------------------------------------|-----------------------|----------------------------------------------------------------------------------------|-------------|-----------------|--------------------------------------------------------------------------------------------------------------------------------------------------------------------------------------------------------------|
| HTTMC00001   | Tyre mounting clamp AG Big         | AG (15°)              | Nokian Forestry and Exavator tires fitted on AG 15° profile rims                       | 5           | 300 x 340 x 40  | Used for AG profile rims in dual clamp mounting as an assistant clamp with smaller HTTMC00002. If rim is with hump design, this clamp fits to WB(Wide Bead) version.                                         |
| HTTMC00002   | Tyre mounting clamp AG Small       | AG (15°)              | Nokian Forestry, Excavator and Agricultural tires fitted on AG 15° profile rims        | 4.3         | 210 x 265 x 40  | Used for AG rims in single clamp mounting and in dual clamp mounting with HTTMC00001.                                                                                                                        |
| HTTMC00003   | Tyre mounting clamp DW/TW Big      | DW / TW (5°)          | Nokian Forestry and Agricultural tires fitted on 5° DW / TW profile rims               | 8.5         | 440 x 400 x 40  | Used for DW/TW profile rims in dual clamp mounting as an assistant clamp with smaller HTTMC00004.                                                                                                            |
| HTTMC00004   | Tyre mounting clamp DW/TW/DH Small | DW / TW / DH (5°)     | Nokian Forestry, Skidder and Agricultural tires fitted on 5° DW / TW / DH profile rims | 5.5         | 385 x 350 x 40  | Used for DW, TW and DH profile rims in single clamp mounting and in dual clamp mounting with HTTMC00003 or HTTMC00005. In DH rims if dual steel plate welded in rim flange, this mounting clamp doesn't fit. |
| HTTMC00005   | Tyre mounting clamp DH Big         | DH (5°)               | Nokian Skidder tires fitted on 5° DW profile rims                                      | 7.9         | 445 x 385 x 40  | Used for DW profile rims in dual clamp mounting as an assistant clamp with smaller HTTMC00004. If dual steel plate welded in rim flange, this mounting clamp doesn't fit.                                    |

**For detailed mounting instruction videos, please see:**

- » **Excavator tire mounting**
- » **Skidder tire mounting**
- » **CTL tire mounting**

# TUBES AND VALVES

## TUBE MOUNTING

With properly done mounting, the risk of premature tube failure can be virtually eliminated. A so called dual inflation and the use of talcum powder will help ensure that no air gets trapped between the tire and the tube upon installation.

Use of improper or excessive lubricants can lead to rim slippage. This will cause the valve to tear off, which can cause damage to the entire tire.

**For detailed mounting instruction videos, please see:**

- » **Excavator tire mounting**
- » **Skidder tire mounting**
- » **CTL tire mounting**

## INSTRUCTIONS ON TUBE REPLACEMENT HOURS AND INFLATION PRESSURE CHECK-UPS

### REPLACEMENT INSTRUCTION

#### Severe working conditions:

Replace with new tubes every 5 000 hours.

#### Less demanding conditions:

Replace with new tubes every 8 000 – 10 000 hours.

This guideline applies when instructed inflation pressures for the given application are used. This guideline applies when inflation pressure check-ups are regular.

### INSTRUCTION ON REGULAR INFLATION PRESSURE CHECK-UPS

- To be part of the normal forestry machine service procedure
- To be done every at least every 500 working hours

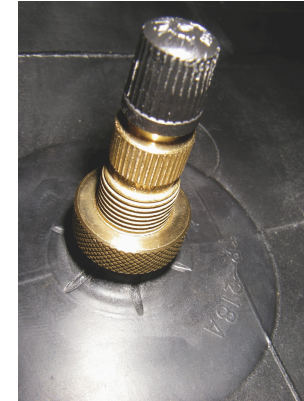

Example of a valve

#### Notice!

Do not use innertubes in tires fitted with sensors. The sensor warranty does not apply in case of damage caused by accessories such as innertubes.

#### Notice!

Use only Nokian Tyres tubes for optimal tube life.

#### Notice!

If pressure instructions and regular inflation pressure check-ups are not applied, tube damages can occur prematurely, even before the minimum 5 000 hour replacement interval.

# TIRE CHOICE AND INFLATION PRESSURES BY APPLICATION

## KOMATSU

| Harvesters | Forwarders      |
|------------|-----------------|
| • 901      | • 825TX         |
| • 901XC    | • 830.3         |
| • 911      | • 840TX         |
| • 931      | • 835           |
| • 931XC    | • 840.4         |
| • 941      | • 845           |
| • 951      | • 855.1 / 855.2 |
| • 951XC    | • 860.4         |
|            | • 865           |
|            | • 875           |
|            | • 890.3         |
|            | • 895           |

## CATERPILLAR

|  | Forwarders |
|--|------------|
|  | • 584      |
|  | • 584 HD   |

## JOHN DEERE

| Harvesters | Forwarders  |
|------------|-------------|
| • 1070E    | • 810E      |
| • 1070G    | • 910G      |
| • 1170E    | • 910/1010G |
| • 1170G    | • 1010E     |
| • 1270E    | • 1010G     |
| • 1270G    | • 1110G     |
| • 1470E    | • 1210G     |
| • 1470G    | • 1510G     |
|            | • 1910E     |
|            | • 1910G     |

## LOGSET

| Harvesters | Forwarders |
|------------|------------|
| • 4H       | • 4F       |
| • 5H       | • 5F       |
| • 6H       | • 6F       |
| • 8H       | • 8F       |
| • 10H      | • 10F      |
|            | • 12F      |

### PONSSE

| Harvesters                                                                                                                                                              | Forwarders                                                                                                                                                                                                                                         |
|-------------------------------------------------------------------------------------------------------------------------------------------------------------------------|----------------------------------------------------------------------------------------------------------------------------------------------------------------------------------------------------------------------------------------------------|
| <ul style="list-style-type: none"> <li>• Beaver</li> <li>• Fox</li> <li>• Scorpion</li> <li>• Scorpion King</li> <li>• Cobra</li> <li>• Ergo</li> <li>• Bear</li> </ul> | <ul style="list-style-type: none"> <li>• Gazelle</li> <li>• Wisent / Dual</li> <li>• Elk</li> <li>• Bison</li> <li>• Buffalo / Dual</li> <li>• Buffalo / Dual / ADS</li> <li>• Buffalo King</li> <li>• Elephant</li> <li>• Elephan King</li> </ul> |

### ROTTNE

| Harvesters                                                                                                                            | Forwarders                                                                                                                                             |
|---------------------------------------------------------------------------------------------------------------------------------------|--------------------------------------------------------------------------------------------------------------------------------------------------------|
| <ul style="list-style-type: none"> <li>• H8</li> <li>• H11</li> <li>• H11c</li> <li>• H14c</li> <li>• H20b</li> <li>• H21d</li> </ul> | <ul style="list-style-type: none"> <li>• F10b</li> <li>• F10d</li> <li>• F11d</li> <li>• F13c</li> <li>• F15c</li> <li>• F18</li> <li>• F20</li> </ul> |







### TIGERCAT







| Harvesters                                                               | Forwarders                                                                                  |
|--------------------------------------------------------------------------|---------------------------------------------------------------------------------------------|
| <ul style="list-style-type: none"> <li>• 1165</li> <li>• 1185</li> </ul> | <ul style="list-style-type: none"> <li>• 1055C</li> <li>• 1075C</li> <li>• 1085C</li> </ul> |







### ECOLOG

| Harvesters                                                                                                                                      | Forwarders                                                                                                                                 |
|-------------------------------------------------------------------------------------------------------------------------------------------------|--------------------------------------------------------------------------------------------------------------------------------------------|
| <ul style="list-style-type: none"> <li>• 1058H5</li> <li>• 550F</li> <li>• 550 T-PRO</li> <li>• 560F</li> <li>• 590F</li> <li>• 688F</li> </ul> | <ul style="list-style-type: none"> <li>• 750F</li> <li>• 1050F</li> <li>• 1250F</li> <li>• 574F</li> <li>• 584F</li> <li>• 594F</li> </ul> |

## KOMATSU HARVESTERS

| Machine         | Tire size / PR | Tread pattern                                                                        |                                                                                         |                                                                                          |                                                                                                    |                                                                                           |                                                                                         |                                                                                                         | Inflation pressure |     |      |     |                                   |  |
|-----------------|----------------|--------------------------------------------------------------------------------------|-----------------------------------------------------------------------------------------|------------------------------------------------------------------------------------------|----------------------------------------------------------------------------------------------------|-------------------------------------------------------------------------------------------|-----------------------------------------------------------------------------------------|---------------------------------------------------------------------------------------------------------|--------------------|-----|------|-----|-----------------------------------|--|
|                 |                |  F2 |  TRS 2 |  TRS 2+ |  F<br>*Nordman F |  Rider |  ELS |  TRS<br>*Nordman TRS | Front              |     | Rear |     | Max. inflation and track pressure |  |
|                 |                |                                                                                      |                                                                                         |                                                                                          |                                                                                                    |                                                                                           |                                                                                         | kPa                                                                                                     | psi                | kPa | psi  | kPa | psi                               |  |
| <b>901</b>      | 600/65-34/20   |                                                                                      |                                                                                         |                                                                                          |                                                                                                    |                                                                                           |                                                                                         |                                                                                                         |                    |     |      |     |                                   |  |
| <b>4 wheels</b> | 600/65-34/24   |                                                                                      |                                                                                         | Front, Rear                                                                              |                                                                                                    |                                                                                           |                                                                                         |                                                                                                         |                    |     |      |     |                                   |  |
|                 | 600/65R34      |                                                                                      |                                                                                         |                                                                                          |                                                                                                    | Front, Rear                                                                               |                                                                                         |                                                                                                         |                    |     |      |     |                                   |  |
|                 | 700/55-34/20   |                                                                                      |                                                                                         |                                                                                          |                                                                                                    |                                                                                           |                                                                                         |                                                                                                         |                    |     |      |     |                                   |  |
|                 | 710/55-34/24   |                                                                                      |                                                                                         | Front, Rear                                                                              |                                                                                                    |                                                                                           |                                                                                         |                                                                                                         |                    |     |      |     |                                   |  |
|                 | 710/55R34      |                                                                                      |                                                                                         |                                                                                          |                                                                                                    | Front, Rear                                                                               |                                                                                         |                                                                                                         |                    |     |      |     |                                   |  |
| <b>901</b>      | 600/50-24.5/20 |                                                                                      | Front                                                                                   |                                                                                          |                                                                                                    |                                                                                           |                                                                                         | 550                                                                                                     | 80                 |     |      | 550 | 80                                |  |

| Machine         | Tire size / PR | Tread pattern                                                                     |                                                                                   |                                                                                   |                                                                                   |                                                                                     |                                                                                     |                                                                                     | Inflation pressure |     |      |     |                                   |     |
|-----------------|----------------|-----------------------------------------------------------------------------------|-----------------------------------------------------------------------------------|-----------------------------------------------------------------------------------|-----------------------------------------------------------------------------------|-------------------------------------------------------------------------------------|-------------------------------------------------------------------------------------|-------------------------------------------------------------------------------------|--------------------|-----|------|-----|-----------------------------------|-----|
|                 |                |  |  |  |  |  |  |  | Front              |     | Rear |     | Max. inflation and track pressure |     |
|                 |                | F2                                                                                | TRS 2                                                                             | TRS 2+                                                                            | F<br>*Nordman F                                                                   | Rider                                                                               | ELS                                                                                 | TRS<br>*Nordman TRS                                                                 | kPa                | psi | kPa  | psi | kPa                               | psi |
| <b>6 wheels</b> | 650/45R24.5    |                                                                                   |                                                                                   |                                                                                   |                                                                                   | Front                                                                               |                                                                                     |                                                                                     | 550                | 80  |      |     | 550                               | 80  |
|                 | 710/40-24.5/20 | Front                                                                             | Front                                                                             |                                                                                   | Front                                                                             |                                                                                     |                                                                                     | 550                                                                                 | 80                 |     |      | 550 | 80                                |     |
|                 | 600/65-34/20   |                                                                                   |                                                                                   |                                                                                   |                                                                                   |                                                                                     | *Rear                                                                               |                                                                                     |                    | 320 | 46   | 360 | 52                                |     |
|                 | 600/65-34/24   |                                                                                   |                                                                                   | Rear                                                                              |                                                                                   |                                                                                     |                                                                                     |                                                                                     |                    | 320 | 46   | 400 | 58                                |     |
|                 | 600/65R34      |                                                                                   |                                                                                   |                                                                                   |                                                                                   | Rear                                                                                |                                                                                     |                                                                                     |                    | 320 | 46   | 400 | 58                                |     |
|                 | 700/55-34/20   |                                                                                   |                                                                                   |                                                                                   |                                                                                   |                                                                                     | *Rear                                                                               |                                                                                     |                    | 320 | 46   | 360 | 52                                |     |
|                 | 710/55-34/24   |                                                                                   |                                                                                   | Rear                                                                              |                                                                                   |                                                                                     |                                                                                     |                                                                                     |                    | 320 | 46   | 400 | 58                                |     |
|                 | 710/55R34      |                                                                                   |                                                                                   |                                                                                   |                                                                                   | Rear                                                                                |                                                                                     |                                                                                     |                    | 320 | 46   | 400 | 58                                |     |
| <b>901XC</b>    | 600/50-24.5/20 |                                                                                   | Front, Rear                                                                       |                                                                                   |                                                                                   |                                                                                     |                                                                                     | 500                                                                                 | 73                 | 320 | 46   | 550 | 80                                |     |
| <b>8 wheels</b> | 710/40-24.5/20 | Front, Rear                                                                       | Front, Rear                                                                       |                                                                                   | Front, Rear                                                                       |                                                                                     |                                                                                     | 500                                                                                 | 73                 | 320 | 46   | 550 | 80                                |     |
|                 | 800/40-24.5/20 | Front, Rear                                                                       | Front, Rear                                                                       |                                                                                   |                                                                                   |                                                                                     |                                                                                     | 500                                                                                 | 73                 | 320 | 46   | 550 | 80                                |     |
| <b>911</b>      | 600/65-34/20   |                                                                                   |                                                                                   |                                                                                   |                                                                                   |                                                                                     | *Front, Rear                                                                        | 320                                                                                 | 46                 | 320 | 46   | 360 | 52                                |     |
| <b>4 wheels</b> | 600/65-34/24   |                                                                                   |                                                                                   | Front, Rear                                                                       |                                                                                   |                                                                                     |                                                                                     | 320                                                                                 | 46                 | 320 | 46   | 400 | 58                                |     |
|                 | 600/65R34      |                                                                                   |                                                                                   |                                                                                   |                                                                                   | Front, Rear                                                                         |                                                                                     | 320                                                                                 | 46                 | 320 | 46   | 400 | 58                                |     |
|                 | 700/55-34/20   |                                                                                   |                                                                                   |                                                                                   |                                                                                   |                                                                                     | *Front, Rear                                                                        | 320                                                                                 | 46                 | 320 | 46   | 360 | 52                                |     |
|                 | 710/55-34/24   |                                                                                   |                                                                                   | Front, Rear                                                                       |                                                                                   |                                                                                     |                                                                                     | 320                                                                                 | 46                 | 320 | 46   | 400 | 58                                |     |
|                 | 710/55R34      |                                                                                   |                                                                                   |                                                                                   |                                                                                   | Front, Rear                                                                         |                                                                                     | 320                                                                                 | 46                 | 320 | 46   | 400 | 58                                |     |
| <b>911</b>      | 600/55R26.5    |                                                                                   |                                                                                   |                                                                                   |                                                                                   | Front                                                                               |                                                                                     | 460                                                                                 | 67                 |     |      | 550 | 80                                |     |
| <b>6 wheels</b> | 600/55-26.5/20 | Front                                                                             | Front                                                                             |                                                                                   | Front, *Front                                                                     |                                                                                     | *Front                                                                              | 460                                                                                 | 67                 |     |      | 550 | 80                                |     |
|                 | 710/45R26.5    |                                                                                   |                                                                                   |                                                                                   |                                                                                   | Front                                                                               |                                                                                     | 460                                                                                 | 67                 |     |      | 550 | 80                                |     |







| Machine         | Tire size / PR | Tread pattern                                                                     |                                                                                   |                                                                                   |                                                                                   |                                                                                     |                                                                                     |                                                                                     | Inflation pressure |     |      |     |                                   |     |
|-----------------|----------------|-----------------------------------------------------------------------------------|-----------------------------------------------------------------------------------|-----------------------------------------------------------------------------------|-----------------------------------------------------------------------------------|-------------------------------------------------------------------------------------|-------------------------------------------------------------------------------------|-------------------------------------------------------------------------------------|--------------------|-----|------|-----|-----------------------------------|-----|
|                 |                |  |  |  |  |  |  |  | Front              |     | Rear |     | Max. inflation and track pressure |     |
|                 |                | F2                                                                                | TRS 2                                                                             | TRS 2+                                                                            | F<br>*Nordman F                                                                   | Rider                                                                               | ELS                                                                                 | TRS<br>*Nordman TRS                                                                 | kPa                | psi | kPa  | psi | kPa                               | psi |
|                 | 710/45-26.5/16 |                                                                                   |                                                                                   |                                                                                   | Front                                                                             |                                                                                     |                                                                                     |                                                                                     | 460                | 67  |      |     | 460                               | 67  |
|                 | 710/45-26.5/20 | Front                                                                             | Front                                                                             |                                                                                   | Front, *Front                                                                     |                                                                                     |                                                                                     | *Front                                                                              | 460                | 67  |      |     | 550                               | 80  |
|                 | 710/45-26.5/24 | Front                                                                             |                                                                                   |                                                                                   | Front                                                                             |                                                                                     |                                                                                     |                                                                                     | 460                | 67  |      |     | 600                               | 87  |
|                 | 800/40-26.5/20 | Front                                                                             | Front                                                                             |                                                                                   | Front                                                                             |                                                                                     |                                                                                     |                                                                                     | 460                | 67  |      |     | 550                               | 80  |
|                 | 600/65-34/20   |                                                                                   |                                                                                   |                                                                                   |                                                                                   |                                                                                     |                                                                                     | *Rear                                                                               |                    |     | 320  | 46  | 360                               | 52  |
|                 | 600/65-34/24   |                                                                                   |                                                                                   | Rear                                                                              |                                                                                   |                                                                                     |                                                                                     |                                                                                     |                    |     | 320  | 46  | 400                               | 58  |
|                 | 600/65R34      |                                                                                   |                                                                                   |                                                                                   |                                                                                   | Rear                                                                                |                                                                                     |                                                                                     |                    |     | 320  | 46  | 400                               | 68  |
|                 | 700/55-34/20   |                                                                                   |                                                                                   |                                                                                   |                                                                                   |                                                                                     |                                                                                     | *Rear                                                                               |                    |     | 320  | 46  | 360                               | 52  |
|                 | 710/55-34/24   |                                                                                   |                                                                                   | Rear                                                                              |                                                                                   |                                                                                     |                                                                                     |                                                                                     |                    |     | 320  | 46  | 400                               | 58  |
|                 | 710/55R34      |                                                                                   |                                                                                   |                                                                                   |                                                                                   | Rear                                                                                |                                                                                     |                                                                                     |                    |     | 320  | 46  | 400                               | 58  |
| <b>931</b>      | 600/55R26.5    |                                                                                   |                                                                                   |                                                                                   |                                                                                   | Front                                                                               |                                                                                     |                                                                                     | 500                | 73  |      |     | 550                               | 80  |
| <b>6 wheels</b> | 600/55-26.5/20 | Front                                                                             | Front                                                                             |                                                                                   | Front, *Front                                                                     |                                                                                     |                                                                                     | *Front                                                                              | 500                | 73  |      |     | 550                               | 80  |
|                 | 710/45R26.5    |                                                                                   |                                                                                   |                                                                                   |                                                                                   | Front                                                                               |                                                                                     |                                                                                     | 500                | 73  |      |     | 550                               | 80  |
|                 | 710/45-26.5/20 | Front                                                                             | Front                                                                             |                                                                                   | Front, *Front                                                                     |                                                                                     |                                                                                     | *Front                                                                              | 500                | 73  |      |     | 550                               | 80  |
|                 | 710/45-26.5/24 | Front                                                                             |                                                                                   |                                                                                   | Front                                                                             |                                                                                     |                                                                                     |                                                                                     | 500                | 73  |      |     | 600                               | 87  |
|                 | 800/40-26.5/20 | Front                                                                             | Front                                                                             |                                                                                   | Front                                                                             |                                                                                     |                                                                                     |                                                                                     | 500                | 73  |      |     | 550                               | 80  |
|                 | 600/65-34/20   |                                                                                   |                                                                                   |                                                                                   |                                                                                   |                                                                                     |                                                                                     | *Rear                                                                               |                    |     | 320  | 46  | 360                               | 52  |
|                 | 600/65-34/24   |                                                                                   |                                                                                   | Rear                                                                              |                                                                                   |                                                                                     |                                                                                     |                                                                                     |                    |     | 320  | 46  | 400                               | 58  |
|                 | 600/65R34      |                                                                                   |                                                                                   |                                                                                   |                                                                                   | Rear                                                                                |                                                                                     |                                                                                     |                    |     | 320  | 46  | 400                               | 58  |
|                 | 700/55-34/20   |                                                                                   |                                                                                   |                                                                                   |                                                                                   |                                                                                     |                                                                                     | *Rear                                                                               |                    |     | 320  | 46  | 360                               | 52  |







| Machine         | Tire size / PR | Tread pattern                                                                     |                                                                                   |                                                                                   |                                                                                   |                                                                                     |                                                                                     |                                                                                     | Inflation pressure |     |      |     |                                   |     |
|-----------------|----------------|-----------------------------------------------------------------------------------|-----------------------------------------------------------------------------------|-----------------------------------------------------------------------------------|-----------------------------------------------------------------------------------|-------------------------------------------------------------------------------------|-------------------------------------------------------------------------------------|-------------------------------------------------------------------------------------|--------------------|-----|------|-----|-----------------------------------|-----|
|                 |                |  |  |  |  |  |  |  | Front              |     | Rear |     | Max. inflation and track pressure |     |
|                 |                | F2                                                                                | TRS 2                                                                             | TRS 2+                                                                            | F<br>*Nordman F                                                                   | Rider                                                                               | ELS                                                                                 | TRS<br>*Nordman TRS                                                                 | kPa                | psi | kPa  | psi | kPa                               | psi |
|                 | 710/55-34/24   |                                                                                   |                                                                                   | Rear                                                                              |                                                                                   |                                                                                     |                                                                                     |                                                                                     |                    |     | 320  | 46  | 400                               | 58  |
|                 | 710/55R34      |                                                                                   |                                                                                   |                                                                                   |                                                                                   | Rear                                                                                |                                                                                     |                                                                                     |                    |     | 320  | 46  | 400                               | 58  |
| <b>931XC</b>    | 600/55-26.5/20 | Front, Rear                                                                       | Front, Rear                                                                       |                                                                                   | Front, Rear<br>*Front, *Rear                                                      |                                                                                     |                                                                                     | *Front, *Rear                                                                       | 500                | 73  | 400  | 58  | 550                               | 80  |
| <b>8 wheels</b> | 710/45-26.5/20 | Front, Rear                                                                       | Front, Rear                                                                       |                                                                                   | Front, Rear<br>*Front, *Rear                                                      |                                                                                     |                                                                                     | *Front, *Rear                                                                       | 500                | 73  | 400  | 58  | 550                               | 80  |
|                 | 710/45-26.5/24 | Front, Rear                                                                       | Front, Rear                                                                       |                                                                                   | Front, Rear                                                                       |                                                                                     |                                                                                     |                                                                                     | 500                | 73  | 400  | 58  | 600                               | 87  |
|                 | 800/40-26.5/20 | Front, Rear                                                                       | Front, Rear                                                                       |                                                                                   | Front, Rear                                                                       |                                                                                     |                                                                                     |                                                                                     | 500                | 73  | 400  | 58  | 550                               | 80  |
| <b>941</b>      | 650/65-26.5/20 |                                                                                   |                                                                                   |                                                                                   |                                                                                   |                                                                                     | Front                                                                               | Front                                                                               | 500                | 73  |      |     | 550                               | 80  |
| <b>6 wheels</b> | 750/55-26.5/20 |                                                                                   |                                                                                   |                                                                                   | Front, *Front                                                                     |                                                                                     |                                                                                     | Front, *Front                                                                       | 500                | 73  |      |     | 550                               | 80  |
|                 | 750/55-26.5/24 | Front                                                                             | Front                                                                             |                                                                                   |                                                                                   |                                                                                     |                                                                                     |                                                                                     | 500                | 73  |      |     | 600                               | 87  |
|                 | 780/55-26.5/20 |                                                                                   |                                                                                   |                                                                                   | Front                                                                             |                                                                                     |                                                                                     |                                                                                     | 500                | 73  |      |     | 550                               | 80  |
|                 | 800/50R26.5    |                                                                                   |                                                                                   |                                                                                   |                                                                                   | Front                                                                               |                                                                                     |                                                                                     | 500                | 73  |      |     | 550                               | 80  |
|                 | 700/70-34/16   |                                                                                   |                                                                                   |                                                                                   |                                                                                   |                                                                                     |                                                                                     | Rear                                                                                |                    |     | 260  | 38  | 260                               | 38  |
|                 | 700/70-34/20   |                                                                                   |                                                                                   |                                                                                   |                                                                                   |                                                                                     |                                                                                     | *Rear                                                                               |                    |     | 320  | 46  | 360                               | 52  |
|                 | 710/70-34/24   |                                                                                   |                                                                                   | Rear                                                                              |                                                                                   |                                                                                     |                                                                                     |                                                                                     |                    |     | 320  | 46  | 400                               | 58  |
|                 | 710/70R34      |                                                                                   |                                                                                   |                                                                                   |                                                                                   | Rear                                                                                |                                                                                     |                                                                                     |                    |     | 320  | 46  | 400                               | 58  |
| <b>951XC</b>    | 710/45-26.5/24 | Front, Rear                                                                       | Front, Rear                                                                       |                                                                                   |                                                                                   |                                                                                     |                                                                                     |                                                                                     | 500                | 73  | 400  | 58  | 600                               | 87  |
| <b>8 wheels</b> | 800/40-26.5/20 | Front, Rear                                                                       | Front, Rear                                                                       |                                                                                   |                                                                                   |                                                                                     |                                                                                     |                                                                                     | 500                | 73  | 400  | 58  | 550                               | 80  |
| <b>951</b>      | 710/55-28.5/24 | Front                                                                             | Front                                                                             |                                                                                   |                                                                                   |                                                                                     |                                                                                     |                                                                                     | 500                | 73  |      |     | 600                               | 87  |
| <b>6 wheels</b> | 780/50-28.5/24 | Front                                                                             | Front                                                                             |                                                                                   |                                                                                   |                                                                                     |                                                                                     |                                                                                     | 500                | 73  |      |     | 600                               | 87  |

| Machine | Tire size / PR | Tread pattern                                                                     |                                                                                   |                                                                                   |                                                                                   |                                                                                     |                                                                                     |                                                                                     | Inflation pressure |     |      |     |                                   |     |
|---------|----------------|-----------------------------------------------------------------------------------|-----------------------------------------------------------------------------------|-----------------------------------------------------------------------------------|-----------------------------------------------------------------------------------|-------------------------------------------------------------------------------------|-------------------------------------------------------------------------------------|-------------------------------------------------------------------------------------|--------------------|-----|------|-----|-----------------------------------|-----|
|         |                |  |  |  |  |  |  |  | Front              |     | Rear |     | Max. inflation and track pressure |     |
|         |                | F2                                                                                | TRS 2                                                                             | TRS 2+                                                                            | F *Nordman F                                                                      | Rider                                                                               | ELS                                                                                 | TRS *Nordman TRS                                                                    | kPa                | psi | kPa  | psi | kPa                               | psi |
|         | 710/70-34/24   |                                                                                   |                                                                                   | Rear                                                                              |                                                                                   |                                                                                     |                                                                                     |                                                                                     |                    |     | 320  | 46  | 400                               | 58  |
|         | 710/70R34      |                                                                                   |                                                                                   |                                                                                   |                                                                                   | Rear                                                                                |                                                                                     |                                                                                     |                    |     | 320  | 46  | 400                               | 58  |

## KOMATSU FORWARDERS







| Machine         | Tire size / PR | Tread pattern                                                                     |                                                                                   |                                                                                   |                                                                                    |                                                                                     |                                                                                     |                                                                                     | Inflation pressure |     |      |     |                                   |     |
|-----------------|----------------|-----------------------------------------------------------------------------------|-----------------------------------------------------------------------------------|-----------------------------------------------------------------------------------|------------------------------------------------------------------------------------|-------------------------------------------------------------------------------------|-------------------------------------------------------------------------------------|-------------------------------------------------------------------------------------|--------------------|-----|------|-----|-----------------------------------|-----|
|                 |                |  |  |  |  |  |  |  | Front              |     | Rear |     | Max. inflation and track pressure |     |
|                 |                | F2                                                                                | TRS 2                                                                             | TRS 2+                                                                            | F *Nordman F                                                                       | Rider                                                                               | ELS                                                                                 | TRS *Nordman TRS                                                                    | kPa                | psi | kPa  | psi | kPa                               | psi |
| <b>825TX</b>    | 600/50-22.5/20 | Front, Rear                                                                       | Front, Rear                                                                       |                                                                                   |                                                                                    |                                                                                     | Front, Rear                                                                         | Front, Rear                                                                         | 350                | 51  | 500  | 73  | 550                               | 80  |
| <b>8 wheels</b> | 710/40-22.5/20 | Front, Rear                                                                       | Front, Rear                                                                       |                                                                                   | Front, Rear                                                                        |                                                                                     | Front, Rear                                                                         | Front, Rear                                                                         | 350                | 51  | 500  | 73  | 550                               | 80  |
| <b>830.3</b>    | 600/50-22.5/16 |                                                                                   |                                                                                   |                                                                                   |                                                                                    |                                                                                     | Front, Rear                                                                         | Front, Rear                                                                         | 350                | 51  | 430  | 62  | 430                               | 62  |
| <b>8 wheels</b> | 600/50-22.5/20 |                                                                                   |                                                                                   |                                                                                   |                                                                                    |                                                                                     | Front, Rear                                                                         | Front, Rear                                                                         | 350                | 51  | 500  | 73  | 550                               | 80  |
|                 | 710/40-22.5/16 |                                                                                   |                                                                                   |                                                                                   | Front, Rear                                                                        |                                                                                     | Front, Rear                                                                         | Front, Rear                                                                         | 350                | 51  | 400  | 58  | 400                               | 58  |
| <b>840TX</b>    | 600/50R24.5    |                                                                                   |                                                                                   |                                                                                   |                                                                                    | Front, Rear                                                                         |                                                                                     |                                                                                     | 400                | 58  | 550  | 80  | 550                               | 80  |
| <b>8 wheels</b> | 650/45R24.5    |                                                                                   |                                                                                   |                                                                                   |                                                                                    | Front, Rear                                                                         |                                                                                     |                                                                                     | 400                | 58  | 550  | 80  | 550                               | 80  |
|                 | 710/40-24.5/20 | Front, Rear                                                                       | Front, Rear                                                                       |                                                                                   | Front, Rear                                                                        |                                                                                     |                                                                                     |                                                                                     | 350                | 51  | 550  | 80  | 550                               | 80  |
| <b>835</b>      | 600/50-24.5/20 |                                                                                   | Front, Rear                                                                       |                                                                                   |                                                                                    |                                                                                     |                                                                                     |                                                                                     | 400                | 58  | 550  | 80  | 550                               | 80  |
| <b>8 wheels</b> | 650/45R24.5    |                                                                                   |                                                                                   |                                                                                   |                                                                                    | Front, Rear                                                                         |                                                                                     |                                                                                     | 400                | 58  | 550  | 80  | 550                               | 80  |
|                 | 710/40-24.5/20 | Front, Rear                                                                       | Front, Rear                                                                       |                                                                                   | Front, Rear                                                                        |                                                                                     |                                                                                     |                                                                                     | 350                | 51  | 550  | 80  | 550                               | 80  |

| Machine         | Tire size / PR | Tread pattern                                                                     |                                                                                   |                                                                                   |                                                                                    |                                                                                     |                                                                                     |                                                                                     | Inflation pressure |     |      |     |                                   |     |
|-----------------|----------------|-----------------------------------------------------------------------------------|-----------------------------------------------------------------------------------|-----------------------------------------------------------------------------------|------------------------------------------------------------------------------------|-------------------------------------------------------------------------------------|-------------------------------------------------------------------------------------|-------------------------------------------------------------------------------------|--------------------|-----|------|-----|-----------------------------------|-----|
|                 |                |  |  |  |  |  |  |  | Front              |     | Rear |     | Max. inflation and track pressure |     |
|                 |                | F2                                                                                | TRS 2                                                                             | TRS 2+                                                                            | F<br>*Nordman F                                                                    | Rider                                                                               | ELS                                                                                 | TRS<br>*Nordman TRS                                                                 | kPa                | psi | kPa  | psi | kPa                               | psi |
|                 | 800/40-24.5/20 | Front, Rear                                                                       | Front, Rear                                                                       |                                                                                   |                                                                                    |                                                                                     |                                                                                     |                                                                                     | 350                | 51  | 550  | 80  | 550                               | 80  |
| <b>840.4</b>    | 600/55-26.5/20 | Front, Rear                                                                       | Front, Rear                                                                       |                                                                                   | Front, Rear,<br>*Front, Rear                                                       |                                                                                     |                                                                                     | *Front, Rear                                                                        | 350                | 51  | 550  | 80  | 550                               | 80  |
| <b>8 wheels</b> | 600/55R26.5    |                                                                                   |                                                                                   |                                                                                   |                                                                                    | Front, Rear                                                                         |                                                                                     |                                                                                     | 350                | 51  | 550  | 80  | 550                               | 80  |
|                 | 710/45R26.5    |                                                                                   |                                                                                   |                                                                                   |                                                                                    | Front, Rear                                                                         |                                                                                     |                                                                                     | 350                | 51  | 500  | 73  | 550                               | 80  |
|                 | 710/45-26.5/20 | Front, Rear                                                                       | Front, Rear                                                                       |                                                                                   | Front, Rear,<br>*Front, Rear                                                       |                                                                                     |                                                                                     | *Front, Rear                                                                        | 350                | 51  | 500  | 73  | 550                               | 80  |
|                 | 710/45-26.5/24 | Front, Rear                                                                       |                                                                                   |                                                                                   | Front, Rear                                                                        |                                                                                     |                                                                                     |                                                                                     | 350                | 51  | 500  | 73  | 600                               | 87  |
|                 | 800/40-26.5/20 | Front, Rear                                                                       | Front, Rear                                                                       |                                                                                   | Front, Rear                                                                        |                                                                                     |                                                                                     |                                                                                     | 350                | 51  | 500  | 73  | 550                               | 80  |
| <b>840.4</b>    | 600/55-26.5/20 | Rear                                                                              | Rear                                                                              |                                                                                   | Rear, *Rear                                                                        |                                                                                     |                                                                                     | *Rear                                                                               |                    |     | 550  | 80  | 550                               | 80  |
| <b>6 wheels</b> | 600/55R26.5    |                                                                                   |                                                                                   |                                                                                   |                                                                                    | Rear                                                                                |                                                                                     |                                                                                     |                    |     | 550  | 80  | 550                               | 80  |
|                 | 710/45R26.5    |                                                                                   |                                                                                   |                                                                                   |                                                                                    | Rear                                                                                |                                                                                     |                                                                                     |                    |     | 500  | 73  | 550                               | 80  |
|                 | 710/45-26.5/20 | Rear                                                                              | Rear                                                                              |                                                                                   | Rear, *Rear                                                                        |                                                                                     |                                                                                     | *Rear                                                                               |                    |     | 500  | 73  | 550                               | 80  |
|                 | 710/45-26.5/24 | Rear                                                                              |                                                                                   |                                                                                   | Rear                                                                               |                                                                                     |                                                                                     |                                                                                     |                    |     | 500  | 73  | 600                               | 87  |
|                 | 800/40-26.5/20 | Rear                                                                              | Rear                                                                              |                                                                                   | Rear                                                                               |                                                                                     |                                                                                     |                                                                                     |                    |     | 500  | 73  | 550                               | 80  |
|                 | 600/65-34/20   |                                                                                   |                                                                                   |                                                                                   |                                                                                    |                                                                                     |                                                                                     | *Front                                                                              | 350                | 51  |      |     | 360                               | 52  |
|                 | 600/65-34/24   |                                                                                   |                                                                                   | Front                                                                             |                                                                                    |                                                                                     |                                                                                     |                                                                                     | 350                | 51  |      |     | 400                               | 58  |
|                 | 600/65R34      |                                                                                   |                                                                                   |                                                                                   |                                                                                    | Front                                                                               |                                                                                     |                                                                                     | 350                | 51  |      |     | 400                               | 58  |
|                 | 700/55-34/20   |                                                                                   |                                                                                   |                                                                                   |                                                                                    |                                                                                     |                                                                                     | *Front                                                                              | 350                | 51  |      |     | 360                               | 52  |
|                 | 710/55-34/24   |                                                                                   |                                                                                   | Front                                                                             |                                                                                    |                                                                                     |                                                                                     |                                                                                     | 350                | 51  |      |     | 400                               | 58  |
|                 | 710/55R34      |                                                                                   |                                                                                   |                                                                                   |                                                                                    | Front                                                                               |                                                                                     |                                                                                     | 350                | 51  |      |     | 400                               | 58  |

| Machine              | Tire size / PR | Tread pattern                                                                     |                                                                                   |                                                                                   |                                                                                    |                                                                                     |                                                                                     |                                                                                     | Inflation pressure |     |      |     |                                   |     |
|----------------------|----------------|-----------------------------------------------------------------------------------|-----------------------------------------------------------------------------------|-----------------------------------------------------------------------------------|------------------------------------------------------------------------------------|-------------------------------------------------------------------------------------|-------------------------------------------------------------------------------------|-------------------------------------------------------------------------------------|--------------------|-----|------|-----|-----------------------------------|-----|
|                      |                |  |  |  |  |  |  |  | Front              |     | Rear |     | Max. inflation and track pressure |     |
|                      |                | F2                                                                                | TRS 2                                                                             | TRS 2+                                                                            | F<br>*Nordman F                                                                    | Rider                                                                               | ELS                                                                                 | TRS<br>*Nordman TRS                                                                 | kPa                | psi | kPa  | psi | kPa                               | psi |
| <b>845</b>           | 600/55-26.5/20 | Front, Rear                                                                       | Front, Rear                                                                       |                                                                                   | Front, Rear,<br>*Front, Rear                                                       |                                                                                     |                                                                                     | *Front, Rear                                                                        | 350                | 51  | 550  | 80  | 550                               | 80  |
| <b>8 wheels</b>      | 600/55R26.5    |                                                                                   |                                                                                   |                                                                                   |                                                                                    | Front, Rear                                                                         |                                                                                     |                                                                                     | 350                | 51  | 550  | 80  | 550                               | 80  |
|                      | 710/45R26.5    |                                                                                   |                                                                                   |                                                                                   |                                                                                    | Front, Rear                                                                         |                                                                                     |                                                                                     | 350                | 51  | 500  | 73  | 550                               | 80  |
|                      | 710/45-26.5/20 | Front, Rear                                                                       | Front, Rear                                                                       |                                                                                   | Front, Rear,<br>*Front, Rear                                                       |                                                                                     |                                                                                     | *Front, Rear                                                                        | 350                | 51  | 500  | 73  | 550                               | 80  |
|                      | 710/45-26.5/24 | Front, Rear                                                                       |                                                                                   |                                                                                   | Front, Rear                                                                        |                                                                                     |                                                                                     |                                                                                     | 350                | 51  | 500  | 73  | 600                               | 87  |
|                      | 800/40-26.5/20 | Front, Rear                                                                       | Front, Rear                                                                       |                                                                                   | Front, Rear                                                                        |                                                                                     |                                                                                     |                                                                                     | 350                | 51  | 500  | 73  | 550                               | 80  |
| <b>855.1 / 855.2</b> | 710/45R26.5    |                                                                                   |                                                                                   |                                                                                   |                                                                                    | Front, Rear                                                                         |                                                                                     |                                                                                     | 400                | 58  | 550  | 80  | 550                               | 80  |
| <b>8 wheels</b>      | 710/45-26.5/20 | Front, Rear                                                                       | Front, Rear                                                                       |                                                                                   | Front, Rear,<br>*Front, Rear                                                       |                                                                                     |                                                                                     | *Front, Rear                                                                        | 400                | 58  | 550  | 80  | 550                               | 80  |
|                      | 710/45-26.5/24 | Front, Rear                                                                       |                                                                                   |                                                                                   | Front, Rear                                                                        |                                                                                     |                                                                                     |                                                                                     | 400                | 58  | 550  | 80  | 600                               | 87  |
|                      | 800/40-26.5/20 | Front, Rear                                                                       | Front, Rear                                                                       |                                                                                   | Front, Rear                                                                        |                                                                                     |                                                                                     |                                                                                     | 400                | 58  | 550  | 80  | 550                               | 80  |
| <b>855.1 / 855.2</b> | 710/45R26.5    |                                                                                   |                                                                                   |                                                                                   |                                                                                    | Rear                                                                                |                                                                                     |                                                                                     |                    |     | 550  | 80  | 550                               | 80  |
| <b>6 wheels</b>      | 710/45-26.5/20 | Rear                                                                              | Rear                                                                              |                                                                                   | Rear, *Rear                                                                        |                                                                                     |                                                                                     | *Rear                                                                               |                    |     | 550  | 80  | 550                               | 80  |
|                      | 710/45-26.5/24 | Rear                                                                              |                                                                                   |                                                                                   | Rear                                                                               |                                                                                     |                                                                                     |                                                                                     |                    |     | 550  | 80  | 600                               | 87  |
|                      | 800/40-26.5/20 | Rear                                                                              | Rear                                                                              |                                                                                   | Rear                                                                               |                                                                                     |                                                                                     |                                                                                     |                    |     | 550  | 80  | 550                               | 80  |
|                      | 600/65-34/20   |                                                                                   |                                                                                   |                                                                                   |                                                                                    |                                                                                     |                                                                                     | *Front                                                                              | 350                | 51  |      |     | 360                               | 52  |
|                      | 600/65-34/24   |                                                                                   |                                                                                   | Front                                                                             |                                                                                    |                                                                                     |                                                                                     |                                                                                     | 350                | 51  |      |     | 400                               | 58  |
|                      | 600/65R34      |                                                                                   |                                                                                   |                                                                                   |                                                                                    | Front                                                                               |                                                                                     |                                                                                     | 350                | 51  |      |     | 400                               | 58  |
|                      | 700/55-34/20   |                                                                                   |                                                                                   |                                                                                   |                                                                                    |                                                                                     |                                                                                     | *Front                                                                              | 350                | 51  |      |     | 360                               | 52  |

| Machine         | Tire size / PR | Tread pattern                                                                     |                                                                                   |                                                                                   |                                                                                    |                                                                                     |                                                                                     |                                                                                     | Inflation pressure |     |      |     |                                   |     |
|-----------------|----------------|-----------------------------------------------------------------------------------|-----------------------------------------------------------------------------------|-----------------------------------------------------------------------------------|------------------------------------------------------------------------------------|-------------------------------------------------------------------------------------|-------------------------------------------------------------------------------------|-------------------------------------------------------------------------------------|--------------------|-----|------|-----|-----------------------------------|-----|
|                 |                |  |  |  |  |  |  |  | Front              |     | Rear |     | Max. inflation and track pressure |     |
|                 |                | F2                                                                                | TRS 2                                                                             | TRS 2+                                                                            | F<br>*Nordman F                                                                    | Rider                                                                               | ELS                                                                                 | TRS<br>*Nordman TRS                                                                 | kPa                | psi | kPa  | psi | kPa                               | psi |
|                 | 710/55-34/24   |                                                                                   |                                                                                   | Front                                                                             |                                                                                    |                                                                                     |                                                                                     |                                                                                     | 350                | 51  |      |     | 400                               | 58  |
|                 | 710/55R34      |                                                                                   |                                                                                   |                                                                                   |                                                                                    | Front                                                                               |                                                                                     |                                                                                     | 350                | 51  |      |     | 400                               | 58  |
| <b>860.4</b>    | 710/45-26.5/20 | Front, Rear                                                                       | Front, Rear                                                                       |                                                                                   | Front, Rear,<br>*Front, Rear                                                       |                                                                                     |                                                                                     | *Front, Rear                                                                        | 400                | 58  | 550  | 80  | 550                               | 80  |
| <b>8 wheels</b> | 710/45-26.5/24 | Front, Rear                                                                       |                                                                                   |                                                                                   | Front, Rear                                                                        |                                                                                     |                                                                                     |                                                                                     | 400                | 58  | 550  | 80  | 600                               | 87  |
|                 | 710/45R26.5    |                                                                                   |                                                                                   |                                                                                   |                                                                                    | Front, Rear                                                                         |                                                                                     |                                                                                     | 400                | 58  | 550  | 80  | 550                               | 80  |
|                 | 800/40-26.5/20 | Front, Rear                                                                       | Front, Rear                                                                       |                                                                                   | Front, Rear                                                                        |                                                                                     |                                                                                     |                                                                                     | 400                | 58  | 550  | 80  | 550                               | 80  |
| <b>860.4</b>    | 710/45-26.5/20 | Rear                                                                              | Rear                                                                              |                                                                                   | Rear, *Rear                                                                        |                                                                                     |                                                                                     | *Rear                                                                               |                    |     | 550  | 80  | 550                               | 80  |
| <b>6 wheels</b> | 710/45-26.5/24 | Rear                                                                              |                                                                                   |                                                                                   | Rear                                                                               |                                                                                     |                                                                                     |                                                                                     |                    |     | 600  | 87  | 600                               | 87  |
|                 | 710/45R26.5    |                                                                                   |                                                                                   |                                                                                   |                                                                                    | Rear                                                                                |                                                                                     |                                                                                     |                    |     | 550  | 80  | 550                               | 80  |
|                 | 800/40-26.5/20 | Rear                                                                              | Rear                                                                              |                                                                                   | Rear                                                                               |                                                                                     |                                                                                     |                                                                                     |                    |     | 550  | 80  | 550                               | 80  |
|                 | 600/65-34/20   |                                                                                   |                                                                                   |                                                                                   |                                                                                    |                                                                                     |                                                                                     | *Front                                                                              | 350                | 51  |      |     | 360                               | 52  |
|                 | 600/65-34/24   |                                                                                   |                                                                                   | Front                                                                             |                                                                                    |                                                                                     |                                                                                     |                                                                                     | 350                | 51  |      |     | 400                               | 58  |
|                 | 600/65R34      |                                                                                   |                                                                                   |                                                                                   |                                                                                    | Front                                                                               |                                                                                     |                                                                                     | 350                | 51  |      |     | 400                               | 58  |
|                 | 700/55-34/20   |                                                                                   |                                                                                   |                                                                                   |                                                                                    |                                                                                     |                                                                                     | *Front                                                                              | 350                | 51  |      |     | 360                               | 52  |
|                 | 710/55-34/24   |                                                                                   |                                                                                   | Front                                                                             |                                                                                    |                                                                                     |                                                                                     | *Front                                                                              | 350                | 51  |      |     | 400                               | 58  |
|                 | 710/55R34      |                                                                                   |                                                                                   |                                                                                   |                                                                                    | Front                                                                               |                                                                                     |                                                                                     | 350                | 51  |      |     | 400                               | 58  |
| <b>865</b>      | 710/45-26.5/20 | Front, Rear                                                                       | Front, Rear                                                                       |                                                                                   | Front, Rear,<br>*Front, Rear                                                       |                                                                                     |                                                                                     | *Front, Rear                                                                        | 400                | 58  | 550  | 80  | 550                               | 80  |
| <b>8 wheels</b> | 710/45-26.5/24 | Front, Rear                                                                       |                                                                                   |                                                                                   | Front, Rear                                                                        |                                                                                     |                                                                                     |                                                                                     | 400                | 58  | 600  | 87  | 600                               | 87  |
|                 | 710/45R26.5    |                                                                                   |                                                                                   |                                                                                   |                                                                                    | Front, Rear                                                                         |                                                                                     |                                                                                     | 400                | 58  | 550  | 80  | 550                               | 80  |







| Machine         | Tire size / PR | Tread pattern                                                                     |                                                                                   |                                                                                   |                                                                                    |                                                                                     |                                                                                     |                                                                                     | Inflation pressure |     |      |     |                                   |     |
|-----------------|----------------|-----------------------------------------------------------------------------------|-----------------------------------------------------------------------------------|-----------------------------------------------------------------------------------|------------------------------------------------------------------------------------|-------------------------------------------------------------------------------------|-------------------------------------------------------------------------------------|-------------------------------------------------------------------------------------|--------------------|-----|------|-----|-----------------------------------|-----|
|                 |                |  |  |  |  |  |  |  | Front              |     | Rear |     | Max. inflation and track pressure |     |
|                 |                | F2                                                                                | TRS 2                                                                             | TRS 2+                                                                            | F<br>*Nordman F                                                                    | Rider                                                                               | ELS                                                                                 | TRS<br>*Nordman TRS                                                                 | kPa                | psi | kPa  | psi | kPa                               | psi |
|                 | 800/40-26.5/20 | Front, Rear                                                                       | Front, Rear                                                                       |                                                                                   | Front, Rear                                                                        |                                                                                     |                                                                                     |                                                                                     | 400                | 58  | 550  | 80  | 550                               | 80  |
| <b>865</b>      | 710/45-26.5/20 | Rear                                                                              | Rear                                                                              |                                                                                   | Rear, *Rear                                                                        |                                                                                     |                                                                                     | *Rear                                                                               |                    |     | 550  | 80  | 550                               | 80  |
| <b>6 wheels</b> | 710/45-26.5/24 | Rear                                                                              |                                                                                   |                                                                                   | Rear                                                                               |                                                                                     |                                                                                     |                                                                                     |                    |     | 600  | 87  | 600                               | 87  |
|                 | 710/45R26.5    |                                                                                   |                                                                                   |                                                                                   |                                                                                    | Rear                                                                                |                                                                                     |                                                                                     |                    |     | 550  | 80  | 550                               | 80  |
|                 | 800/40-26.5/20 | Rear                                                                              | Rear                                                                              |                                                                                   | Rear                                                                               |                                                                                     |                                                                                     |                                                                                     |                    |     | 550  | 80  | 550                               | 80  |
|                 | 600/65-34/20   |                                                                                   |                                                                                   |                                                                                   |                                                                                    |                                                                                     |                                                                                     | *Front                                                                              | 350                | 51  |      |     | 360                               | 52  |
|                 | 600/65-34/24   |                                                                                   |                                                                                   | Front                                                                             |                                                                                    |                                                                                     |                                                                                     |                                                                                     | 350                | 51  |      |     | 400                               | 58  |
|                 | 600/65R34      |                                                                                   |                                                                                   |                                                                                   |                                                                                    | Front                                                                               |                                                                                     |                                                                                     | 350                | 51  |      |     | 400                               | 58  |
|                 | 700/55-34/20   |                                                                                   |                                                                                   |                                                                                   |                                                                                    |                                                                                     |                                                                                     | *Front                                                                              | 350                | 51  |      |     | 360                               | 52  |
|                 | 710/55-34/24   |                                                                                   |                                                                                   | Front                                                                             |                                                                                    |                                                                                     |                                                                                     |                                                                                     | 350                | 51  |      |     | 400                               | 58  |
|                 | 710/55R34      |                                                                                   |                                                                                   |                                                                                   |                                                                                    | Front                                                                               |                                                                                     |                                                                                     | 350                | 51  |      |     | 400                               | 58  |
| <b>875</b>      | 710/45-26.5/20 | Front, Rear                                                                       | Front, Rear                                                                       |                                                                                   | Front, Rear                                                                        |                                                                                     |                                                                                     |                                                                                     | 400                | 58  | 550  | 80  | 550                               | 80  |
| <b>8 wheels</b> | 710/45-26.5/24 | Front, Rear                                                                       |                                                                                   |                                                                                   | Front, Rear                                                                        |                                                                                     |                                                                                     |                                                                                     | 400                | 58  | 600  | 87  | 600                               | 87  |
|                 | 800/40-26.5/20 | Front, Rear                                                                       | Front, Rear                                                                       |                                                                                   | Front, Rear                                                                        |                                                                                     |                                                                                     |                                                                                     | 400                | 58  | 550  | 80  | 550                               | 80  |
| <b>875</b>      | 710/45-26.5/20 | Rear                                                                              | Rear                                                                              |                                                                                   | Rear                                                                               |                                                                                     |                                                                                     |                                                                                     |                    |     | 550  | 80  | 550                               |     |
| <b>6 wheels</b> | 710/45-26.5/24 | Rear                                                                              |                                                                                   |                                                                                   | Rear                                                                               |                                                                                     |                                                                                     |                                                                                     |                    |     | 600  | 87  | 600                               |     |
|                 | 800/40-26.5/20 | Rear                                                                              | Rear                                                                              |                                                                                   | Rear                                                                               |                                                                                     |                                                                                     |                                                                                     |                    |     | 550  | 80  | 550                               |     |
|                 | 700/55-34/20   |                                                                                   |                                                                                   |                                                                                   |                                                                                    |                                                                                     |                                                                                     | *Front                                                                              | 350                | 51  |      |     | 360                               |     |
|                 | 710/55-34/24   |                                                                                   |                                                                                   | Front                                                                             |                                                                                    |                                                                                     |                                                                                     |                                                                                     | 350                | 51  |      |     | 400                               |     |
|                 | 710/55R34      |                                                                                   |                                                                                   |                                                                                   |                                                                                    | Front                                                                               |                                                                                     |                                                                                     | 350                | 51  |      |     | 400                               |     |

| Machine              | Tire size / PR | Tread pattern                                                                     |                                                                                   |                                                                                   |                                                                                    |                                                                                     |                                                                                     |                                                                                     | Inflation pressure |     |      |     |                                   |     |
|----------------------|----------------|-----------------------------------------------------------------------------------|-----------------------------------------------------------------------------------|-----------------------------------------------------------------------------------|------------------------------------------------------------------------------------|-------------------------------------------------------------------------------------|-------------------------------------------------------------------------------------|-------------------------------------------------------------------------------------|--------------------|-----|------|-----|-----------------------------------|-----|
|                      |                |  |  |  |  |  |  |  | Front              |     | Rear |     | Max. inflation and track pressure |     |
|                      |                | F2                                                                                | TRS 2                                                                             | TRS 2+                                                                            | F<br>*Nordman F                                                                    | Rider                                                                               | ELS                                                                                 | TRS<br>*Nordman TRS                                                                 | kPa                | psi | kPa  | psi | kPa                               | psi |
| <b>890.3</b>         | 750/55-26.5/20 |                                                                                   |                                                                                   |                                                                                   | Front, Rear                                                                        |                                                                                     |                                                                                     | Front, Rear                                                                         | 450                | 65  | 550  | 80  | 550                               | 80  |
| <b>8 wheels</b>      | 750/55-26.5/24 | Front, Rear                                                                       | Front, Rear                                                                       |                                                                                   |                                                                                    |                                                                                     |                                                                                     |                                                                                     | 450                | 65  | 600  | 87  | 600                               | 87  |
|                      | 780/55-26.5/20 |                                                                                   |                                                                                   |                                                                                   | Front, Rear                                                                        |                                                                                     |                                                                                     |                                                                                     | 450                | 65  | 550  | 80  | 550                               | 80  |
|                      | 800/50R26.5    |                                                                                   |                                                                                   |                                                                                   |                                                                                    | Front, Rear                                                                         |                                                                                     |                                                                                     | 450                | 65  | 550  | 80  | 550                               | 80  |
| <b>890.3</b>         | 750/55-26.5/20 |                                                                                   |                                                                                   |                                                                                   | Rear, *Rear                                                                        |                                                                                     |                                                                                     | Rear, *Rear                                                                         |                    |     | 550  | 80  | 550                               | 80  |
| <b>6 wheels</b>      | 750/55-26.5/24 | Rear                                                                              | Rear                                                                              |                                                                                   |                                                                                    |                                                                                     |                                                                                     |                                                                                     |                    |     | 600  | 87  | 600                               | 87  |
|                      | 780/55-26.5/20 |                                                                                   |                                                                                   |                                                                                   | Rear                                                                               |                                                                                     |                                                                                     |                                                                                     |                    |     | 550  | 80  | 550                               | 80  |
|                      | 800/50R26.5    |                                                                                   |                                                                                   |                                                                                   |                                                                                    | Rear                                                                                |                                                                                     |                                                                                     |                    |     | 550  | 80  | 550                               | 80  |
|                      | 700/70-34/16   |                                                                                   |                                                                                   |                                                                                   |                                                                                    |                                                                                     |                                                                                     | Front                                                                               | 260                | 38  |      |     | 260                               | 38  |
|                      | 700/70-34/20   |                                                                                   |                                                                                   |                                                                                   |                                                                                    |                                                                                     |                                                                                     | *Front                                                                              | 350                | 51  |      |     | 360                               | 52  |
|                      | 710/70-34/24   |                                                                                   |                                                                                   | Front                                                                             |                                                                                    |                                                                                     |                                                                                     |                                                                                     | 350                | 51  |      |     | 400                               | 58  |
|                      | 710/70R34      |                                                                                   |                                                                                   |                                                                                   |                                                                                    | Front                                                                               |                                                                                     |                                                                                     | 350                | 51  |      |     | 400                               | 58  |
| <b>895, 8 wheels</b> | 780/50-28.5/24 | Front, Rear                                                                       | Front, Rear                                                                       |                                                                                   |                                                                                    |                                                                                     |                                                                                     |                                                                                     | 450                | 65  | 600  | 87  | 600                               | 87  |
| <b>895</b>           | 780/50-28.5/24 | Rear                                                                              | Rear                                                                              |                                                                                   |                                                                                    |                                                                                     |                                                                                     |                                                                                     |                    |     | 600  | 87  | 600                               | 87  |
| <b>6 wheels</b>      | 710/70-34/24   |                                                                                   |                                                                                   | Front                                                                             |                                                                                    |                                                                                     |                                                                                     |                                                                                     | 350                | 51  |      |     | 400                               | 58  |
|                      | 710/70R34      |                                                                                   |                                                                                   |                                                                                   |                                                                                    | Front                                                                               |                                                                                     |                                                                                     | 350                | 51  |      |     | 400                               | 58  |







## CAT FORWARDERS







| Machine         | Tire size / PR | Tread pattern                                                                     |                                                                                   |                                                                                   |                                                                                     | Inflation pressure |     |      |     |             |     |                                  |     |
|-----------------|----------------|-----------------------------------------------------------------------------------|-----------------------------------------------------------------------------------|-----------------------------------------------------------------------------------|-------------------------------------------------------------------------------------|--------------------|-----|------|-----|-------------|-----|----------------------------------|-----|
|                 |                |  |  |  |  | Front              |     | Rear |     | With tracks |     | Max inflation and track pressure |     |
|                 |                | F                                                                                 | Rider                                                                             | ELS                                                                               | TRS                                                                                 | kPa                | psi | kPa  | psi | kPa         | psi | kPa                              | psi |
| <b>584</b>      | 750/55-26.5/20 | Rear                                                                              |                                                                                   |                                                                                   | Rear                                                                                | 400                | 58  | 550  | 80  | 550         | 80  | 550                              | 80  |
| <b>6 wheels</b> | 780/55-26.5/20 | Rear                                                                              |                                                                                   |                                                                                   |                                                                                     | 400                | 58  | 550  | 80  | 550         | 80  | 550                              | 80  |
|                 | 800/50R26.5    |                                                                                   | Rear                                                                              |                                                                                   |                                                                                     | 400                | 58  | 550  | 80  | 550         | 80  | 550                              | 80  |
|                 | 700/70-34/16   |                                                                                   |                                                                                   |                                                                                   | Front                                                                               | 260                | 41  |      |     | 280         | 41  | 260                              | 41  |
| <b>584 8</b>    | 750/55-26.5/20 | Front, Rear                                                                       |                                                                                   |                                                                                   | Front, Rear                                                                         | 400                | 58  | 550  | 80  | 550         | 80  | 550                              | 80  |
| <b>8 wheels</b> | 780/55-26.5/20 | Front, Rear                                                                       |                                                                                   |                                                                                   |                                                                                     | 400                | 58  | 550  | 80  | 550         | 80  | 550                              | 80  |
|                 | 800/50R26.5    |                                                                                   | Front, Rear                                                                       |                                                                                   |                                                                                     | 400                | 58  | 550  | 80  | 550         | 80  | 550                              | 80  |
| <b>584 HD</b>   | 750/55-26.5/20 | Front, Rear                                                                       |                                                                                   |                                                                                   | Front, Rear                                                                         | 400                | 58  | 550  | 80  | 550         | 80  | 550                              | 80  |
| <b>8 wheels</b> | 780/55-26.5/20 | Front, Rear                                                                       |                                                                                   |                                                                                   |                                                                                     | 400                | 58  | 550  | 80  | 550         | 80  | 550                              | 80  |
|                 | 800/50R26.5    |                                                                                   | Front, Rear                                                                       |                                                                                   |                                                                                     | 400                | 58  | 550  | 80  | 550         | 80  | 550                              | 80  |

# JOHN DEERE HARVESTERS

| Machine         | Tire size / PR | Tread pattern                                                                     |                                                                                   |                                                                                   |                                                                                    |                                                                                     |                                                                                     |                                                                                     | Inflation pressure          |     |      |     |                                  |     |    |
|-----------------|----------------|-----------------------------------------------------------------------------------|-----------------------------------------------------------------------------------|-----------------------------------------------------------------------------------|------------------------------------------------------------------------------------|-------------------------------------------------------------------------------------|-------------------------------------------------------------------------------------|-------------------------------------------------------------------------------------|-----------------------------|-----|------|-----|----------------------------------|-----|----|
|                 |                |  |  |  |  |  |  |  | Front                       |     | Rear |     | Max inflation and track pressure |     |    |
|                 |                | F2                                                                                | TRS 2                                                                             | TRS 2+                                                                            | F<br>*Nordman F                                                                    | Rider                                                                               | ELS                                                                                 | TRS<br>*Nordman TRS                                                                 | kPa                         | psi | kPa  | psi | kPa                              | psi |    |
| <b>1070G</b>    | 650/60-26.5/20 |                                                                                   |                                                                                   |                                                                                   |                                                                                    |                                                                                     |                                                                                     | Front, Rear                                                                         | Front, Rear                 | 450 | 65   | 300 | 44                               | 550 | 80 |
| <b>4 wheels</b> | 750/55-26.5/20 |                                                                                   |                                                                                   |                                                                                   | Front, Rear<br>*Front, Rear                                                        |                                                                                     |                                                                                     |                                                                                     | Front, Rear<br>*Front, Rear | 450 | 65   | 300 | 44                               | 550 | 80 |
|                 | 750/55-26.5/24 | Front, Rear                                                                       | Front, Rear                                                                       |                                                                                   |                                                                                    |                                                                                     |                                                                                     |                                                                                     |                             | 450 | 65   | 300 | 44                               | 600 | 87 |
|                 | 600/65-34/20   |                                                                                   |                                                                                   |                                                                                   |                                                                                    |                                                                                     |                                                                                     |                                                                                     | *Front, Rear                | 320 | 46   | 280 | 41                               | 360 | 52 |
|                 | 600/65-34/24   |                                                                                   |                                                                                   | Front, Rear                                                                       |                                                                                    |                                                                                     |                                                                                     |                                                                                     |                             | 320 | 46   | 280 | 41                               | 400 | 58 |
|                 | 600/65R34      |                                                                                   |                                                                                   |                                                                                   |                                                                                    | Front, Rear                                                                         |                                                                                     |                                                                                     |                             | 320 | 46   | 280 | 41                               | 400 | 58 |
|                 | 700/55-34/20   |                                                                                   |                                                                                   |                                                                                   |                                                                                    |                                                                                     |                                                                                     |                                                                                     | *Front, Rear                | 320 | 46   | 280 | 41                               | 360 | 52 |
|                 | 710/55-34/24   |                                                                                   |                                                                                   | Front, Rear                                                                       |                                                                                    |                                                                                     |                                                                                     |                                                                                     |                             | 320 | 46   | 280 | 41                               | 400 | 58 |
|                 | 710/55R34      |                                                                                   |                                                                                   |                                                                                   |                                                                                    | Front, Rear                                                                         |                                                                                     |                                                                                     |                             | 320 | 46   | 280 | 41                               | 400 | 58 |
| <b>1070G</b>    | 600/50-22.5/16 |                                                                                   |                                                                                   |                                                                                   |                                                                                    |                                                                                     |                                                                                     | Front                                                                               |                             | 400 | 58   |     |                                  | 430 | 62 |
| <b>6 wheels</b> | 600/50-22.5/20 | Front                                                                             | Front                                                                             |                                                                                   |                                                                                    |                                                                                     |                                                                                     |                                                                                     |                             | 400 | 58   |     |                                  | 550 | 80 |
|                 | 710/40-22.5/16 |                                                                                   |                                                                                   |                                                                                   | Front                                                                              |                                                                                     |                                                                                     |                                                                                     |                             | 400 | 58   |     |                                  | 400 | 58 |
|                 | 710/40-22.5/20 | Front                                                                             | Front                                                                             |                                                                                   |                                                                                    |                                                                                     |                                                                                     |                                                                                     |                             | 400 | 58   |     |                                  | 550 | 80 |
|                 | 650/60-26.5/12 |                                                                                   |                                                                                   |                                                                                   |                                                                                    |                                                                                     |                                                                                     |                                                                                     | Rear                        |     |      | 280 | 41                               | 280 | 41 |
|                 | 650/60-26.5/20 |                                                                                   |                                                                                   |                                                                                   |                                                                                    |                                                                                     |                                                                                     | Rear                                                                                | Rear                        |     |      | 300 | 44                               | 550 | 80 |
|                 | 750/55-26.5/20 | Rear                                                                              |                                                                                   |                                                                                   | Rear, *Rear                                                                        |                                                                                     |                                                                                     |                                                                                     | Rear, *Rear                 |     |      | 300 | 44                               | 550 | 80 |
|                 | 600/65-34/20   |                                                                                   |                                                                                   |                                                                                   |                                                                                    |                                                                                     |                                                                                     |                                                                                     | *Rear                       |     |      | 280 | 41                               | 360 | 52 |
|                 | 600/65-34/24   |                                                                                   |                                                                                   | Rear                                                                              |                                                                                    |                                                                                     |                                                                                     |                                                                                     |                             |     |      | 280 | 41                               | 400 | 58 |









| Machine            | Tire size / PR | Tread pattern                                                                     |                                                                                   |                                                                                   |                                                                                    |                                                                                     |                                                                                     |                                                                                     | Inflation pressure |     |      |     |                                  |     |
|--------------------|----------------|-----------------------------------------------------------------------------------|-----------------------------------------------------------------------------------|-----------------------------------------------------------------------------------|------------------------------------------------------------------------------------|-------------------------------------------------------------------------------------|-------------------------------------------------------------------------------------|-------------------------------------------------------------------------------------|--------------------|-----|------|-----|----------------------------------|-----|
|                    |                |  |  |  |  |  |  |  | Front              |     | Rear |     | Max inflation and track pressure |     |
|                    |                | F2                                                                                | TRS 2                                                                             | TRS 2+                                                                            | F<br>*Nordman F                                                                    | Rider                                                                               | ELS                                                                                 | TRS<br>*Nordman TRS                                                                 | kPa                | psi | kPa  | psi | kPa                              | psi |
|                    | 600/65R34      |                                                                                   |                                                                                   |                                                                                   |                                                                                    |                                                                                     |                                                                                     |                                                                                     |                    |     | 280  | 41  | 400                              | 58  |
|                    | 700/55-34/20   |                                                                                   |                                                                                   |                                                                                   |                                                                                    |                                                                                     |                                                                                     |                                                                                     |                    |     | 280  | 41  | 360                              | 52  |
|                    | 710/55-34/24   |                                                                                   |                                                                                   | Rear                                                                              |                                                                                    |                                                                                     |                                                                                     |                                                                                     |                    |     | 280  | 41  | 400                              | 58  |
|                    | 710/55R34      |                                                                                   |                                                                                   |                                                                                   |                                                                                    | Rear                                                                                |                                                                                     |                                                                                     |                    |     | 280  | 41  | 400                              | 58  |
| <b>1170G 24.5"</b> | 600/50-24.5/20 |                                                                                   | Front                                                                             |                                                                                   |                                                                                    |                                                                                     |                                                                                     |                                                                                     | 450                | 65  |      |     | 550                              | 80  |
| <b>6 wheels</b>    | 650/45R24.5    |                                                                                   |                                                                                   |                                                                                   |                                                                                    | Front                                                                               |                                                                                     |                                                                                     | 450                | 65  |      |     | 550                              | 80  |
|                    | 710/40-24.5/20 | Front                                                                             | Front                                                                             |                                                                                   | Front, *Front                                                                      |                                                                                     |                                                                                     |                                                                                     | 450                | 65  |      |     | 550                              | 80  |
|                    | 800/40-24.5/20 | Front                                                                             | Front                                                                             |                                                                                   |                                                                                    |                                                                                     |                                                                                     |                                                                                     | 450                | 65  |      |     | 550                              | 80  |
|                    | 600/65-34/20   |                                                                                   |                                                                                   |                                                                                   |                                                                                    |                                                                                     |                                                                                     |                                                                                     |                    |     | 300  | 44  | 360                              | 52  |
|                    | 600/65-34/24   |                                                                                   |                                                                                   | Rear                                                                              |                                                                                    |                                                                                     |                                                                                     |                                                                                     |                    |     | 300  | 44  | 400                              | 58  |
|                    | 600/65R34      |                                                                                   |                                                                                   |                                                                                   |                                                                                    | Rear                                                                                |                                                                                     |                                                                                     |                    |     | 300  | 44  | 400                              | 58  |
|                    | 700/55-34/20   |                                                                                   |                                                                                   |                                                                                   |                                                                                    |                                                                                     |                                                                                     |                                                                                     |                    |     | 300  | 44  | 360                              | 52  |
|                    | 710/55-34/24   |                                                                                   |                                                                                   | Rear                                                                              |                                                                                    |                                                                                     |                                                                                     |                                                                                     |                    |     | 300  | 44  | 400                              | 58  |
|                    | 710/55R34      |                                                                                   |                                                                                   |                                                                                   |                                                                                    | Rear                                                                                |                                                                                     |                                                                                     |                    |     | 300  | 44  | 400                              | 58  |
| <b>1170G 24.5"</b> | 600/50-24.5    |                                                                                   | Front, Rear                                                                       |                                                                                   |                                                                                    |                                                                                     |                                                                                     |                                                                                     | 450                | 65  | 400  | 58  | 550                              | 80  |
| <b>8 wheels</b>    | 650/45R24.5    |                                                                                   |                                                                                   |                                                                                   |                                                                                    | Front                                                                               |                                                                                     |                                                                                     | 450                | 65  | 400  | 58  | 550                              | 80  |
|                    | 710/40-24.5/20 | Front, Rear                                                                       | Front, Rear                                                                       |                                                                                   | Front, Rear<br>*Front, Rear                                                        |                                                                                     |                                                                                     |                                                                                     | 450                | 65  | 400  | 58  | 550                              | 80  |
|                    | 800/40-24.5/20 | Front, Rear                                                                       | Front, Rear                                                                       |                                                                                   |                                                                                    |                                                                                     |                                                                                     |                                                                                     | 450                | 65  | 400  | 58  | 550                              | 80  |
| <b>1170G 26.5"</b> | 600/55-26.5/20 | Front                                                                             | Front                                                                             |                                                                                   | Front, *Front                                                                      |                                                                                     |                                                                                     |                                                                                     | 500                | 73  |      |     | 550                              | 80  |

| Machine         | Tire size / PR | Tread pattern                                                                     |                                                                                   |                                                                                   |                                                                                    |                                                                                     |                                                                                     |                                                                                     | Inflation pressure |     |      |     |                                  |     |
|-----------------|----------------|-----------------------------------------------------------------------------------|-----------------------------------------------------------------------------------|-----------------------------------------------------------------------------------|------------------------------------------------------------------------------------|-------------------------------------------------------------------------------------|-------------------------------------------------------------------------------------|-------------------------------------------------------------------------------------|--------------------|-----|------|-----|----------------------------------|-----|
|                 |                |  |  |  |  |  |  |  | Front              |     | Rear |     | Max inflation and track pressure |     |
|                 |                | F2                                                                                | TRS 2                                                                             | TRS 2+                                                                            | F<br>*Nordman F                                                                    | Rider                                                                               | ELS                                                                                 | TRS<br>*Nordman TRS                                                                 | kPa                | psi | kPa  | psi | kPa                              | psi |
| <b>6 wheels</b> | 710/45-26.5/20 | Front                                                                             | Front                                                                             |                                                                                   | Front, *Front                                                                      |                                                                                     |                                                                                     | *Front                                                                              | 500                | 73  |      |     | 550                              | 80  |
|                 | 710/45-26.5/24 | Front                                                                             |                                                                                   |                                                                                   | Front                                                                              |                                                                                     |                                                                                     |                                                                                     | 500                | 73  |      |     | 600                              | 87  |
|                 | 800/40-26.5/20 | Front                                                                             | Front                                                                             |                                                                                   | Front                                                                              |                                                                                     |                                                                                     |                                                                                     | 500                | 73  |      |     | 500                              | 73  |
|                 | 600/65-34/20   |                                                                                   |                                                                                   |                                                                                   |                                                                                    |                                                                                     |                                                                                     | *Rear                                                                               |                    |     | 300  | 44  | 360                              | 52  |
|                 | 600/65-34/24   |                                                                                   |                                                                                   | Rear                                                                              |                                                                                    |                                                                                     |                                                                                     |                                                                                     |                    |     | 300  | 44  | 400                              | 58  |
|                 | 600/65R34      |                                                                                   |                                                                                   |                                                                                   |                                                                                    | Rear                                                                                |                                                                                     |                                                                                     |                    |     | 300  | 44  | 400                              | 58  |
|                 | 700/55-34/20   |                                                                                   |                                                                                   |                                                                                   |                                                                                    |                                                                                     |                                                                                     | *Rear                                                                               |                    |     | 300  | 44  | 360                              | 52  |
|                 | 710/55-34/24   |                                                                                   |                                                                                   | Rear                                                                              |                                                                                    |                                                                                     |                                                                                     |                                                                                     |                    |     | 300  | 44  | 400                              | 58  |
|                 | 710/55R34      |                                                                                   |                                                                                   |                                                                                   |                                                                                    | Rear                                                                                |                                                                                     |                                                                                     |                    |     | 300  | 44  | 400                              | 58  |
| <b>1270G</b>    | 600/55-26.5/20 | Front                                                                             | Front                                                                             |                                                                                   | Front, *Front                                                                      |                                                                                     |                                                                                     | *Front                                                                              | 500                | 73  |      |     | 550                              | 80  |
| <b>6 wheels</b> | 600/55R26.5    |                                                                                   |                                                                                   |                                                                                   |                                                                                    | Front                                                                               |                                                                                     | *Front                                                                              | 500                | 73  |      |     | 550                              | 80  |
|                 | 710/45-26.5/20 | Front                                                                             | Front                                                                             |                                                                                   | Front, *Front                                                                      |                                                                                     |                                                                                     | *Front                                                                              | 500                | 73  |      |     | 550                              | 80  |
|                 | 710/45R26.5    |                                                                                   |                                                                                   |                                                                                   |                                                                                    | Front                                                                               |                                                                                     | *Front                                                                              | 500                | 73  |      |     | 550                              | 80  |
|                 | 710/45-26.5/24 | Front                                                                             |                                                                                   |                                                                                   | Front                                                                              |                                                                                     |                                                                                     |                                                                                     | 500                | 73  |      |     | 600                              | 87  |
|                 | 800/40-26.5/20 | Front                                                                             | Front                                                                             |                                                                                   | Front                                                                              |                                                                                     |                                                                                     |                                                                                     | 500                | 73  |      |     | 500                              | 73  |
|                 | 600/65-34/20   |                                                                                   |                                                                                   |                                                                                   |                                                                                    |                                                                                     |                                                                                     | *Rear                                                                               |                    |     | 300  | 44  | 360                              | 52  |
|                 | 600/65-34/24   |                                                                                   |                                                                                   | Rear                                                                              |                                                                                    |                                                                                     |                                                                                     |                                                                                     |                    |     | 300  | 44  | 400                              | 58  |
|                 | 600/65R34      |                                                                                   |                                                                                   |                                                                                   |                                                                                    | Rear                                                                                |                                                                                     |                                                                                     |                    |     | 300  | 44  | 400                              | 58  |
|                 | 700/55-34/20   |                                                                                   |                                                                                   |                                                                                   |                                                                                    |                                                                                     |                                                                                     | *Rear                                                                               |                    |     | 300  | 44  | 360                              | 52  |
| 710/55-34/24    |                |                                                                                   | Rear                                                                              |                                                                                   |                                                                                    |                                                                                     |                                                                                     |                                                                                     |                    | 300 | 44   | 400 | 58                               |     |









| Machine         | Tire size / PR | Tread pattern                                                                     |                                                                                   |                                                                                   |                                                                                    |                                                                                     |                                                                                     |                                                                                     | Inflation pressure |     |      |     |                                  |     |
|-----------------|----------------|-----------------------------------------------------------------------------------|-----------------------------------------------------------------------------------|-----------------------------------------------------------------------------------|------------------------------------------------------------------------------------|-------------------------------------------------------------------------------------|-------------------------------------------------------------------------------------|-------------------------------------------------------------------------------------|--------------------|-----|------|-----|----------------------------------|-----|
|                 |                |  |  |  |  |  |  |  | Front              |     | Rear |     | Max inflation and track pressure |     |
|                 |                | F2                                                                                | TRS 2                                                                             | TRS 2+                                                                            | F<br>*Nordman F                                                                    | Rider                                                                               | ELS                                                                                 | TRS<br>*Nordman TRS                                                                 | kPa                | psi | kPa  | psi | kPa                              | psi |
|                 | 710/55R34      |                                                                                   |                                                                                   |                                                                                   |                                                                                    | Rear                                                                                |                                                                                     |                                                                                     |                    |     | 300  | 44  | 400                              | 58  |
| <b>1270G</b>    | 600/55-26.5/20 | Front.Rear                                                                        | Front.Rear                                                                        |                                                                                   | Front.Rear<br>*Front.Rear                                                          |                                                                                     |                                                                                     | *Front.Rear                                                                         | 500                | 73  | 400  | 58  | 550                              | 80  |
| <b>6 wheels</b> | 600/55R26.5    |                                                                                   |                                                                                   |                                                                                   |                                                                                    | Front.Rear                                                                          |                                                                                     |                                                                                     | 500                | 73  | 400  | 58  | 550                              | 80  |
|                 | 710/45-26.5/20 | Front.Rear                                                                        | Front.Rear                                                                        |                                                                                   | Front.Rear<br>*Front.Rear                                                          |                                                                                     |                                                                                     | *Front.Rear                                                                         | 500                | 73  | 400  | 58  | 550                              | 80  |
|                 | 710/45R26.5    |                                                                                   |                                                                                   |                                                                                   |                                                                                    | Front.Rear                                                                          |                                                                                     |                                                                                     | 500                | 73  | 400  | 58  | 550                              | 80  |
|                 | 710/45-26.5/24 | Front.Rear                                                                        |                                                                                   |                                                                                   | Front.Rear                                                                         |                                                                                     |                                                                                     |                                                                                     | 500                | 73  | 400  | 58  | 600                              | 87  |
|                 | 800/40-26.5/20 | Front.Rear                                                                        | Front.Rear                                                                        |                                                                                   | Front.Rear                                                                         |                                                                                     |                                                                                     |                                                                                     | 500                | 73  | 400  | 58  | 500                              | 73  |
| <b>1470G</b>    | 650/65-26.5/20 |                                                                                   |                                                                                   |                                                                                   |                                                                                    |                                                                                     | Front                                                                               | Front                                                                               | 500                | 73  |      |     | 550                              | 80  |
| <b>6 wheels</b> | 750/55-26.5/20 |                                                                                   |                                                                                   |                                                                                   | Front, *Front                                                                      |                                                                                     |                                                                                     | Front, *Front                                                                       | 500                | 73  |      |     | 550                              | 80  |
|                 | 750/55-26.5/24 | Front                                                                             | Front                                                                             |                                                                                   |                                                                                    |                                                                                     |                                                                                     |                                                                                     | 500                | 73  |      |     | 600                              | 87  |
|                 | 780/55-26.5/20 |                                                                                   |                                                                                   |                                                                                   | Front                                                                              |                                                                                     |                                                                                     |                                                                                     | 500                | 73  |      |     | 600                              | 87  |
|                 | 710/55-28.5/24 | Front                                                                             | Front                                                                             |                                                                                   | Front                                                                              |                                                                                     |                                                                                     |                                                                                     | 500                | 73  |      |     | 600                              | 87  |
|                 | 780/50-28.5/24 | Front                                                                             | Front                                                                             |                                                                                   |                                                                                    |                                                                                     |                                                                                     |                                                                                     | 500                | 73  |      |     | 600                              | 87  |
|                 | 700/70-34/16   |                                                                                   |                                                                                   |                                                                                   |                                                                                    |                                                                                     |                                                                                     | Rear                                                                                |                    |     | 260  | 38  | 260                              | 38  |
|                 | 700/70-34/20   |                                                                                   |                                                                                   |                                                                                   |                                                                                    |                                                                                     |                                                                                     | *Rear                                                                               |                    |     | 300  | 44  | 360                              | 52  |
|                 | 710/70-34/24   |                                                                                   |                                                                                   | Rear                                                                              |                                                                                    |                                                                                     |                                                                                     |                                                                                     |                    |     | 300  | 44  | 400                              | 58  |
|                 | 710/70R34      |                                                                                   |                                                                                   |                                                                                   |                                                                                    | Rear                                                                                |                                                                                     |                                                                                     |                    |     | 300  | 44  | 400                              | 58  |



# JOHN DEERE FORWARDERS









| Machine                | Tire size / PR | Tread pattern                                                                     |                                                                                   |                                                                                   |                                                                                    |                                                                                     |                                                                                     | Inflation pressure                                                                  |     |      |     |                                  |    |
|------------------------|----------------|-----------------------------------------------------------------------------------|-----------------------------------------------------------------------------------|-----------------------------------------------------------------------------------|------------------------------------------------------------------------------------|-------------------------------------------------------------------------------------|-------------------------------------------------------------------------------------|-------------------------------------------------------------------------------------|-----|------|-----|----------------------------------|----|
|                        |                |  |  |  |  |  |  |  |     |      |     |                                  |    |
|                        |                | F2                                                                                | TRS 2                                                                             | TRS 2+                                                                            | F<br>*Nordman F                                                                    | Rider                                                                               | TRS<br>*Nordman TRS                                                                 | Front                                                                               |     | Rear |     | Max inflation and track pressure |    |
|                        |                |                                                                                   |                                                                                   |                                                                                   |                                                                                    |                                                                                     | kPa                                                                                 | psi                                                                                 | kPa | psi  | kPa | psi                              |    |
| <b>810E</b>            | 600/50-22.5/20 | Front, Rear                                                                       | Front, Rear                                                                       |                                                                                   |                                                                                    |                                                                                     | Front, Rear                                                                         | 300                                                                                 | 44  | 500  | 73  | 550                              | 80 |
| <b>8 wheels</b>        | 710/40-22.5/16 |                                                                                   |                                                                                   |                                                                                   | Front, Rear                                                                        |                                                                                     | Front, Rear                                                                         | 300                                                                                 | 44  | 400  | 58  | 400                              | 58 |
|                        | 710/40-22.5/20 | Front, Rear                                                                       | Front, Rear                                                                       |                                                                                   |                                                                                    |                                                                                     |                                                                                     | 300                                                                                 | 44  | 500  | 73  | 550                              | 80 |
| <b>910G 22.5"</b>      | 600/50-22.5/20 | Front, Rear                                                                       | Front, Rear                                                                       |                                                                                   |                                                                                    |                                                                                     | Front, Rear                                                                         | 300                                                                                 | 44  | 500  | 73  | 550                              | 80 |
| <b>8 wheels</b>        | 710/40-22.5/16 |                                                                                   |                                                                                   |                                                                                   | Front, Rear                                                                        |                                                                                     | Front, Rear                                                                         | 300                                                                                 | 44  | 400  | 58  | 400                              | 58 |
|                        | 710/40-22.5/20 | Front, Rear                                                                       | Front, Rear                                                                       |                                                                                   |                                                                                    |                                                                                     |                                                                                     | 300                                                                                 | 44  | 500  | 73  | 550                              | 80 |
| <b>910/1010G 24.5"</b> | 600/50-24.5    |                                                                                   | Rear                                                                              |                                                                                   |                                                                                    |                                                                                     |                                                                                     |                                                                                     |     | 550  | 80  | 550                              | 80 |
| <b>6 wheels</b>        | 650/45R24.5    |                                                                                   |                                                                                   |                                                                                   |                                                                                    | Rear                                                                                |                                                                                     |                                                                                     |     | 550  | 80  | 550                              | 80 |
|                        | 710/40-24.5/20 | Rear                                                                              | Rear                                                                              |                                                                                   | Rear                                                                               |                                                                                     |                                                                                     |                                                                                     |     | 500  | 73  | 550                              | 80 |
|                        | 800/40-24.5/20 | Rear                                                                              | Rear                                                                              |                                                                                   |                                                                                    |                                                                                     |                                                                                     |                                                                                     |     | 500  | 73  | 550                              | 80 |
|                        | 600/65-34/20   |                                                                                   |                                                                                   |                                                                                   |                                                                                    |                                                                                     | *Front                                                                              | 300                                                                                 | 44  |      |     | 360                              | 52 |
|                        | 600/65-34/24   |                                                                                   |                                                                                   | Front                                                                             |                                                                                    |                                                                                     |                                                                                     | 300                                                                                 | 44  |      |     | 400                              | 58 |
|                        | 600/65R34      |                                                                                   |                                                                                   |                                                                                   |                                                                                    | Front                                                                               |                                                                                     | 300                                                                                 | 44  |      |     | 400                              | 58 |
|                        | 700/55-34/20   |                                                                                   |                                                                                   |                                                                                   |                                                                                    |                                                                                     | *Front                                                                              | 300                                                                                 | 44  |      |     | 360                              | 52 |
|                        | 710/55-34/24   |                                                                                   |                                                                                   | Front                                                                             |                                                                                    |                                                                                     |                                                                                     | 300                                                                                 | 44  |      |     | 400                              | 58 |

| Machine                | Tire size / PR | Tread pattern                                                                     |                                                                                   |                                                                                   |                                                                                    |                                                                                     |                                                                                     | Inflation pressure                                                                  |     |                                                                                     |     |                                  |     |
|------------------------|----------------|-----------------------------------------------------------------------------------|-----------------------------------------------------------------------------------|-----------------------------------------------------------------------------------|------------------------------------------------------------------------------------|-------------------------------------------------------------------------------------|-------------------------------------------------------------------------------------|-------------------------------------------------------------------------------------|-----|-------------------------------------------------------------------------------------|-----|----------------------------------|-----|
|                        |                |  |  |  |  |  |  |  |     |  |     | Max inflation and track pressure |     |
|                        |                | F2                                                                                | TRS 2                                                                             | TRS 2+                                                                            | F<br>*Nordman F                                                                    | Rider                                                                               | TRS<br>*Nordman TRS                                                                 | kPa                                                                                 | psi | kPa                                                                                 | psi | kPa                              | psi |
|                        | 710/55R34      |                                                                                   |                                                                                   |                                                                                   |                                                                                    | Front                                                                               |                                                                                     |                                                                                     |     |                                                                                     |     |                                  |     |
|                        | 28L-26/26      |                                                                                   |                                                                                   |                                                                                   |                                                                                    |                                                                                     | Front                                                                               | 300                                                                                 | 44  |                                                                                     |     | 420                              | 61  |
| <b>910/1010G 24.5"</b> | 600/50-24.5    |                                                                                   |                                                                                   |                                                                                   |                                                                                    |                                                                                     |                                                                                     |                                                                                     |     |                                                                                     |     |                                  |     |
| <b>8 wheels</b>        | 650/45R24.5    |                                                                                   |                                                                                   |                                                                                   |                                                                                    | Front, Rear                                                                         |                                                                                     |                                                                                     |     |                                                                                     |     |                                  |     |
|                        | 710/40-24.5/20 | Front, Rear                                                                       | Front, Rear                                                                       |                                                                                   | Front, Rear*<br>Front, Rear                                                        |                                                                                     |                                                                                     |                                                                                     |     |                                                                                     |     |                                  |     |
|                        | 800/40-24.5/20 | Front, Rear                                                                       | Front, Rear                                                                       |                                                                                   |                                                                                    |                                                                                     |                                                                                     |                                                                                     |     |                                                                                     |     |                                  |     |
| <b>1010G 26.5"</b>     | 600/55-26.5/20 | Front, Rear                                                                       | Front, Rear                                                                       |                                                                                   | Front, Rear*<br>Front, Rear                                                        |                                                                                     | *Front, Rear                                                                        | 400                                                                                 | 58  | 550                                                                                 | 80  | 550                              | 80  |
| <b>8 wheels</b>        | 600/55R26.5    |                                                                                   |                                                                                   |                                                                                   |                                                                                    | Front, Rear                                                                         |                                                                                     |                                                                                     |     |                                                                                     |     |                                  |     |
|                        | 710/45-26.5/20 | Front, Rear                                                                       | Front, Rear                                                                       |                                                                                   | Front, Rear*<br>Front, Rear                                                        |                                                                                     | Front, Rear<br>*Front, Rear                                                         | 400                                                                                 | 58  | 500                                                                                 | 73  | 550                              | 80  |
|                        | 710/45-26.5/24 | Front, Rear                                                                       |                                                                                   |                                                                                   | Front, Rear                                                                        |                                                                                     |                                                                                     | 400                                                                                 | 58  | 500                                                                                 | 73  | 600                              | 87  |
|                        | 710/45R26.5    |                                                                                   |                                                                                   |                                                                                   |                                                                                    | Front, Rear                                                                         |                                                                                     |                                                                                     |     |                                                                                     |     |                                  |     |
|                        | 800/40-26.5/20 | Front, Rear                                                                       | Front, Rear                                                                       |                                                                                   | Front, Rear                                                                        |                                                                                     |                                                                                     | 400                                                                                 | 58  | 500                                                                                 | 73  | 500                              | 74  |
| <b>1010G 26.5"</b>     | 600/55-26.5/20 | Rear                                                                              | Rear                                                                              |                                                                                   | Rear, *Rear                                                                        |                                                                                     | *Rear                                                                               |                                                                                     |     | 550                                                                                 | 80  | 550                              | 80  |
| <b>6 wheels</b>        | 600/55R26.5    |                                                                                   |                                                                                   |                                                                                   |                                                                                    | Rear                                                                                |                                                                                     |                                                                                     |     | 550                                                                                 | 80  | 550                              | 80  |
|                        | 710/45-26.5/20 | Rear                                                                              | Rear                                                                              |                                                                                   | Rear, *Rear                                                                        |                                                                                     | *Rear                                                                               |                                                                                     |     | 500                                                                                 | 73  | 550                              | 80  |

| Machine         | Tire size / PR | Tread pattern                                                                     |                                                                                   |                                                                                   |                                                                                    |                                                                                     |                                                                                     | Inflation pressure                                                                  |     |                                                                                     |     |                                  |     |
|-----------------|----------------|-----------------------------------------------------------------------------------|-----------------------------------------------------------------------------------|-----------------------------------------------------------------------------------|------------------------------------------------------------------------------------|-------------------------------------------------------------------------------------|-------------------------------------------------------------------------------------|-------------------------------------------------------------------------------------|-----|-------------------------------------------------------------------------------------|-----|----------------------------------|-----|
|                 |                |  |  |  |  |  |  |  |     |  |     | Max inflation and track pressure |     |
|                 |                | F2                                                                                | TRS 2                                                                             | TRS 2+                                                                            | F<br>*Nordman F                                                                    | Rider                                                                               | TRS<br>*Nordman TRS                                                                 | kPa                                                                                 | psi | kPa                                                                                 | psi | kPa                              | psi |
|                 | 710/45-26.5/24 | Rear                                                                              |                                                                                   |                                                                                   | Rear                                                                               |                                                                                     |                                                                                     |                                                                                     |     | 500                                                                                 | 73  | 550                              | 80  |
|                 | 710/45R26.5    |                                                                                   |                                                                                   |                                                                                   |                                                                                    | Rear                                                                                |                                                                                     |                                                                                     |     | 500                                                                                 | 73  | 550                              | 80  |
|                 | 800/40-26.5/20 | Rear                                                                              | Rear                                                                              |                                                                                   | Rear                                                                               |                                                                                     |                                                                                     |                                                                                     |     | 500                                                                                 | 73  | 500                              | 73  |
|                 | 600/65-34/20   |                                                                                   |                                                                                   |                                                                                   |                                                                                    |                                                                                     | *Front                                                                              | 300                                                                                 | 44  |                                                                                     |     | 360                              | 52  |
|                 | 600/65-34/24   |                                                                                   |                                                                                   | Front                                                                             |                                                                                    |                                                                                     |                                                                                     | 300                                                                                 | 44  |                                                                                     |     | 400                              | 58  |
|                 | 600/65R34      |                                                                                   |                                                                                   |                                                                                   | Front                                                                              |                                                                                     |                                                                                     | 300                                                                                 | 44  |                                                                                     |     | 400                              | 58  |
|                 | 700/55-34/20   |                                                                                   |                                                                                   |                                                                                   |                                                                                    |                                                                                     | *Front                                                                              | 300                                                                                 | 44  |                                                                                     |     | 360                              | 52  |
|                 | 710/55-34/24   |                                                                                   |                                                                                   | Front                                                                             |                                                                                    |                                                                                     |                                                                                     | 300                                                                                 | 44  |                                                                                     |     | 400                              | 58  |
|                 | 710/55R34      |                                                                                   |                                                                                   |                                                                                   | Front                                                                              |                                                                                     |                                                                                     | 300                                                                                 | 44  |                                                                                     |     | 400                              | 58  |
|                 | 28L-26/26      |                                                                                   |                                                                                   |                                                                                   |                                                                                    |                                                                                     | Front                                                                               | 300                                                                                 | 44  |                                                                                     |     | 420                              | 61  |
| <b>1110G</b>    | 600/55-26.5/20 | Front, Rear                                                                       | Front, Rear                                                                       |                                                                                   | Front, Rear<br>*Front, Rear                                                        |                                                                                     | *Front, Rear                                                                        | 400                                                                                 | 58  | 550                                                                                 | 80  | 550                              | 80  |
| <b>8 wheels</b> | 600/55R26.5    |                                                                                   |                                                                                   |                                                                                   |                                                                                    | Front, Rear                                                                         |                                                                                     | 400                                                                                 | 58  | 550                                                                                 | 80  | 550                              | 80  |
|                 | 710/45-26.5/20 | Front, Rear                                                                       | Front, Rear                                                                       |                                                                                   | Front, Rear<br>*Front, Rear                                                        |                                                                                     | Front, Rear<br>*Front, Rear                                                         | 400                                                                                 | 58  | 500                                                                                 | 73  | 550                              | 80  |
|                 | 710/45-26.5/24 | Front, Rear                                                                       |                                                                                   |                                                                                   | Front, Rear                                                                        |                                                                                     |                                                                                     | 400                                                                                 | 58  | 500                                                                                 | 73  | 600                              | 87  |
|                 | 710/45R26.5    |                                                                                   |                                                                                   |                                                                                   |                                                                                    | Front, Rear                                                                         |                                                                                     | 400                                                                                 | 58  | 500                                                                                 | 73  | 550                              | 80  |
|                 | 800/40-26.5/20 | Front, Rear                                                                       | Front, Rear                                                                       |                                                                                   | Front, Rear                                                                        |                                                                                     |                                                                                     | 400                                                                                 | 58  | 500                                                                                 | 73  | 500                              | 73  |







| Machine         | Tire size / PR | Tread pattern                                                                     |                                                                                   |                                                                                   |                                                                                    |                                                                                     |                                                                                     | Inflation pressure                                                                  |     |                                                                                     |     |                                  |     |
|-----------------|----------------|-----------------------------------------------------------------------------------|-----------------------------------------------------------------------------------|-----------------------------------------------------------------------------------|------------------------------------------------------------------------------------|-------------------------------------------------------------------------------------|-------------------------------------------------------------------------------------|-------------------------------------------------------------------------------------|-----|-------------------------------------------------------------------------------------|-----|----------------------------------|-----|
|                 |                |  |  |  |  |  |  |  |     |  |     | Max inflation and track pressure |     |
|                 |                | F2                                                                                | TRS 2                                                                             | TRS 2+                                                                            | F<br>*Nordman F                                                                    | Rider                                                                               | TRS<br>*Nordman TRS                                                                 | kPa                                                                                 | psi | kPa                                                                                 | psi | kPa                              | psi |
| <b>1110G</b>    | 600/55-26.5/20 | Rear                                                                              | Rear                                                                              |                                                                                   | Rear, *Rear                                                                        |                                                                                     | *Rear                                                                               |                                                                                     |     | 550                                                                                 | 80  | 550                              | 80  |
| <b>6 wheels</b> | 600/55R26.5    |                                                                                   |                                                                                   |                                                                                   |                                                                                    | Rear                                                                                |                                                                                     |                                                                                     |     | 550                                                                                 | 80  | 550                              | 80  |
|                 | 710/45-26.5/20 | Rear                                                                              | Rear                                                                              |                                                                                   | Rear, *Rear                                                                        |                                                                                     | *Rear                                                                               |                                                                                     |     | 500                                                                                 | 73  | 550                              | 80  |
|                 | 710/45-26.5/24 | Rear                                                                              |                                                                                   |                                                                                   | Rear                                                                               |                                                                                     |                                                                                     |                                                                                     |     | 500                                                                                 | 73  | 550                              | 80  |
|                 | 710/45R26.5    |                                                                                   |                                                                                   |                                                                                   |                                                                                    | Rear                                                                                |                                                                                     |                                                                                     |     | 500                                                                                 | 73  | 550                              | 80  |
|                 | 800/40-26.5/20 | Rear                                                                              | Rear                                                                              |                                                                                   | Rear                                                                               |                                                                                     |                                                                                     |                                                                                     |     | 500                                                                                 | 73  | 500                              | 73  |
|                 | 600/65-34/20   |                                                                                   |                                                                                   |                                                                                   |                                                                                    |                                                                                     | *Front                                                                              | 300                                                                                 | 44  |                                                                                     |     | 360                              | 52  |
|                 | 600/65-34/24   |                                                                                   |                                                                                   | Front                                                                             |                                                                                    |                                                                                     |                                                                                     | 300                                                                                 | 44  |                                                                                     |     | 400                              | 58  |
|                 | 600/65R34      |                                                                                   |                                                                                   |                                                                                   |                                                                                    | Front                                                                               |                                                                                     | 300                                                                                 | 44  |                                                                                     |     | 400                              | 58  |
|                 | 700/55-34/20   |                                                                                   |                                                                                   |                                                                                   |                                                                                    |                                                                                     | *Front                                                                              | 300                                                                                 | 44  |                                                                                     |     | 360                              | 52  |
|                 | 710/55-34/24   |                                                                                   |                                                                                   | Front                                                                             |                                                                                    |                                                                                     |                                                                                     | 300                                                                                 | 44  |                                                                                     |     | 400                              | 58  |
|                 | 710/55R34      |                                                                                   |                                                                                   |                                                                                   |                                                                                    | Front                                                                               |                                                                                     | 300                                                                                 | 44  |                                                                                     |     | 400                              | 58  |
|                 | 28L-26/26      |                                                                                   |                                                                                   |                                                                                   |                                                                                    |                                                                                     | Front                                                                               | 300                                                                                 | 44  |                                                                                     |     | 420                              | 61  |
| <b>1210G</b>    | 600/55-26.5/20 | Front, Rear                                                                       | Front, Rear                                                                       |                                                                                   | Front, Rear<br>*Front, Rear                                                        |                                                                                     | *Front, Rear                                                                        | 400                                                                                 | 58  | 550                                                                                 | 80  | 550                              | 80  |
| <b>8 wheels</b> | 600/55R26.5    |                                                                                   |                                                                                   |                                                                                   |                                                                                    | Front, Rear                                                                         |                                                                                     | 400                                                                                 | 58  | 550                                                                                 | 80  | 550                              | 80  |
|                 | 710/45-26.5/20 | Front, Rear                                                                       | Front, Rear                                                                       |                                                                                   | Front, Rear<br>*Front, Rear                                                        |                                                                                     | *Front, Rear                                                                        | 400                                                                                 | 58  | 500                                                                                 | 73  | 550                              | 80  |







| Machine         | Tire size / PR | Tread pattern                                                                     |                                                                                   |                                                                                   |                                                                                    |                                                                                     |                                                                                     | Inflation pressure                                                                  |     |                                                                                     |     |                                  |     |     |    |     |    |
|-----------------|----------------|-----------------------------------------------------------------------------------|-----------------------------------------------------------------------------------|-----------------------------------------------------------------------------------|------------------------------------------------------------------------------------|-------------------------------------------------------------------------------------|-------------------------------------------------------------------------------------|-------------------------------------------------------------------------------------|-----|-------------------------------------------------------------------------------------|-----|----------------------------------|-----|-----|----|-----|----|
|                 |                |  |  |  |  |  |  |  |     |  |     | Max inflation and track pressure |     |     |    |     |    |
|                 |                | F2                                                                                | TRS 2                                                                             | TRS 2+                                                                            | F<br>*Nordman F                                                                    | Rider                                                                               | TRS<br>*Nordman TRS                                                                 | kPa                                                                                 | psi | kPa                                                                                 | psi | kPa                              | psi |     |    |     |    |
|                 | 710/45-26.5/24 | Front, Rear                                                                       |                                                                                   |                                                                                   | Front, Rear                                                                        |                                                                                     |                                                                                     |                                                                                     |     |                                                                                     |     | 400                              | 58  | 500 | 73 | 600 | 87 |
|                 | 710/45R26.5    |                                                                                   |                                                                                   |                                                                                   |                                                                                    | Front, Rear                                                                         |                                                                                     |                                                                                     |     |                                                                                     |     | 400                              | 58  | 500 | 73 | 550 | 80 |
|                 | 800/40-26.5/20 | Front, Rear                                                                       | Front, Rear                                                                       |                                                                                   | Front, Rear                                                                        |                                                                                     |                                                                                     |                                                                                     |     |                                                                                     |     | 400                              | 58  | 500 | 73 | 550 | 80 |
| <b>1210G</b>    | 600/55-26.5/20 | Rear                                                                              | Rear                                                                              |                                                                                   | Rear, *Rear                                                                        |                                                                                     |                                                                                     |                                                                                     |     |                                                                                     |     |                                  |     | 550 | 80 | 550 | 80 |
| <b>6 wheels</b> | 600/55R26.5    |                                                                                   |                                                                                   |                                                                                   |                                                                                    | Rear                                                                                |                                                                                     |                                                                                     |     |                                                                                     |     |                                  |     | 550 | 80 | 550 | 80 |
|                 | 710/45-26.5/20 | Rear                                                                              | Rear                                                                              |                                                                                   | Rear, *Rear                                                                        |                                                                                     |                                                                                     |                                                                                     |     |                                                                                     |     |                                  |     | 500 | 73 | 550 | 80 |
|                 | 710/45-26.5/24 | Rear                                                                              |                                                                                   |                                                                                   | Rear                                                                               |                                                                                     |                                                                                     |                                                                                     |     |                                                                                     |     |                                  |     | 500 | 73 | 600 | 87 |
|                 | 710/45R26.5    |                                                                                   |                                                                                   |                                                                                   |                                                                                    | Rear                                                                                |                                                                                     |                                                                                     |     |                                                                                     |     |                                  |     | 500 | 73 | 550 | 80 |
|                 | 800/40-26.5/20 | Rear                                                                              | Rear                                                                              |                                                                                   | Rear                                                                               |                                                                                     |                                                                                     |                                                                                     |     |                                                                                     |     |                                  |     | 500 | 73 | 550 | 80 |
|                 | 600/65-34/20   |                                                                                   |                                                                                   |                                                                                   |                                                                                    |                                                                                     |                                                                                     |                                                                                     |     |                                                                                     |     |                                  |     |     |    | 360 | 52 |
|                 | 600/65-34/24   |                                                                                   |                                                                                   | Front                                                                             |                                                                                    |                                                                                     |                                                                                     |                                                                                     |     |                                                                                     |     |                                  |     |     |    | 400 | 58 |
|                 | 600/65R34      |                                                                                   |                                                                                   |                                                                                   |                                                                                    | Front                                                                               |                                                                                     |                                                                                     |     |                                                                                     |     |                                  |     |     |    | 400 | 58 |
|                 | 700/55-34/20   |                                                                                   |                                                                                   |                                                                                   |                                                                                    |                                                                                     |                                                                                     |                                                                                     |     |                                                                                     |     |                                  |     |     |    | 360 | 52 |
|                 | 710/55-34/24   |                                                                                   |                                                                                   | Front                                                                             |                                                                                    |                                                                                     |                                                                                     |                                                                                     |     |                                                                                     |     |                                  |     |     |    | 400 | 58 |
|                 | 710/55R34      |                                                                                   |                                                                                   |                                                                                   |                                                                                    | Front                                                                               |                                                                                     |                                                                                     |     |                                                                                     |     |                                  |     |     |    | 400 | 58 |
|                 | 28L-26/26      |                                                                                   |                                                                                   |                                                                                   |                                                                                    |                                                                                     |                                                                                     |                                                                                     |     |                                                                                     |     |                                  |     |     |    | 420 | 61 |







| Machine         | Tire size / PR | Tread pattern                                                                     |                                                                                   |                                                                                   |                                                                                    |                                                                                     |                                                                                     | Inflation pressure                                                                  |     |                                                                                     |     |                                  |     |
|-----------------|----------------|-----------------------------------------------------------------------------------|-----------------------------------------------------------------------------------|-----------------------------------------------------------------------------------|------------------------------------------------------------------------------------|-------------------------------------------------------------------------------------|-------------------------------------------------------------------------------------|-------------------------------------------------------------------------------------|-----|-------------------------------------------------------------------------------------|-----|----------------------------------|-----|
|                 |                |  |  |  |  |  |  |  |     |  |     | Max inflation and track pressure |     |
|                 |                | F2                                                                                | TRS 2                                                                             | TRS 2+                                                                            | F<br>*Nordman F                                                                    | Rider                                                                               | TRS<br>*Nordman TRS                                                                 | kPa                                                                                 | psi | kPa                                                                                 | psi | kPa                              | psi |
| <b>1510G</b>    | 710/45-26.5/20 | Front, Rear                                                                       | Front, Rear                                                                       |                                                                                   | Front, Rear                                                                        |                                                                                     |                                                                                     |                                                                                     |     |                                                                                     |     |                                  |     |
| <b>8 wheels</b> | 710/45-26.5/24 | Front, Rear                                                                       |                                                                                   |                                                                                   | Front, Rear                                                                        |                                                                                     | 400                                                                                 | 58                                                                                  | 600 | 87                                                                                  | 600 | 87                               |     |
|                 | 710/45R26.5    |                                                                                   |                                                                                   |                                                                                   |                                                                                    | Front, Rear                                                                         | 400                                                                                 | 58                                                                                  | 550 | 80                                                                                  | 550 | 80                               |     |
|                 | 800/40-26.5/20 | Front, Rear                                                                       | Front, Rear                                                                       |                                                                                   | Front, Rear                                                                        |                                                                                     | 400                                                                                 | 58                                                                                  | 550 | 80                                                                                  | 550 | 80                               |     |
| <b>1510G</b>    | 710/45-26.5/20 | Rear                                                                              | Rear                                                                              |                                                                                   | Rear                                                                               |                                                                                     |                                                                                     |                                                                                     | 550 | 80                                                                                  | 550 | 80                               |     |
| <b>6 wheels</b> | 710/45-26.5/24 | Rear                                                                              |                                                                                   |                                                                                   | Rear                                                                               |                                                                                     |                                                                                     |                                                                                     | 600 | 87                                                                                  | 600 | 87                               |     |
|                 | 710/45R26.5    |                                                                                   |                                                                                   |                                                                                   |                                                                                    | Rear                                                                                |                                                                                     |                                                                                     | 550 | 80                                                                                  | 550 | 80                               |     |
|                 | 800/40-26.5/20 |                                                                                   | Rear                                                                              |                                                                                   | Rear                                                                               |                                                                                     |                                                                                     |                                                                                     | 500 | 73                                                                                  | 500 | 73                               |     |
|                 | 600/65-34/20   |                                                                                   |                                                                                   |                                                                                   |                                                                                    |                                                                                     | *Front                                                                              | 320                                                                                 | 46  |                                                                                     |     | 360                              | 52  |
|                 | 600/65-34/24   |                                                                                   |                                                                                   | Front                                                                             |                                                                                    |                                                                                     |                                                                                     | 320                                                                                 | 46  |                                                                                     |     | 400                              | 58  |
|                 | 600/65R34      |                                                                                   |                                                                                   |                                                                                   |                                                                                    | Front                                                                               |                                                                                     | 320                                                                                 | 46  |                                                                                     |     | 400                              | 58  |
|                 | 700/55-34/20   |                                                                                   |                                                                                   |                                                                                   |                                                                                    |                                                                                     | *Front                                                                              | 320                                                                                 | 46  |                                                                                     |     | 360                              | 52  |
|                 | 710/55-34/24   |                                                                                   |                                                                                   | Front                                                                             |                                                                                    |                                                                                     |                                                                                     | 320                                                                                 | 46  |                                                                                     |     | 400                              | 58  |
|                 | 710/55R34      |                                                                                   |                                                                                   |                                                                                   |                                                                                    | Front                                                                               |                                                                                     | 320                                                                                 | 46  |                                                                                     |     | 400                              | 58  |
| <b>1910G</b>    | 750/55-26.5/20 |                                                                                   |                                                                                   |                                                                                   | Front, Rear<br>*Front, Rear                                                        |                                                                                     |                                                                                     |                                                                                     |     | 550                                                                                 | 80  | 550                              | 80  |
| <b>8 wheels</b> | 750/55-26.5/24 | Front, Rear                                                                       | Front, Rear                                                                       |                                                                                   |                                                                                    |                                                                                     |                                                                                     | 450                                                                                 | 65  | 600                                                                                 | 87  | 600                              | 87  |

| Machine         | Tire size / PR | Tread pattern                                                                     |                                                                                   |                                                                                   |                                                                                    |                                                                                     |                                                                                     | Inflation pressure                                                                  |     |                                                                                     |     |                                  |     |
|-----------------|----------------|-----------------------------------------------------------------------------------|-----------------------------------------------------------------------------------|-----------------------------------------------------------------------------------|------------------------------------------------------------------------------------|-------------------------------------------------------------------------------------|-------------------------------------------------------------------------------------|-------------------------------------------------------------------------------------|-----|-------------------------------------------------------------------------------------|-----|----------------------------------|-----|
|                 |                |  |  |  |  |  |  |  |     |  |     | Max inflation and track pressure |     |
|                 |                | F2                                                                                | TRS 2                                                                             | TRS 2+                                                                            | F<br>*Nordman F                                                                    | Rider                                                                               | TRS<br>*Nordman TRS                                                                 | kPa                                                                                 | psi | kPa                                                                                 | psi | kPa                              | psi |
|                 | 780/55-26.5/20 |                                                                                   |                                                                                   |                                                                                   | Front, Rear                                                                        |                                                                                     |                                                                                     | 450                                                                                 | 65  | 600                                                                                 | 87  | 600                              | 87  |
|                 | 800/50R26.5    |                                                                                   |                                                                                   |                                                                                   |                                                                                    | Front, Rear                                                                         |                                                                                     | 450                                                                                 | 65  | 550                                                                                 | 80  | 550                              | 80  |
|                 | 710/55-28.5/24 | Front, Rear                                                                       | Front, Rear                                                                       |                                                                                   |                                                                                    |                                                                                     |                                                                                     | 500                                                                                 | 65  | 600                                                                                 | 87  | 600                              | 87  |
|                 | 780/50-28.5/24 | Front, Rear                                                                       | Front, Rear                                                                       |                                                                                   |                                                                                    |                                                                                     |                                                                                     | 450                                                                                 | 65  | 600                                                                                 | 87  | 600                              | 87  |
| <b>1910G</b>    | 750/55-26.5/20 |                                                                                   |                                                                                   |                                                                                   | Rear, *Rear                                                                        |                                                                                     |                                                                                     |                                                                                     |     | 550                                                                                 | 80  | 550                              | 80  |
| <b>6 wheels</b> | 750/55-26.5/24 | Rear                                                                              | Rear                                                                              |                                                                                   |                                                                                    |                                                                                     |                                                                                     |                                                                                     |     | 600                                                                                 | 87  | 600                              | 87  |
|                 | 780/55-26.5/20 |                                                                                   |                                                                                   |                                                                                   | Rear                                                                               |                                                                                     |                                                                                     |                                                                                     |     | 600                                                                                 | 87  | 600                              | 87  |
|                 | 800/50R26.5    |                                                                                   |                                                                                   |                                                                                   |                                                                                    | Rear                                                                                |                                                                                     |                                                                                     |     | 550                                                                                 | 80  | 550                              | 80  |
|                 | 710/55-28.5/24 | Rear                                                                              | Rear                                                                              |                                                                                   |                                                                                    |                                                                                     |                                                                                     |                                                                                     |     | 600                                                                                 | 87  | 600                              | 87  |
|                 | 780/50-28.5/24 | Rear                                                                              | Rear                                                                              |                                                                                   |                                                                                    |                                                                                     |                                                                                     |                                                                                     |     | 600                                                                                 | 87  | 600                              | 87  |
|                 | 700/70-34/20   |                                                                                   |                                                                                   |                                                                                   |                                                                                    |                                                                                     |                                                                                     | 340                                                                                 | 49  |                                                                                     |     | 360                              | 52  |
|                 | 710/70-34/24   |                                                                                   |                                                                                   | Front                                                                             |                                                                                    |                                                                                     |                                                                                     | 340                                                                                 | 49  |                                                                                     |     | 400                              | 58  |
|                 | 710/70R34      |                                                                                   |                                                                                   |                                                                                   |                                                                                    | Front                                                                               |                                                                                     | 340                                                                                 | 49  |                                                                                     |     | 400                              | 58  |







## LOGSET HARVESTERS







| Machine         | Tire size / PR | Tread pattern                                                                     |                                                                                   |                                                                                   |                                                                                   |                                                                                     |                                                                                     |                                                                                     | Inflation pressure |     |      |     |                                  |     |    |
|-----------------|----------------|-----------------------------------------------------------------------------------|-----------------------------------------------------------------------------------|-----------------------------------------------------------------------------------|-----------------------------------------------------------------------------------|-------------------------------------------------------------------------------------|-------------------------------------------------------------------------------------|-------------------------------------------------------------------------------------|--------------------|-----|------|-----|----------------------------------|-----|----|
|                 |                |  |  |  |  |  |  |  | Front              |     | Rear |     | Max inflation and track pressure |     |    |
|                 |                | F2                                                                                | F                                                                                 | Nordman F                                                                         | TRS 2                                                                             | Rider                                                                               | TRS                                                                                 | Nordman TRS                                                                         | kPa                | psi | kPa  | psi | kPa                              | psi |    |
| <b>4H</b>       | 650/60-26.5/12 |                                                                                   |                                                                                   |                                                                                   |                                                                                   |                                                                                     |                                                                                     | Front, Rear                                                                         |                    | 240 | 35   | 240 | 41                               | 280 | 41 |
| <b>4 wheels</b> | 750/55-26.5/20 |                                                                                   | Front, Rear                                                                       | Front, Rear                                                                       |                                                                                   |                                                                                     |                                                                                     | Front, Rear                                                                         | Front, Rear        | 280 | 41   | 280 | 41                               | 550 | 80 |
|                 | 750/55-26.5/24 | Front, Rear                                                                       |                                                                                   |                                                                                   | Front, Rear                                                                       |                                                                                     |                                                                                     |                                                                                     |                    | 280 | 41   | 280 | 41                               | 550 | 80 |
|                 | 780/55-26.5/20 |                                                                                   | Front, Rear                                                                       |                                                                                   |                                                                                   |                                                                                     |                                                                                     |                                                                                     |                    | 280 | 41   | 280 | 41                               | 550 | 80 |
|                 | 600/65-34/20   |                                                                                   |                                                                                   |                                                                                   |                                                                                   |                                                                                     |                                                                                     | Front, Rear                                                                         |                    | 280 | 41   | 280 | 41                               | 360 | 52 |
|                 | 600/65R34      |                                                                                   |                                                                                   |                                                                                   |                                                                                   | Front, Rear                                                                         |                                                                                     |                                                                                     |                    | 280 | 41   | 280 | 41                               | 400 | 58 |
|                 | 700/55-34/20   |                                                                                   |                                                                                   |                                                                                   |                                                                                   |                                                                                     |                                                                                     | Front, Rear                                                                         |                    | 260 | 38   | 280 | 41                               | 360 | 52 |
|                 | 710/55R34      |                                                                                   |                                                                                   |                                                                                   |                                                                                   | Front, Rear                                                                         |                                                                                     |                                                                                     |                    | 260 | 38   | 280 | 41                               | 400 | 58 |
| <b>5H</b>       | 600/50-22.5/20 |                                                                                   |                                                                                   |                                                                                   |                                                                                   |                                                                                     |                                                                                     | Front                                                                               |                    | 430 | 62   |     |                                  | 550 | 80 |
| <b>6 wheels</b> | 710/40-22.5/16 |                                                                                   | Front                                                                             |                                                                                   |                                                                                   |                                                                                     |                                                                                     |                                                                                     |                    | 400 | 58   |     |                                  | 430 | 62 |
|                 | 710/40-22.5/20 | Front                                                                             | Front                                                                             |                                                                                   |                                                                                   | Rear                                                                                |                                                                                     |                                                                                     |                    | 400 | 58   |     |                                  | 550 | 80 |
|                 | 600/65-34/20   |                                                                                   |                                                                                   |                                                                                   |                                                                                   |                                                                                     |                                                                                     | Rear                                                                                |                    |     |      | 280 | 41                               | 360 | 52 |
|                 | 600/65R34      |                                                                                   |                                                                                   |                                                                                   |                                                                                   | Rear                                                                                |                                                                                     |                                                                                     |                    |     |      | 280 | 41                               | 400 | 58 |
|                 | 700/55-34/20   |                                                                                   |                                                                                   |                                                                                   |                                                                                   |                                                                                     |                                                                                     | Rear                                                                                |                    |     |      | 280 | 41                               | 360 | 52 |
|                 | 710/55R34      |                                                                                   |                                                                                   |                                                                                   |                                                                                   | Rear                                                                                |                                                                                     |                                                                                     |                    |     |      | 280 | 41                               | 400 | 58 |
| <b>6H</b>       | 600/55-26.5/20 | Front                                                                             | Front                                                                             | Front                                                                             | Front                                                                             |                                                                                     |                                                                                     | Front                                                                               |                    | 550 | 80   |     |                                  | 550 | 80 |
| <b>6 wheels</b> | 600/55R26.5    |                                                                                   |                                                                                   |                                                                                   |                                                                                   |                                                                                     |                                                                                     | Front                                                                               |                    | 550 | 80   |     |                                  | 550 | 80 |
|                 | 710/45-26.5/20 | Front                                                                             | Front                                                                             | Front                                                                             | Front                                                                             |                                                                                     |                                                                                     | Front                                                                               |                    | 550 | 80   |     |                                  | 550 | 80 |
|                 | 710/45R26.5    |                                                                                   |                                                                                   |                                                                                   |                                                                                   | Front                                                                               |                                                                                     |                                                                                     |                    | 550 | 80   |     |                                  | 550 | 80 |

| Machine         | Tire size / PR | Tread pattern                                                                     |                                                                                   |                                                                                   |                                                                                   |                                                                                     |                                                                                     |                                                                                     | Inflation pressure |     |      |     |                                  |     |
|-----------------|----------------|-----------------------------------------------------------------------------------|-----------------------------------------------------------------------------------|-----------------------------------------------------------------------------------|-----------------------------------------------------------------------------------|-------------------------------------------------------------------------------------|-------------------------------------------------------------------------------------|-------------------------------------------------------------------------------------|--------------------|-----|------|-----|----------------------------------|-----|
|                 |                |  |  |  |  |  |  |  | Front              |     | Rear |     | Max inflation and track pressure |     |
|                 |                | F2                                                                                | F                                                                                 | Nordman F                                                                         | TRS 2                                                                             | Rider                                                                               | TRS                                                                                 | Nordman TRS                                                                         | kPa                | psi | kPa  | psi | kPa                              | psi |
|                 | 800/40-26.5/20 | Front                                                                             | Front                                                                             |                                                                                   | Front                                                                             |                                                                                     |                                                                                     |                                                                                     | 550                | 80  |      |     | 550                              | 80  |
|                 | 600/65-34/20   |                                                                                   |                                                                                   |                                                                                   |                                                                                   |                                                                                     |                                                                                     | Rear                                                                                |                    |     | 280  | 41  | 360                              | 52  |
|                 | 600/65R34      |                                                                                   |                                                                                   |                                                                                   |                                                                                   | Rear                                                                                |                                                                                     |                                                                                     |                    |     | 280  | 41  | 400                              | 58  |
|                 | 700/55-34/20   |                                                                                   |                                                                                   |                                                                                   |                                                                                   |                                                                                     |                                                                                     | Rear                                                                                |                    |     | 280  | 41  | 360                              | 52  |
|                 | 710/55R34      |                                                                                   |                                                                                   |                                                                                   |                                                                                   | Rear                                                                                |                                                                                     |                                                                                     |                    |     | 280  | 41  | 400                              | 58  |
| <b>8H</b>       | 600/55-26.5/20 | Front                                                                             | Front                                                                             | Front                                                                             | Front                                                                             |                                                                                     |                                                                                     | Front                                                                               | 550                | 80  |      |     | 550                              | 80  |
| <b>6 wheels</b> | 600/55R26.5    |                                                                                   |                                                                                   |                                                                                   |                                                                                   | Front                                                                               |                                                                                     |                                                                                     | 550                | 80  |      |     | 550                              | 80  |
|                 | 710/45-26.5/20 | Front                                                                             | Front                                                                             | Front                                                                             | Front                                                                             |                                                                                     |                                                                                     | Front                                                                               | 550                | 80  |      |     | 550                              | 80  |
|                 | 710/45R26.5    |                                                                                   |                                                                                   |                                                                                   |                                                                                   |                                                                                     |                                                                                     |                                                                                     | 550                | 80  |      |     | 550                              | 80  |
|                 | 800/40-26.5/20 | Front                                                                             | Front                                                                             |                                                                                   | Front                                                                             |                                                                                     |                                                                                     |                                                                                     | 550                | 80  |      |     | 550                              | 80  |
|                 | 600/65-34/20   |                                                                                   |                                                                                   |                                                                                   |                                                                                   |                                                                                     |                                                                                     | Rear                                                                                |                    |     | 280  | 41  | 360                              | 52  |
|                 | 600/65R34      |                                                                                   |                                                                                   |                                                                                   |                                                                                   | Rear                                                                                |                                                                                     |                                                                                     |                    |     | 280  | 41  | 400                              | 58  |
|                 | 700/55-34/20   |                                                                                   |                                                                                   |                                                                                   |                                                                                   |                                                                                     |                                                                                     | Rear                                                                                |                    |     | 280  | 41  | 360                              | 52  |
|                 | 710/55R34      |                                                                                   |                                                                                   |                                                                                   |                                                                                   | Rear                                                                                |                                                                                     |                                                                                     |                    |     | 280  | 41  | 400                              | 58  |
| <b>10H</b>      | 750/55-26.5/20 |                                                                                   | Front                                                                             | Front                                                                             |                                                                                   |                                                                                     | Front                                                                               | Front                                                                               | 500                | 73  |      |     | 550                              | 80  |
| <b>6 wheels</b> | 750/55-26.5/24 | Front                                                                             |                                                                                   |                                                                                   | Front                                                                             |                                                                                     |                                                                                     |                                                                                     | 500                | 73  |      |     | 550                              | 80  |
|                 | 780/55-26.5/20 |                                                                                   | Front                                                                             |                                                                                   |                                                                                   |                                                                                     |                                                                                     |                                                                                     | 500                | 73  |      |     | 550                              | 80  |
|                 | 710/55-28.5/24 | Front                                                                             |                                                                                   |                                                                                   | Front                                                                             |                                                                                     |                                                                                     |                                                                                     | 500                | 73  |      |     | 600                              | 87  |
|                 | 780/50-28.5/24 | Front                                                                             |                                                                                   |                                                                                   | Front                                                                             |                                                                                     |                                                                                     |                                                                                     | 500                | 73  |      |     | 600                              | 87  |
|                 | 700/70-34/16   |                                                                                   |                                                                                   |                                                                                   |                                                                                   |                                                                                     | Rear                                                                                |                                                                                     |                    |     | 260  | 38  | 260                              | 38  |







| Machine | Tire size / PR | Tread pattern                                                                     |                                                                                   |                                                                                   |                                                                                   |                                                                                     |                                                                                     |                                                                                     | Inflation pressure |     |      |     |                                  |     |
|---------|----------------|-----------------------------------------------------------------------------------|-----------------------------------------------------------------------------------|-----------------------------------------------------------------------------------|-----------------------------------------------------------------------------------|-------------------------------------------------------------------------------------|-------------------------------------------------------------------------------------|-------------------------------------------------------------------------------------|--------------------|-----|------|-----|----------------------------------|-----|
|         |                |  |  |  |  |  |  |  | Front              |     | Rear |     | Max inflation and track pressure |     |
|         |                | F2                                                                                | F                                                                                 | Nordman F                                                                         | TRS 2                                                                             | Rider                                                                               | TRS                                                                                 | Nordman TRS                                                                         | kPa                | psi | kPa  | psi | kPa                              | psi |
|         | 700/70-34/20   |                                                                                   |                                                                                   |                                                                                   |                                                                                   |                                                                                     |                                                                                     |                                                                                     |                    |     | 300  | 44  | 360                              | 52  |
|         | 710/70R34      |                                                                                   |                                                                                   |                                                                                   |                                                                                   | Rear                                                                                |                                                                                     |                                                                                     |                    |     | 300  | 44  | 400                              | 58  |

## LOGSET FORWARDERS







| Machine         | Tire size / PR | Tread pattern                                                                     |                                                                                   |                                                                                   |                                                                                    |                                                                                     |                                                                                     |                                                                                     | Inflation pressure |     |      |     |                                  |     |
|-----------------|----------------|-----------------------------------------------------------------------------------|-----------------------------------------------------------------------------------|-----------------------------------------------------------------------------------|------------------------------------------------------------------------------------|-------------------------------------------------------------------------------------|-------------------------------------------------------------------------------------|-------------------------------------------------------------------------------------|--------------------|-----|------|-----|----------------------------------|-----|
|                 |                |  |  |  |  |  |  |  | Front              |     | Rear |     | Max inflation and track pressure |     |
|                 |                | F2                                                                                | F                                                                                 | Nordman F                                                                         | TRS 2                                                                              | Rider                                                                               | TRS                                                                                 | Nordman TRS                                                                         | kPa                | psi | kPa  | psi | kPa                              | psi |
| <b>4F</b>       | 600/50-22.5/20 |                                                                                   |                                                                                   |                                                                                   |                                                                                    |                                                                                     |                                                                                     | Front, Rear                                                                         | 350                | 51  | 500  | 73  | 550                              | 80  |
| <b>8 wheels</b> | 710/40-22.5/16 |                                                                                   | Front, Rear                                                                       |                                                                                   |                                                                                    |                                                                                     |                                                                                     |                                                                                     | 350                | 51  | 430  | 62  | 430                              | 62  |
|                 | 710/40-22.5/20 | Front, Rear                                                                       |                                                                                   |                                                                                   | Front, Rear                                                                        |                                                                                     |                                                                                     |                                                                                     | 350                | 51  | 430  | 62  | 430                              | 62  |
| <b>5F</b>       | 600/55-26.5/20 | Front, Rear                                                                       | Front, Rear                                                                       | Front, Rear                                                                       | Front, Rear                                                                        |                                                                                     |                                                                                     | Front, Rear                                                                         | 350                | 51  | 550  | 80  | 550                              | 80  |
| <b>8 wheels</b> | 600/55R26.5    |                                                                                   |                                                                                   |                                                                                   |                                                                                    | Front, Rear                                                                         |                                                                                     |                                                                                     | 350                | 51  | 550  | 80  | 550                              | 80  |
|                 | 710/45-26.5/16 |                                                                                   | Front, Rear                                                                       |                                                                                   |                                                                                    |                                                                                     |                                                                                     |                                                                                     | 350                | 51  | 460  | 67  | 460                              | 67  |
|                 | 710/45-26.5/20 | Front, Rear                                                                       | Front, Rear                                                                       | Front, Rear                                                                       | Front, Rear                                                                        |                                                                                     |                                                                                     | Front, Rear                                                                         | 350                | 51  | 500  | 73  | 550                              | 80  |
|                 | 710/45R26.5    |                                                                                   |                                                                                   |                                                                                   |                                                                                    | Front, Rear                                                                         |                                                                                     |                                                                                     | 350                | 51  | 500  | 73  | 550                              | 80  |
|                 | 800/40-26.5/20 | Front, Rear                                                                       | Front, Rear                                                                       |                                                                                   | Front, Rear                                                                        |                                                                                     |                                                                                     |                                                                                     | 350                | 51  | 500  | 73  | 550                              | 80  |
| <b>6F</b>       | 600/55-26.5/20 | Front, Rear                                                                       | Front, Rear                                                                       | Front, Rear                                                                       | Front, Rear                                                                        |                                                                                     |                                                                                     | Front, Rear                                                                         | 350                | 51  | 550  | 80  | 550                              | 80  |
| <b>8 wheels</b> | 600/55R26.5    |                                                                                   |                                                                                   |                                                                                   |                                                                                    | Front, Rear                                                                         |                                                                                     |                                                                                     | 350                | 51  | 550  | 80  | 550                              | 80  |
|                 | 710/45-26.5/20 | Front, Rear                                                                       | Front, Rear                                                                       | Front, Rear                                                                       | Front, Rear                                                                        |                                                                                     |                                                                                     | Front, Rear                                                                         | 350                | 51  | 550  | 80  | 550                              | 80  |







| Machine               | Tire size / PR | Tread pattern                                                                     |                                                                                   |                                                                                   |                                                                                    |                                                                                     |                                                                                     |                                                                                     | Inflation pressure |     |      |     |                                  |     |
|-----------------------|----------------|-----------------------------------------------------------------------------------|-----------------------------------------------------------------------------------|-----------------------------------------------------------------------------------|------------------------------------------------------------------------------------|-------------------------------------------------------------------------------------|-------------------------------------------------------------------------------------|-------------------------------------------------------------------------------------|--------------------|-----|------|-----|----------------------------------|-----|
|                       |                |  |  |  |  |  |  |  | Front              |     | Rear |     | Max inflation and track pressure |     |
|                       |                | F2                                                                                | F                                                                                 | Nordman F                                                                         | TRS 2                                                                              | Rider                                                                               | TRS                                                                                 | Nordman TRS                                                                         | kPa                | psi | kPa  | psi | kPa                              | psi |
|                       | 710/45R26.5    |                                                                                   |                                                                                   |                                                                                   |                                                                                    | Front, Rear                                                                         |                                                                                     |                                                                                     | 350                | 51  | 550  | 80  | 550                              | 80  |
|                       | 800/40-26.5/20 | Front, Rear                                                                       | Front, Rear                                                                       |                                                                                   | Front, Rear                                                                        |                                                                                     |                                                                                     | 350                                                                                 | 51                 | 500 | 73   | 550 | 80                               |     |
| <b>8F</b>             | 710/45-26.5/20 | Front, Rear                                                                       | Front, Rear                                                                       | Front, Rear                                                                       | Front, Rear                                                                        |                                                                                     |                                                                                     | 400                                                                                 | 58                 | 550 | 80   | 550 | 80                               |     |
| <b>8 wheels</b>       | 710/45-26.5/24 | Front, Rear                                                                       |                                                                                   |                                                                                   |                                                                                    | Front, Rear                                                                         |                                                                                     | 400                                                                                 | 58                 | 550 | 80   | 600 | 87                               |     |
|                       | 710/45R26.5    |                                                                                   |                                                                                   |                                                                                   |                                                                                    | Front, Rear                                                                         |                                                                                     | 400                                                                                 | 58                 | 550 | 80   | 550 | 80                               |     |
|                       | 800/40-26.5/20 | Front, Rear                                                                       | Front, Rear                                                                       |                                                                                   | Front, Rear                                                                        |                                                                                     |                                                                                     | 400                                                                                 | 58                 | 500 | 73   | 550 | 80                               |     |
| <b>10F</b>            | 750/55-26.5/20 |                                                                                   | Front, Rear                                                                       | Front, Rear                                                                       |                                                                                    |                                                                                     | Front, Rear                                                                         | 400                                                                                 | 58                 | 550 | 80   | 550 | 80                               |     |
| <b>8 wheels</b>       | 750/55-26.5/24 | Front, Rear                                                                       |                                                                                   |                                                                                   | Front, Rear                                                                        |                                                                                     |                                                                                     | 400                                                                                 | 58                 | 550 | 80   | 600 | 87                               |     |
|                       | 780/55-26.5/20 |                                                                                   | Front, Rear                                                                       |                                                                                   |                                                                                    |                                                                                     |                                                                                     | 400                                                                                 | 58                 | 550 | 80   | 550 | 80                               |     |
|                       | 780/50-28.5/24 | Front, Rear                                                                       |                                                                                   |                                                                                   | Front, Rear                                                                        |                                                                                     |                                                                                     | 400                                                                                 | 58                 | 600 | 87   | 600 | 87                               |     |
| <b>12F - 8 wheels</b> | 780/50-28.5/24 | Front, Rear                                                                       |                                                                                   |                                                                                   | Front, Rear                                                                        |                                                                                     |                                                                                     | 450                                                                                 | 58                 | 600 | 87   | 600 | 87                               |     |

## PONSSE HARVESTERS

| Machine         | Tire size / PR | Tread pattern                                                                       |                                                                                     |                                                                                     |                                                                                      |                                                                                       |                                                                                       |                                                                                       | Inflation pressure |     |      |     |                                  |     |
|-----------------|----------------|-------------------------------------------------------------------------------------|-------------------------------------------------------------------------------------|-------------------------------------------------------------------------------------|--------------------------------------------------------------------------------------|---------------------------------------------------------------------------------------|---------------------------------------------------------------------------------------|---------------------------------------------------------------------------------------|--------------------|-----|------|-----|----------------------------------|-----|
|                 |                |  |  |  |  |  |  |  | Front              |     | Rear |     | Max inflation and track pressure |     |
|                 |                | F2                                                                                  | TRS 2                                                                               | TRS 2+                                                                              | *Nordman F                                                                           | Rider                                                                                 | ELS                                                                                   | *Nordman TRS                                                                          | kPa                | psi | kPa  | psi | kPa                              | psi |
| <b>Beaver</b>   | 600/55-26.5/20 | Front, Rear                                                                         | Front, Rear                                                                         |                                                                                     | Front, Rear<br>*Front, Rear                                                          |                                                                                       |                                                                                       | *Front, Rear                                                                          | 380                | 55  | 460  | 67  | 550                              | 80  |
| <b>6 wheels</b> | 600/55R26.5    |                                                                                     |                                                                                     |                                                                                     |                                                                                      | Front, Rear                                                                           |                                                                                       |                                                                                       | 380                | 55  | 460  | 67  | 550                              | 80  |

| Machine              | Tire size / PR | Tread pattern                                                                     |                                                                                   |                                                                                   |                                                                                    |                                                                                     |                                                                                     |                                                                                     | Inflation pressure |     |      |     |                                  |     |
|----------------------|----------------|-----------------------------------------------------------------------------------|-----------------------------------------------------------------------------------|-----------------------------------------------------------------------------------|------------------------------------------------------------------------------------|-------------------------------------------------------------------------------------|-------------------------------------------------------------------------------------|-------------------------------------------------------------------------------------|--------------------|-----|------|-----|----------------------------------|-----|
|                      |                |  |  |  |  |  |  |  | Front              |     | Rear |     | Max inflation and track pressure |     |
|                      |                | F2                                                                                | TRS 2                                                                             | TRS 2+                                                                            | F<br>*Nordman F                                                                    | Rider                                                                               | ELS                                                                                 | TRS<br>*Nordman TRS                                                                 | kPa                | psi | kPa  | psi | kPa                              | psi |
|                      | 710/45-26.5/16 |                                                                                   |                                                                                   |                                                                                   | Front, Rear                                                                        |                                                                                     |                                                                                     |                                                                                     | 350                | 51  | 460  | 67  | 460                              | 67  |
|                      | 710/45-26.5/20 | Front, Rear                                                                       | Front, Rear                                                                       |                                                                                   | Front, Rear<br>*Front, Rear                                                        |                                                                                     |                                                                                     | *Front, Rear                                                                        | 350                | 51  | 460  | 67  | 550                              | 80  |
|                      | 710/45R26.5    |                                                                                   |                                                                                   |                                                                                   |                                                                                    | Front, Rear                                                                         |                                                                                     |                                                                                     | 350                | 51  | 460  | 67  | 550                              | 80  |
|                      | 800/40-26.5/20 | Front, Rear                                                                       | Front, Rear                                                                       |                                                                                   | Front, Rear                                                                        |                                                                                     |                                                                                     |                                                                                     | 350                | 51  | 460  | 67  | 550                              | 80  |
|                      | 650/65-26.5/20 |                                                                                   |                                                                                   |                                                                                   |                                                                                    |                                                                                     | Front                                                                               | Front                                                                               | 350                | 51  | 460  | 67  | 550                              | 80  |
|                      | 750/55-26.5/20 | Front                                                                             | Front                                                                             |                                                                                   | Front                                                                              |                                                                                     |                                                                                     |                                                                                     | 350                | 51  | 460  | 67  | 550                              | 80  |
| <b>Fox</b>           | 600/55-26.5/20 | Front, Rear                                                                       | Front, Rear                                                                       |                                                                                   | Front, Rear<br>*Front, Rear                                                        |                                                                                     |                                                                                     | *Front, Rear                                                                        | 400                | 58  | 460  | 67  | 550                              | 80  |
| <b>8 wheels</b>      | 600/55R26.5    |                                                                                   |                                                                                   |                                                                                   |                                                                                    | Front, Rear                                                                         |                                                                                     |                                                                                     | 400                | 58  | 460  | 67  | 550                              | 80  |
|                      | 710/45-26.5/16 |                                                                                   |                                                                                   |                                                                                   | Front, Rear                                                                        |                                                                                     |                                                                                     |                                                                                     | 400                | 58  | 460  | 67  | 460                              | 67  |
|                      | 710/45-26.5/20 | Front, Rear                                                                       | Front, Rear                                                                       |                                                                                   | Front, Rear<br>*Front, Rear                                                        |                                                                                     |                                                                                     | *Front, Rear                                                                        | 400                | 58  | 460  | 67  | 550                              | 80  |
|                      | 710/45R26.5    |                                                                                   |                                                                                   |                                                                                   |                                                                                    | Front, Rear                                                                         |                                                                                     |                                                                                     | 400                | 58  | 460  | 67  | 550                              | 80  |
|                      | 800/40-26.5    | Front, Rear                                                                       | Front, Rear                                                                       |                                                                                   | Front, Rear                                                                        |                                                                                     |                                                                                     |                                                                                     | 400                | 58  | 460  | 67  | 550                              | 80  |
| <b>Scorpion</b>      | 600/55-26.5/20 | Front, Rear                                                                       | Front, Rear                                                                       |                                                                                   | Front, Rear<br>*Front, Rear                                                        |                                                                                     |                                                                                     | *Front, Rear                                                                        | 450                | 65  | 450  | 65  | 550                              | 80  |
| <b>Scorpion King</b> | 600/55R26.5    |                                                                                   |                                                                                   |                                                                                   |                                                                                    | Front, Rear                                                                         |                                                                                     |                                                                                     | 450                | 65  | 450  | 65  | 550                              | 80  |
| <b>8 wheels</b>      | 710/45-26.5/16 |                                                                                   |                                                                                   |                                                                                   | Front, Rear                                                                        |                                                                                     |                                                                                     |                                                                                     | 450                | 65  | 450  | 65  | 460                              | 67  |
|                      | 710/45-26.5/20 | Front, Rear                                                                       | Front, Rear                                                                       |                                                                                   | Front, Rear<br>*Front, Rear                                                        |                                                                                     |                                                                                     | *Front, Rear                                                                        | 450                | 65  | 450  | 65  | 550                              | 80  |
|                      | 710/45R26.5    |                                                                                   |                                                                                   |                                                                                   |                                                                                    | Front, Rear                                                                         |                                                                                     |                                                                                     | 450                | 65  | 450  | 65  | 550                              | 80  |

| Machine         | Tire size / PR | Tread pattern                                                                     |                                                                                   |                                                                                   |                                                                                    |                                                                                     |                                                                                     |                                                                                     | Inflation pressure |     |      |     |                                  |     |
|-----------------|----------------|-----------------------------------------------------------------------------------|-----------------------------------------------------------------------------------|-----------------------------------------------------------------------------------|------------------------------------------------------------------------------------|-------------------------------------------------------------------------------------|-------------------------------------------------------------------------------------|-------------------------------------------------------------------------------------|--------------------|-----|------|-----|----------------------------------|-----|
|                 |                |  |  |  |  |  |  |  | Front              |     | Rear |     | Max inflation and track pressure |     |
|                 |                | F2                                                                                | TRS 2                                                                             | TRS 2+                                                                            | F<br>*Nordman F                                                                    | Rider                                                                               | ELS                                                                                 | TRS<br>*Nordman TRS                                                                 | kPa                | psi | kPa  | psi | kPa                              | psi |
|                 | 800/40-26.5    | Front, Rear                                                                       | Front, Rear                                                                       |                                                                                   | Front, Rear                                                                        |                                                                                     |                                                                                     |                                                                                     | 450                | 65  | 450  | 65  | 550                              | 80  |
| <b>Cobra</b>    | 600/55-26.5/20 | Front, Rear                                                                       | Front, Rear                                                                       |                                                                                   | Front, Rear<br>*Front, Rear                                                        |                                                                                     |                                                                                     | *Front, Rear                                                                        | 350                | 51  | 460  | 67  | 550                              | 80  |
| <b>8 wheels</b> | 600/55R26.5    |                                                                                   |                                                                                   |                                                                                   |                                                                                    | Front, Rear                                                                         |                                                                                     |                                                                                     | 350                | 51  | 460  | 67  | 550                              | 80  |
|                 | 710/45-26.5/16 |                                                                                   |                                                                                   |                                                                                   | Front, Rear                                                                        |                                                                                     |                                                                                     |                                                                                     | 350                | 51  | 460  | 67  | 460                              | 67  |
|                 | 710/45-26.5/20 | Front, Rear                                                                       | Front, Rear                                                                       |                                                                                   | Front, Rear<br>*Front, Rear                                                        |                                                                                     |                                                                                     | *Front, Rear                                                                        | 350                | 51  | 460  | 67  | 550                              | 80  |
|                 | 710/45R26.5    |                                                                                   |                                                                                   |                                                                                   |                                                                                    | Front, Rear                                                                         |                                                                                     |                                                                                     | 350                | 51  | 460  | 67  | 550                              | 80  |
|                 | 800/40-26.5    | Front, Rear                                                                       | Front, Rear                                                                       |                                                                                   | Front, Rear                                                                        |                                                                                     |                                                                                     |                                                                                     | 350                | 51  | 460  | 67  | 550                              | 80  |
| <b>Ergo</b>     | 600/55-26.5/20 | Rear                                                                              |                                                                                   |                                                                                   | Rear, *Rear                                                                        |                                                                                     |                                                                                     | *Rear                                                                               |                    |     | 460  | 67  | 550                              | 80  |
| <b>6 wheels</b> | 600/55R26.5    |                                                                                   |                                                                                   |                                                                                   |                                                                                    | Rear                                                                                |                                                                                     |                                                                                     |                    |     | 460  | 67  | 550                              | 80  |
|                 | 710/45-26.5/16 |                                                                                   |                                                                                   |                                                                                   | Rear                                                                               |                                                                                     |                                                                                     |                                                                                     |                    |     | 460  | 67  | 460                              | 67  |
|                 | 710/45-26.5/20 | Rear                                                                              |                                                                                   |                                                                                   | Rear, *Rear                                                                        |                                                                                     |                                                                                     | *Rear                                                                               |                    |     | 460  | 67  | 550                              | 80  |
|                 | 710/45R26.5    |                                                                                   |                                                                                   |                                                                                   |                                                                                    | Rear                                                                                |                                                                                     |                                                                                     |                    |     | 460  | 67  | 550                              | 80  |
|                 | 800/40-26.5/20 | Rear                                                                              | Rear                                                                              |                                                                                   | Rear                                                                               |                                                                                     |                                                                                     |                                                                                     |                    |     | 460  | 67  | 550                              | 80  |
|                 | 600/65-34/20   |                                                                                   |                                                                                   |                                                                                   |                                                                                    |                                                                                     |                                                                                     | *Front                                                                              | 300                | 44  |      |     | 360                              | 52  |
|                 | 600/65-34/24   |                                                                                   |                                                                                   | Front                                                                             |                                                                                    |                                                                                     |                                                                                     |                                                                                     | 300                | 44  |      |     | 400                              | 58  |
|                 | 600/65R34      |                                                                                   |                                                                                   |                                                                                   |                                                                                    | Front                                                                               |                                                                                     |                                                                                     | 300                | 44  |      |     | 400                              | 58  |
|                 | 700/55-34/20   |                                                                                   |                                                                                   |                                                                                   |                                                                                    |                                                                                     |                                                                                     | *Front                                                                              | 300                | 44  |      |     | 360                              | 52  |
|                 | 710/55-34/24   |                                                                                   |                                                                                   | Front                                                                             |                                                                                    |                                                                                     |                                                                                     |                                                                                     | 300                | 44  |      |     | 400                              | 58  |
|                 | 710/55R34      |                                                                                   |                                                                                   |                                                                                   |                                                                                    | Front                                                                               |                                                                                     |                                                                                     | 300                | 44  |      |     | 400                              | 58  |

| Machine         | Tire size / PR | Tread pattern                                                                     |                                                                                   |                                                                                   |                                                                                    |                                                                                     |                                                                                     |                                                                                     | Inflation pressure |     |      |     |                                  |     |
|-----------------|----------------|-----------------------------------------------------------------------------------|-----------------------------------------------------------------------------------|-----------------------------------------------------------------------------------|------------------------------------------------------------------------------------|-------------------------------------------------------------------------------------|-------------------------------------------------------------------------------------|-------------------------------------------------------------------------------------|--------------------|-----|------|-----|----------------------------------|-----|
|                 |                |  |  |  |  |  |  |  | Front              |     | Rear |     | Max inflation and track pressure |     |
|                 |                | F2                                                                                | TRS 2                                                                             | TRS 2+                                                                            | F<br>*Nordman F                                                                    | Rider                                                                               | ELS                                                                                 | TRS<br>*Nordman TRS                                                                 | kPa                | psi | kPa  | psi | kPa                              | psi |
| <b>Ergo</b>     | 600/55-26.5/20 | Front, Rear                                                                       | Front, Rear                                                                       |                                                                                   | Front, Rear<br>*Front, Rear                                                        |                                                                                     |                                                                                     | *Front, Rear                                                                        | 350                | 51  | 460  | 67  | 550                              | 80  |
| <b>8 wheels</b> | 600/55R26.5    |                                                                                   |                                                                                   |                                                                                   |                                                                                    | Front, Rear                                                                         |                                                                                     |                                                                                     | 350                | 51  | 460  | 67  | 550                              | 80  |
|                 | 710/45-26.5/16 |                                                                                   |                                                                                   |                                                                                   | Front, Rear                                                                        |                                                                                     |                                                                                     |                                                                                     | 350                | 51  | 460  | 67  | 460                              | 67  |
|                 | 710/45-26.5/20 | Front, Rear                                                                       | Front, Rear                                                                       |                                                                                   | Front, Rear<br>*Front, Rear                                                        |                                                                                     |                                                                                     | *Front, Rear                                                                        | 350                | 51  | 460  | 67  | 550                              | 80  |
|                 | 710/45R26.5    |                                                                                   |                                                                                   |                                                                                   |                                                                                    | Front, Rear                                                                         |                                                                                     |                                                                                     | 350                | 51  | 460  | 67  | 550                              | 80  |
|                 | 800/40-26.5    | Front, Rear                                                                       | Front, Rear                                                                       |                                                                                   | Front, Rear                                                                        |                                                                                     |                                                                                     |                                                                                     | 350                | 51  | 460  | 67  | 550                              | 80  |
| <b>Bear</b>     | 650/65-26.5/20 |                                                                                   |                                                                                   |                                                                                   |                                                                                    |                                                                                     | Front, Rear                                                                         | Front, Rear                                                                         | 400                | 58  | 460  | 67  | 550                              | 80  |
| <b>8 wheels</b> | 750/55-26.5/20 |                                                                                   |                                                                                   |                                                                                   | Front, Rear<br>*Front, Rear                                                        |                                                                                     |                                                                                     | Front, Rear<br>*Front, Rear                                                         | 400                | 58  | 460  | 67  | 550                              | 80  |
|                 | 750/55-26.5/24 | Front, Rear                                                                       | Front, Rear                                                                       |                                                                                   |                                                                                    |                                                                                     |                                                                                     |                                                                                     | 400                | 58  | 460  | 67  | 600                              | 87  |
|                 | 780/55-26.5/20 |                                                                                   |                                                                                   |                                                                                   | Front, Rear                                                                        |                                                                                     |                                                                                     |                                                                                     | 400                | 58  | 460  | 67  | 550                              | 80  |
|                 | 800/50R26.5    |                                                                                   |                                                                                   |                                                                                   |                                                                                    | Front, Rear                                                                         |                                                                                     |                                                                                     | 400                | 58  | 460  | 67  | 550                              | 80  |
|                 | 710/55-28.5/24 | Front, Rear                                                                       | Front, Rear                                                                       |                                                                                   |                                                                                    |                                                                                     |                                                                                     |                                                                                     | 400                | 58  | 460  | 67  | 600                              | 87  |
|                 | 780/50-28.5/24 | Front, Rear                                                                       | Front, Rear                                                                       |                                                                                   |                                                                                    |                                                                                     |                                                                                     |                                                                                     | 400                | 58  | 460  | 67  | 600                              | 87  |
| <b>Bear</b>     | 650/65-26.5/20 |                                                                                   |                                                                                   |                                                                                   |                                                                                    |                                                                                     | Rear                                                                                | Rear                                                                                |                    |     | 460  | 67  | 550                              | 80  |
| <b>8 wheels</b> | 750/55-26.5/20 |                                                                                   |                                                                                   |                                                                                   | Rear, *Rear                                                                        |                                                                                     |                                                                                     | Rear, *Rear                                                                         |                    |     | 460  | 67  | 550                              | 80  |
|                 | 750/55-26.5/24 | Rear                                                                              | Rear                                                                              |                                                                                   |                                                                                    |                                                                                     |                                                                                     |                                                                                     |                    |     | 460  | 67  | 600                              | 87  |
|                 | 780/55-26.5/20 |                                                                                   |                                                                                   |                                                                                   | Rear                                                                               |                                                                                     |                                                                                     |                                                                                     |                    |     | 460  | 67  | 550                              | 80  |
|                 | 710/55-28.5/24 | Rear                                                                              | Rear                                                                              |                                                                                   |                                                                                    |                                                                                     |                                                                                     |                                                                                     |                    |     | 460  | 67  | 600                              | 87  |







| Machine | Tire size / PR | Tread pattern                                                                     |                                                                                   |                                                                                   |                                                                                    |                                                                                     |                                                                                     |                                                                                     | Inflation pressure |     |      |     |                                  |     |
|---------|----------------|-----------------------------------------------------------------------------------|-----------------------------------------------------------------------------------|-----------------------------------------------------------------------------------|------------------------------------------------------------------------------------|-------------------------------------------------------------------------------------|-------------------------------------------------------------------------------------|-------------------------------------------------------------------------------------|--------------------|-----|------|-----|----------------------------------|-----|
|         |                |  |  |  |  |  |  |  | Front              |     | Rear |     | Max inflation and track pressure |     |
|         |                | F2                                                                                | TRS 2                                                                             | TRS 2+                                                                            | F<br>*Nordman F                                                                    | Rider                                                                               | ELS                                                                                 | TRS<br>*Nordman TRS                                                                 | kPa                | psi | kPa  | psi | kPa                              | psi |
|         | 780/50-28.5/24 | Rear                                                                              | Rear                                                                              |                                                                                   |                                                                                    |                                                                                     |                                                                                     |                                                                                     |                    |     | 460  | 67  | 600                              | 87  |
|         | 800/50R26.5    |                                                                                   |                                                                                   |                                                                                   |                                                                                    | Rear                                                                                |                                                                                     |                                                                                     |                    |     | 460  | 67  | 550                              | 80  |
|         | 700/70-34/16   |                                                                                   |                                                                                   |                                                                                   |                                                                                    |                                                                                     | Front                                                                               | 260                                                                                 | 38                 |     |      |     | 260                              | 38  |
|         | 700/70-34/20   |                                                                                   |                                                                                   |                                                                                   |                                                                                    |                                                                                     | Front                                                                               | 300                                                                                 | 44                 |     |      |     | 360                              | 52  |
|         | 710/70-34/24   |                                                                                   |                                                                                   | Front                                                                             |                                                                                    |                                                                                     |                                                                                     | 300                                                                                 | 44                 |     |      |     | 400                              | 58  |
|         | 710/70R34      |                                                                                   |                                                                                   |                                                                                   |                                                                                    | Front                                                                               |                                                                                     | 300                                                                                 | 44                 |     |      |     | 400                              | 58  |

## PONSSE FORWARDERS





| Machine              | Tire size / PR | Tread pattern                                                                     |                                                                                   |                                                                                   |                                                                                     |                                                                                     |                                                                                     | Inflation pressure |     |      |     |                                  |     |
|----------------------|----------------|-----------------------------------------------------------------------------------|-----------------------------------------------------------------------------------|-----------------------------------------------------------------------------------|-------------------------------------------------------------------------------------|-------------------------------------------------------------------------------------|-------------------------------------------------------------------------------------|--------------------|-----|------|-----|----------------------------------|-----|
|                      |                |  |  |  |  |  |  | Front              |     | Rear |     | Max inflation and track pressure |     |
|                      |                | F2                                                                                | TRS 2                                                                             | TRS 2+                                                                            | F<br>*Nordman F                                                                     | Rider                                                                               | TRS<br>*Nordman TRS                                                                 | kPa                | psi | kPa  | psi | kPa                              | psi |
| <b>Gazelle</b>       | 600/50-22.5/20 | Front, Rear                                                                       | Front, Rear                                                                       |                                                                                   |                                                                                     |                                                                                     | Front, Rear                                                                         | 350                | 51  | 500  | 73  | 550                              | 80  |
| <b>8 wheels</b>      | 710/40-22.5/16 |                                                                                   |                                                                                   |                                                                                   | Front, Rear                                                                         |                                                                                     | Front, Rear                                                                         | 350                | 51  | 430  | 62  | 430                              | 62  |
|                      | 710/40-22.5/20 | Front, Rear                                                                       | Front, Rear                                                                       |                                                                                   |                                                                                     |                                                                                     |                                                                                     | 350                | 51  | 430  | 62  | 550                              | 80  |
| <b>Wisent / Dual</b> | 600/55-26.5/20 | Front, Rear                                                                       | Front, Rear                                                                       |                                                                                   | Front, Rear<br>*Front, Rear                                                         |                                                                                     | *Front, Rear                                                                        | 350                | 51  | 550  | 80  | 550                              | 80  |
| <b>8 wheels</b>      | 600/55R26.5    |                                                                                   |                                                                                   |                                                                                   |                                                                                     | Front, Rear                                                                         |                                                                                     | 350                | 51  | 550  | 80  | 550                              | 80  |
|                      | 710/45-26.5/16 |                                                                                   |                                                                                   |                                                                                   | Front, Rear                                                                         |                                                                                     |                                                                                     | 350                | 51  | 460  | 67  | 460                              | 67  |

| Machine              | Tire size / PR | Tread pattern                                                                     |                                                                                   |                                                                                   |                                                                                     |                                                                                     |                                                                                     | Inflation pressure |     |      |     |                                  |     |
|----------------------|----------------|-----------------------------------------------------------------------------------|-----------------------------------------------------------------------------------|-----------------------------------------------------------------------------------|-------------------------------------------------------------------------------------|-------------------------------------------------------------------------------------|-------------------------------------------------------------------------------------|--------------------|-----|------|-----|----------------------------------|-----|
|                      |                |  |  |  |  |  |  | Front              |     | Rear |     | Max inflation and track pressure |     |
|                      |                | F2                                                                                | TRS 2                                                                             | TRS 2+                                                                            | F<br>*Nordman F                                                                     | Rider                                                                               | TRS<br>*Nordman TRS                                                                 | kPa                | psi | kPa  | psi | kPa                              | psi |
|                      | 710/45-26.5/20 | Front, Rear                                                                       | Front, Rear                                                                       |                                                                                   | Front, Rear<br>*Front, Rear                                                         |                                                                                     | *Front, Rear                                                                        | 350                | 51  | 500  | 73  | 550                              | 80  |
|                      | 710/45R26.5    |                                                                                   |                                                                                   |                                                                                   |                                                                                     | Front, Rear                                                                         |                                                                                     | 350                | 51  | 500  | 73  | 550                              | 80  |
|                      | 800/40-26.5/20 | Front, Rear                                                                       | Front, Rear                                                                       |                                                                                   | Front, Rear                                                                         |                                                                                     |                                                                                     | 350                | 51  | 500  | 73  | 500                              | 73  |
| <b>Wisent / Dual</b> | 600/55-26.5/20 | Rear                                                                              | Rear                                                                              |                                                                                   | Rear, *Rear                                                                         |                                                                                     | *Rear                                                                               |                    |     | 550  | 80  | 550                              | 80  |
| <b>6 wheels</b>      | 600/55R26.5    |                                                                                   |                                                                                   |                                                                                   |                                                                                     | Rear                                                                                |                                                                                     |                    |     | 550  | 80  | 550                              | 80  |
|                      | 710/45-26.5/16 |                                                                                   |                                                                                   |                                                                                   | Rear                                                                                |                                                                                     |                                                                                     |                    |     | 460  | 67  | 460                              | 67  |
|                      | 710/45-26.5/20 | Rear                                                                              | Rear                                                                              |                                                                                   | Rear, *Rear                                                                         |                                                                                     | *Rear                                                                               |                    |     | 500  | 73  | 550                              | 80  |
|                      | 710/45R26.5    |                                                                                   |                                                                                   |                                                                                   |                                                                                     | Rear                                                                                |                                                                                     |                    |     | 500  | 73  | 550                              | 80  |
|                      | 800/40-26.5/20 | Rear                                                                              | Rear                                                                              |                                                                                   | Rear                                                                                |                                                                                     |                                                                                     |                    |     | 500  | 73  | 550                              | 80  |
|                      | 600/65-34/20   |                                                                                   |                                                                                   |                                                                                   |                                                                                     |                                                                                     | *Front                                                                              | 300                | 44  |      |     | 360                              | 52  |
|                      | 600/65-34/24   |                                                                                   |                                                                                   | Front                                                                             |                                                                                     |                                                                                     |                                                                                     | 300                | 44  |      |     | 400                              | 58  |
|                      | 600/65R34      |                                                                                   |                                                                                   |                                                                                   |                                                                                     | Front                                                                               |                                                                                     | 300                | 44  |      |     | 400                              | 58  |
|                      | 700/55-34/20   |                                                                                   |                                                                                   |                                                                                   |                                                                                     |                                                                                     | *Front                                                                              | 300                | 44  |      |     | 360                              | 52  |
|                      | 710/55-34/24   |                                                                                   |                                                                                   | Front                                                                             |                                                                                     |                                                                                     |                                                                                     | 300                | 44  |      |     | 400                              | 58  |
|                      | 710/55R34      |                                                                                   |                                                                                   |                                                                                   |                                                                                     | Front                                                                               |                                                                                     | 300                | 44  |      |     | 400                              | 58  |
| <b>Elk</b>           | 600/55-26.5/20 | Front, Rear                                                                       | Front, Rear                                                                       |                                                                                   | Front, Rear<br>*Front, Rear                                                         |                                                                                     | *Front, Rear                                                                        | 350                | 51  | 550  | 80  | 550                              | 80  |
| <b>8 wheels</b>      | 600/55R26.5    |                                                                                   |                                                                                   |                                                                                   |                                                                                     | Front, Rear                                                                         |                                                                                     | 350                | 51  | 550  | 80  | 550                              | 80  |
|                      | 710/45-26.5/20 | Front, Rear                                                                       | Front, Rear                                                                       |                                                                                   | Front, Rear<br>*Front, Rear                                                         |                                                                                     | *Front, Rear                                                                        | 350                | 51  | 500  | 73  | 550                              | 80  |







| Machine         | Tire size / PR | Tread pattern                                                                     |                                                                                   |                                                                                   |                                                                                     |                                                                                     |                                                                                     | Inflation pressure |     |      |     |                                  |     |
|-----------------|----------------|-----------------------------------------------------------------------------------|-----------------------------------------------------------------------------------|-----------------------------------------------------------------------------------|-------------------------------------------------------------------------------------|-------------------------------------------------------------------------------------|-------------------------------------------------------------------------------------|--------------------|-----|------|-----|----------------------------------|-----|
|                 |                |  |  |  |  |  |  | Front              |     | Rear |     | Max inflation and track pressure |     |
|                 |                | F2                                                                                | TRS 2                                                                             | TRS 2+                                                                            | F<br>*Nordman F                                                                     | Rider                                                                               | TRS<br>*Nordman TRS                                                                 | kPa                | psi | kPa  | psi | kPa                              | psi |
|                 | 710/45-26.5/24 | Front, Rear                                                                       |                                                                                   |                                                                                   | Front, Rear                                                                         |                                                                                     |                                                                                     | 350                | 51  | 500  | 73  | 600                              | 87  |
|                 | 710/45R26.5    |                                                                                   |                                                                                   |                                                                                   |                                                                                     | Front, Rear                                                                         |                                                                                     | 350                | 51  | 500  | 73  | 550                              | 80  |
|                 | 800/40-26.5/20 | Front, Rear                                                                       | Front, Rear                                                                       |                                                                                   | Front, Rear                                                                         |                                                                                     |                                                                                     | 350                | 51  | 500  | 73  | 550                              | 80  |
| <b>Elk</b>      | 600/55-26.5/20 | Rear                                                                              | Rear                                                                              |                                                                                   | Rear, *Rear                                                                         |                                                                                     | *Rear                                                                               |                    |     | 550  | 80  | 550                              | 80  |
| <b>6 wheels</b> | 600/55R26.5    |                                                                                   |                                                                                   |                                                                                   |                                                                                     | Rear                                                                                |                                                                                     |                    |     | 550  | 80  | 550                              | 80  |
|                 | 710/45-26.5/20 | Rear                                                                              | Rear                                                                              |                                                                                   | Rear, *Rear                                                                         |                                                                                     | *Rear                                                                               |                    |     | 500  | 73  | 550                              | 80  |
|                 | 710/45-26.5/24 | Rear                                                                              |                                                                                   |                                                                                   | Rear                                                                                |                                                                                     |                                                                                     |                    |     | 500  | 73  | 600                              | 87  |
|                 | 710/45R26.5    |                                                                                   |                                                                                   |                                                                                   |                                                                                     | Rear                                                                                |                                                                                     |                    |     | 500  | 73  | 550                              | 80  |
|                 | 800/40-26.5/20 | Rear                                                                              | Rear                                                                              |                                                                                   | Rear                                                                                |                                                                                     |                                                                                     |                    |     | 500  | 73  | 550                              | 80  |
|                 | 600/65-34/20   |                                                                                   |                                                                                   |                                                                                   |                                                                                     |                                                                                     | *Front                                                                              | 320                | 46  |      |     | 360                              | 52  |
|                 | 600/65-34/24   |                                                                                   |                                                                                   | Front                                                                             |                                                                                     |                                                                                     |                                                                                     | 320                | 46  |      |     | 400                              | 58  |
|                 | 600/65R34      |                                                                                   |                                                                                   |                                                                                   |                                                                                     | Front                                                                               |                                                                                     | 320                | 46  |      |     | 400                              | 58  |
|                 | 700/55-34/20   |                                                                                   |                                                                                   |                                                                                   |                                                                                     |                                                                                     | *Front                                                                              | 320                | 46  |      |     | 360                              | 52  |
|                 | 710/55-34/24   |                                                                                   |                                                                                   | Front                                                                             |                                                                                     |                                                                                     |                                                                                     | 320                | 46  |      |     | 400                              | 58  |
|                 | 710/55R34      |                                                                                   |                                                                                   |                                                                                   |                                                                                     | Front                                                                               |                                                                                     | 320                | 46  |      |     | 400                              | 58  |
| <b>Bison</b>    | 710/45-26.5/20 | Front, Rear                                                                       | Front, Rear                                                                       |                                                                                   | Front, Rear<br>*Front, Rear                                                         |                                                                                     | *Front, Rear                                                                        | 400                | 58  | 550  | 80  | 550                              | 80  |
| <b>8 wheels</b> | 710/45-26.5/24 | Front, Rear                                                                       | Front, Rear                                                                       |                                                                                   | Front, Rear                                                                         |                                                                                     |                                                                                     | 400                | 58  | 550  | 80  | 600                              | 87  |
|                 | 710/45R26.5    |                                                                                   |                                                                                   |                                                                                   |                                                                                     | Front, Rear                                                                         |                                                                                     | 400                | 58  | 550  | 80  | 550                              | 80  |
|                 | 800/40-26.5/20 | Front, Rear                                                                       | Front, Rear                                                                       |                                                                                   | Front, Rear                                                                         |                                                                                     |                                                                                     | 400                | 58  | 550  | 80  | 550                              | 80  |

| Machine                     | Tire size / PR | Tread pattern                                                                     |                                                                                   |                                                                                   |                                                                                     |                                                                                     |                                                                                     | Inflation pressure |     |      |     |                                  |     |
|-----------------------------|----------------|-----------------------------------------------------------------------------------|-----------------------------------------------------------------------------------|-----------------------------------------------------------------------------------|-------------------------------------------------------------------------------------|-------------------------------------------------------------------------------------|-------------------------------------------------------------------------------------|--------------------|-----|------|-----|----------------------------------|-----|
|                             |                |  |  |  |  |  |  | Front              |     | Rear |     | Max inflation and track pressure |     |
|                             |                | F2                                                                                | TRS 2                                                                             | TRS 2+                                                                            | F<br>*Nordman F                                                                     | Rider                                                                               | TRS<br>*Nordman TRS                                                                 | kPa                | psi | kPa  | psi | kPa                              | psi |
| <b>Buffalo / Dual</b>       | 710/45-26.5/20 | Front, Rear                                                                       | Front, Rear                                                                       |                                                                                   | Front, Rear<br>*Front, Rear                                                         |                                                                                     | *Front, Rear                                                                        | 400                | 58  | 550  | 80  | 550                              | 80  |
| <b>8 wheels</b>             | 710/45-26.5/24 | Front, Rear                                                                       | Front, Rear                                                                       |                                                                                   | Front, Rear                                                                         |                                                                                     |                                                                                     | 400                | 58  | 550  | 80  | 600                              | 87  |
|                             | 710/45R26.5    |                                                                                   |                                                                                   |                                                                                   |                                                                                     | Front, Rear                                                                         |                                                                                     | 400                | 58  | 550  | 80  | 550                              | 80  |
|                             | 800/40-26.5/20 | Front, Rear                                                                       | Front, Rear                                                                       |                                                                                   | Front, Rear                                                                         |                                                                                     |                                                                                     | 400                | 58  | 550  | 80  | 550                              | 80  |
| <b>Buffalo / Dual / ADS</b> | 710/45-26.5/20 | Rear                                                                              | Rear                                                                              |                                                                                   | Rear, *Rear                                                                         |                                                                                     | *Rear                                                                               |                    |     | 550  | 80  | 550                              | 80  |
| <b>6 wheels</b>             | 710/45-26.5/24 | Rear                                                                              | Rear                                                                              |                                                                                   | Rear                                                                                |                                                                                     |                                                                                     |                    |     | 550  | 80  | 600                              | 87  |
|                             | 710/45R26.5    |                                                                                   |                                                                                   |                                                                                   |                                                                                     | Rear                                                                                |                                                                                     |                    |     | 550  | 80  | 550                              | 80  |
|                             | 800/40-26.5/20 | Rear                                                                              | Rear                                                                              |                                                                                   | Rear                                                                                |                                                                                     |                                                                                     |                    |     | 550  | 80  | 550                              | 80  |
|                             | 600/65-34/20   |                                                                                   |                                                                                   |                                                                                   |                                                                                     |                                                                                     | *Front                                                                              | 320                | 46  |      |     | 360                              | 52  |
|                             | 600/65-34/24   |                                                                                   |                                                                                   | Front                                                                             |                                                                                     |                                                                                     |                                                                                     | 320                | 46  |      |     | 400                              | 58  |
|                             | 600/65R34      |                                                                                   |                                                                                   |                                                                                   |                                                                                     | Front                                                                               |                                                                                     | 320                | 46  |      |     | 400                              | 58  |
|                             | 700/55-34/20   |                                                                                   |                                                                                   |                                                                                   |                                                                                     |                                                                                     | *Front                                                                              | 320                | 46  |      |     | 360                              | 52  |
|                             | 710/55-34/24   |                                                                                   |                                                                                   | Front                                                                             |                                                                                     |                                                                                     |                                                                                     | 320                | 46  |      |     | 400                              | 58  |
|                             | 710/55R34      |                                                                                   |                                                                                   |                                                                                   |                                                                                     | Front                                                                               |                                                                                     | 320                | 46  |      |     | 400                              | 58  |
| <b>Buffalo King</b>         | 600/55-26.5/20 | Front                                                                             | Front                                                                             |                                                                                   | Front, *Front                                                                       |                                                                                     | *Front                                                                              | 400                | 58  |      |     | 550                              | 80  |
| <b>8 wheels</b>             | 600/55R26.5    |                                                                                   |                                                                                   |                                                                                   |                                                                                     | Front                                                                               |                                                                                     | 400                | 58  |      |     | 550                              | 80  |
|                             | 710/45-26.5/20 | Front                                                                             | Front                                                                             |                                                                                   | Front, *Front                                                                       |                                                                                     | *Front                                                                              | 400                | 58  |      |     | 550                              | 80  |
|                             | 710/45-26.5/24 | Front                                                                             | Front                                                                             |                                                                                   | Front                                                                               |                                                                                     |                                                                                     | 400                | 58  |      |     | 600                              | 87  |
|                             | 710/45R26.5    |                                                                                   |                                                                                   |                                                                                   |                                                                                     | Front                                                                               |                                                                                     | 400                | 58  |      |     | 550                              | 80  |





| Machine             | Tire size / PR | Tread pattern                                                                     |                                                                                   |                                                                                   |                                                                                     |                                                                                     |                                                                                     | Inflation pressure |     |      |     |                                  |     |
|---------------------|----------------|-----------------------------------------------------------------------------------|-----------------------------------------------------------------------------------|-----------------------------------------------------------------------------------|-------------------------------------------------------------------------------------|-------------------------------------------------------------------------------------|-------------------------------------------------------------------------------------|--------------------|-----|------|-----|----------------------------------|-----|
|                     |                |  |  |  |  |  |  | Front              |     | Rear |     | Max inflation and track pressure |     |
|                     |                | F2                                                                                | TRS 2                                                                             | TRS 2+                                                                            | F<br>*Nordman F                                                                     | Rider                                                                               | TRS<br>*Nordman TRS                                                                 | kPa                | psi | kPa  | psi | kPa                              | psi |
|                     | 800/40-26.5/20 | Front                                                                             | Front                                                                             |                                                                                   | Front                                                                               |                                                                                     |                                                                                     | 400                | 58  |      |     | 550                              | 80  |
|                     | 750/55-26.5/20 |                                                                                   |                                                                                   |                                                                                   | Rear, *Rear                                                                         |                                                                                     |                                                                                     |                    |     | 550  | 80  | 550                              | 80  |
|                     | 750/55-26.5/24 | Rear                                                                              | Rear                                                                              |                                                                                   |                                                                                     |                                                                                     |                                                                                     |                    |     | 550  | 80  | 600                              | 87  |
|                     | 780/55-26.5/20 |                                                                                   |                                                                                   |                                                                                   | Rear                                                                                |                                                                                     |                                                                                     |                    |     | 550  | 80  | 550                              | 80  |
|                     | 800/50R26.5    |                                                                                   |                                                                                   |                                                                                   |                                                                                     | Rear                                                                                |                                                                                     |                    |     | 550  | 80  | 550                              | 80  |
| <b>Buffalo King</b> | 750/55-26.5/20 |                                                                                   |                                                                                   |                                                                                   | Rear, *Rear                                                                         |                                                                                     |                                                                                     |                    |     | 500  | 73  | 550                              | 80  |
| <b>6 wheels</b>     | 750/55-26.5/24 | Rear                                                                              | Rear                                                                              |                                                                                   |                                                                                     |                                                                                     |                                                                                     |                    |     | 500  | 73  | 600                              | 87  |
|                     | 780/55-26.5/20 |                                                                                   |                                                                                   |                                                                                   | Rear                                                                                |                                                                                     |                                                                                     |                    |     | 500  | 73  | 550                              | 80  |
|                     | 800/50R26.5    |                                                                                   |                                                                                   |                                                                                   |                                                                                     | Rear                                                                                |                                                                                     |                    |     | 500  | 73  | 550                              | 80  |
|                     | 700/70-34/16   |                                                                                   |                                                                                   |                                                                                   |                                                                                     |                                                                                     | Front                                                                               | 260                | 38  |      |     | 260                              | 38  |
|                     | 700/70-34/20   |                                                                                   |                                                                                   |                                                                                   |                                                                                     |                                                                                     | *Front                                                                              | 300                | 44  |      |     | 360                              | 52  |
|                     | 710/70-34/24   |                                                                                   |                                                                                   | Front                                                                             |                                                                                     |                                                                                     |                                                                                     | 300                | 44  |      |     | 400                              | 58  |
|                     | 710/70R34      |                                                                                   |                                                                                   |                                                                                   |                                                                                     | Front                                                                               |                                                                                     | 300                | 44  |      |     | 400                              | 58  |
| <b>Elephant</b>     | 750/55-26.5/20 |                                                                                   |                                                                                   |                                                                                   | Front, Rear<br>*Front, Rear                                                         |                                                                                     | Front, Rear<br>*Front, Rear                                                         | 450                | 65  | 550  | 80  | 550                              | 80  |
| <b>8 wheels</b>     | 750/55-26.5/24 | Front, Rear                                                                       | Front, Rear                                                                       |                                                                                   |                                                                                     |                                                                                     |                                                                                     | 450                | 65  | 600  | 87  | 600                              | 87  |
|                     | 780/55-26.5/20 |                                                                                   |                                                                                   |                                                                                   | Front, Rear                                                                         |                                                                                     |                                                                                     | 450                | 65  | 550  | 80  | 550                              | 80  |
|                     | 780/50-28.5/24 | Front, Rear                                                                       | Front, Rear                                                                       |                                                                                   |                                                                                     |                                                                                     |                                                                                     | 450                | 65  | 600  | 87  | 600                              | 87  |
|                     | 800/50R26.5    |                                                                                   |                                                                                   |                                                                                   |                                                                                     | Front, Rear                                                                         |                                                                                     | 450                | 65  | 550  | 80  | 550                              | 80  |
| <b>Elephant</b>     | 750/55-26.5/20 |                                                                                   |                                                                                   |                                                                                   | Rear, *Rear                                                                         |                                                                                     | Rear, *Rear                                                                         |                    |     | 550  | 80  | 550                              | 80  |

| Machine              | Tire size / PR | Tread pattern                                                                     |                                                                                   |                                                                                   |                                                                                     |                                                                                     |                                                                                     | Inflation pressure |     |      |     |                                  |     |
|----------------------|----------------|-----------------------------------------------------------------------------------|-----------------------------------------------------------------------------------|-----------------------------------------------------------------------------------|-------------------------------------------------------------------------------------|-------------------------------------------------------------------------------------|-------------------------------------------------------------------------------------|--------------------|-----|------|-----|----------------------------------|-----|
|                      |                |  |  |  |  |  |  | Front              |     | Rear |     | Max inflation and track pressure |     |
|                      |                | F2                                                                                | TRS 2                                                                             | TRS 2+                                                                            | F<br>*Nordman F                                                                     | Rider                                                                               | TRS<br>*Nordman TRS                                                                 | kPa                | psi | kPa  | psi | kPa                              | psi |
| <b>6 wheels</b>      | 750/55-26.5/24 | Rear                                                                              | Rear                                                                              |                                                                                   |                                                                                     |                                                                                     |                                                                                     |                    |     | 600  | 87  | 600                              | 87  |
|                      | 780/55-26.5/20 |                                                                                   |                                                                                   |                                                                                   | Rear                                                                                |                                                                                     |                                                                                     |                    |     | 550  | 80  | 550                              | 80  |
|                      | 800/50R26.5    |                                                                                   |                                                                                   |                                                                                   |                                                                                     | Rear                                                                                |                                                                                     |                    |     | 550  | 80  | 550                              | 80  |
|                      | 780/50-28.5/24 | Rear                                                                              | Rear                                                                              |                                                                                   |                                                                                     |                                                                                     |                                                                                     |                    |     | 600  | 87  | 600                              | 87  |
|                      | 700/70-34/16   |                                                                                   |                                                                                   |                                                                                   |                                                                                     |                                                                                     | Front                                                                               | 260                | 38  |      |     | 260                              | 38  |
|                      | 700/70-34/20   |                                                                                   |                                                                                   |                                                                                   |                                                                                     |                                                                                     | *Front                                                                              | 320                | 46  |      |     | 360                              | 52  |
|                      | 710/70-34/24   |                                                                                   |                                                                                   | Front                                                                             |                                                                                     |                                                                                     |                                                                                     | 320                | 46  |      |     | 400                              | 58  |
|                      | 710/70R34      |                                                                                   |                                                                                   |                                                                                   |                                                                                     | Front                                                                               |                                                                                     | 320                | 46  |      |     | 400                              | 58  |
| <b>Elephant King</b> | 750/55-26.5/20 |                                                                                   |                                                                                   |                                                                                   | Front, Rear<br>*Front, Rear                                                         |                                                                                     | Front, Rear<br>*Front, Rear                                                         | 450                | 65  | 550  | 80  | 550                              | 80  |
| <b>8 wheels</b>      | 750/55-26.5/24 | Front, Rear                                                                       | Front, Rear                                                                       |                                                                                   |                                                                                     |                                                                                     |                                                                                     | 450                | 65  | 600  | 87  | 600                              | 87  |
|                      | 780/55-26.5/20 |                                                                                   |                                                                                   |                                                                                   | Front, Rear                                                                         |                                                                                     |                                                                                     | 450                | 65  | 550  | 80  | 550                              | 80  |
|                      | 780/50-28.5/24 | Front, Rear                                                                       | Front, Rear                                                                       |                                                                                   |                                                                                     |                                                                                     |                                                                                     | 450                | 65  | 600  | 87  | 600                              | 87  |
|                      | 800/50R26.5    |                                                                                   |                                                                                   |                                                                                   |                                                                                     | Front, Rear                                                                         |                                                                                     | 450                | 65  | 550  | 80  | 550                              | 80  |







## ROTTNE HARVESTERS







| Machine         | Tire size / PR | Tread pattern                                                                     |                                                                                   |                                                                                   |                                                                                    |                                                                                     |                                                                                     | Inflation pressure |     |      |     |                                  |     |  |  |  |  |  |  |  |  |  |  |  |
|-----------------|----------------|-----------------------------------------------------------------------------------|-----------------------------------------------------------------------------------|-----------------------------------------------------------------------------------|------------------------------------------------------------------------------------|-------------------------------------------------------------------------------------|-------------------------------------------------------------------------------------|--------------------|-----|------|-----|----------------------------------|-----|--|--|--|--|--|--|--|--|--|--|--|
|                 |                |  |  |  |  |  |  | Front              |     | Rear |     | Max inflation and track pressure |     |  |  |  |  |  |  |  |  |  |  |  |
|                 |                | F2                                                                                | TRS 2                                                                             | TRS 2+                                                                            | F<br>*Nordman F                                                                    | Rider                                                                               | TRS<br>*Nordman TRS                                                                 | kPa                | psi | kPa  | psi | kPa                              | psi |  |  |  |  |  |  |  |  |  |  |  |
| <b>H8</b>       | 600/55-26.5/20 | Front, Rear                                                                       | Front, Rear                                                                       |                                                                                   | Front, Rear<br>*Front, Rear                                                        |                                                                                     |                                                                                     |                    |     |      |     |                                  |     |  |  |  |  |  |  |  |  |  |  |  |
| <b>4 wheels</b> | 600/55R26.5    |                                                                                   |                                                                                   |                                                                                   |                                                                                    | Front, Rear                                                                         |                                                                                     |                    |     |      |     |                                  |     |  |  |  |  |  |  |  |  |  |  |  |
|                 | 710/45-26.5/20 | Front, Rear                                                                       | Front, Rear                                                                       |                                                                                   | Front, Rear<br>*Front, Rear                                                        |                                                                                     |                                                                                     |                    |     |      |     |                                  |     |  |  |  |  |  |  |  |  |  |  |  |
|                 | 710/45R26.5    |                                                                                   |                                                                                   |                                                                                   |                                                                                    | Front, Rear                                                                         |                                                                                     |                    |     |      |     |                                  |     |  |  |  |  |  |  |  |  |  |  |  |
|                 | 800/40-26.5/20 | Front, Rear                                                                       | Front, Rear                                                                       |                                                                                   | Front, Rear                                                                        |                                                                                     |                                                                                     |                    |     |      |     |                                  |     |  |  |  |  |  |  |  |  |  |  |  |
| <b>H11</b>      | 600/50R24.5    |                                                                                   |                                                                                   |                                                                                   |                                                                                    | Front                                                                               |                                                                                     |                    |     |      |     |                                  |     |  |  |  |  |  |  |  |  |  |  |  |
| <b>6 wheels</b> | 650/45R24.5    |                                                                                   |                                                                                   |                                                                                   |                                                                                    | Front                                                                               |                                                                                     |                    |     |      |     |                                  |     |  |  |  |  |  |  |  |  |  |  |  |
|                 | 710/40-24.5    | Front                                                                             | Front                                                                             |                                                                                   | Front, *Front                                                                      |                                                                                     |                                                                                     |                    |     |      |     |                                  |     |  |  |  |  |  |  |  |  |  |  |  |
|                 | 800/40-24.5/20 | Front                                                                             | Front                                                                             |                                                                                   |                                                                                    |                                                                                     |                                                                                     |                    |     |      |     |                                  |     |  |  |  |  |  |  |  |  |  |  |  |
|                 | 600/65-34/20   |                                                                                   |                                                                                   |                                                                                   |                                                                                    |                                                                                     |                                                                                     |                    |     |      |     |                                  |     |  |  |  |  |  |  |  |  |  |  |  |
|                 | 600/65-34/24   |                                                                                   |                                                                                   |                                                                                   |                                                                                    |                                                                                     |                                                                                     |                    |     |      |     |                                  |     |  |  |  |  |  |  |  |  |  |  |  |
|                 | 600/65R34      |                                                                                   |                                                                                   |                                                                                   |                                                                                    | Rear                                                                                |                                                                                     |                    |     |      |     |                                  |     |  |  |  |  |  |  |  |  |  |  |  |
|                 | 700/55-34/20   |                                                                                   |                                                                                   |                                                                                   |                                                                                    |                                                                                     |                                                                                     |                    |     |      |     |                                  |     |  |  |  |  |  |  |  |  |  |  |  |
|                 | 710/55-34/24   |                                                                                   |                                                                                   |                                                                                   |                                                                                    |                                                                                     |                                                                                     |                    |     |      |     |                                  |     |  |  |  |  |  |  |  |  |  |  |  |
|                 | 710/55R34      |                                                                                   |                                                                                   |                                                                                   |                                                                                    | Rear                                                                                |                                                                                     |                    |     |      |     |                                  |     |  |  |  |  |  |  |  |  |  |  |  |
| <b>H11c</b>     | 600/50R24.5    |                                                                                   |                                                                                   |                                                                                   |                                                                                    | Front, Rear                                                                         |                                                                                     |                    |     |      |     |                                  |     |  |  |  |  |  |  |  |  |  |  |  |
| <b>8 wheels</b> | 650/45R24.5    |                                                                                   |                                                                                   |                                                                                   |                                                                                    | Front, Rear                                                                         |                                                                                     |                    |     |      |     |                                  |     |  |  |  |  |  |  |  |  |  |  |  |

| Machine         | Tire size / PR | Tread pattern                                                                     |                                                                                   |                                                                                   |                                                                                    |                                                                                     |                                                                                     | Inflation pressure |     |      |     |                                  |     |
|-----------------|----------------|-----------------------------------------------------------------------------------|-----------------------------------------------------------------------------------|-----------------------------------------------------------------------------------|------------------------------------------------------------------------------------|-------------------------------------------------------------------------------------|-------------------------------------------------------------------------------------|--------------------|-----|------|-----|----------------------------------|-----|
|                 |                |  |  |  |  |  |  | Front              |     | Rear |     | Max inflation and track pressure |     |
|                 |                | F2                                                                                | TRS 2                                                                             | TRS 2+                                                                            | F<br>*Nordman F                                                                    | Rider                                                                               | TRS<br>*Nordman TRS                                                                 | kPa                | psi | kPa  | psi | kPa                              | psi |
|                 | 710/40-24.5    | Front, Rear                                                                       | Front, Rear                                                                       |                                                                                   | Front, Rear<br>*Front, Rear                                                        |                                                                                     |                                                                                     | 500                | 73  | 450  | 65  | 550                              | 80  |
| <b>H14c</b>     | 600/55-26.5/20 | Front                                                                             | Front                                                                             |                                                                                   | Front, *Front                                                                      |                                                                                     |                                                                                     | 500                | 73  |      |     | 550                              | 80  |
| <b>6 wheels</b> | 600/55R26.5    |                                                                                   |                                                                                   |                                                                                   |                                                                                    | Front                                                                               |                                                                                     | 500                | 73  |      |     | 550                              | 80  |
|                 | 710/45-26.5/20 | Front                                                                             | Front                                                                             |                                                                                   | Front, *Front                                                                      |                                                                                     |                                                                                     | 500                | 73  |      |     | 550                              | 80  |
|                 | 710/45R26.5    |                                                                                   |                                                                                   |                                                                                   |                                                                                    | Front                                                                               |                                                                                     | 500                | 73  |      |     | 550                              | 80  |
|                 | 800/40-26.5/20 | Front                                                                             | Front                                                                             |                                                                                   | Front                                                                              |                                                                                     |                                                                                     | 500                | 73  |      |     | 550                              | 80  |
|                 | 600/65-34/20   |                                                                                   |                                                                                   |                                                                                   |                                                                                    |                                                                                     |                                                                                     |                    |     | 280  | 41  | 360                              | 52  |
|                 | 600/65-34/24   |                                                                                   |                                                                                   | Rear                                                                              |                                                                                    |                                                                                     |                                                                                     |                    |     | 280  | 41  | 400                              | 58  |
|                 | 600/65R34      |                                                                                   |                                                                                   |                                                                                   |                                                                                    | Rear                                                                                |                                                                                     |                    |     | 280  | 41  | 400                              | 58  |
|                 | 700/55-34/20   |                                                                                   |                                                                                   |                                                                                   |                                                                                    |                                                                                     |                                                                                     |                    |     | 280  | 41  | 360                              | 52  |
|                 | 710/55-34/24   |                                                                                   |                                                                                   | Rear                                                                              |                                                                                    |                                                                                     |                                                                                     |                    |     | 280  | 41  | 400                              | 58  |
|                 | 710/55R34      |                                                                                   |                                                                                   |                                                                                   |                                                                                    | Rear                                                                                |                                                                                     |                    |     | 280  | 41  | 400                              | 58  |
| <b>H20b</b>     | 750/55-26.5/20 |                                                                                   |                                                                                   |                                                                                   | Front, *Front                                                                      |                                                                                     |                                                                                     | 500                | 73  |      |     | 550                              | 80  |
| <b>6 wheels</b> | 750/55-26.5/24 | Front                                                                             | Front                                                                             |                                                                                   |                                                                                    |                                                                                     |                                                                                     | 500                | 73  |      |     | 550                              | 80  |
|                 | 780/55-26.5/20 |                                                                                   |                                                                                   |                                                                                   | Front                                                                              |                                                                                     |                                                                                     | 500                | 73  |      |     | 550                              | 80  |
|                 | 700/70-34/16   |                                                                                   |                                                                                   |                                                                                   |                                                                                    |                                                                                     |                                                                                     |                    |     | 260  | 38  | 260                              | 38  |
|                 | 700/70-34/20   |                                                                                   |                                                                                   |                                                                                   |                                                                                    |                                                                                     |                                                                                     |                    |     | 300  | 44  | 360                              | 52  |
|                 | 710/70-34/24   |                                                                                   |                                                                                   | Rear                                                                              |                                                                                    |                                                                                     |                                                                                     |                    |     | 300  | 44  | 400                              | 58  |
|                 | 710/70R34      |                                                                                   |                                                                                   |                                                                                   |                                                                                    | Rear                                                                                |                                                                                     |                    |     | 300  | 44  | 400                              | 58  |

| Machine         | Tire size / PR | Tread pattern                                                                     |                                                                                   |                                                                                   |                                                                                    |                                                                                     |                                                                                     | Inflation pressure |     |      |     |                                  |     |    |
|-----------------|----------------|-----------------------------------------------------------------------------------|-----------------------------------------------------------------------------------|-----------------------------------------------------------------------------------|------------------------------------------------------------------------------------|-------------------------------------------------------------------------------------|-------------------------------------------------------------------------------------|--------------------|-----|------|-----|----------------------------------|-----|----|
|                 |                |  |  |  |  |  |  | Front              |     | Rear |     | Max inflation and track pressure |     |    |
|                 |                | F2                                                                                | TRS 2                                                                             | TRS 2+                                                                            | F<br>*Nordman F                                                                    | Rider                                                                               | TRS<br>*Nordman TRS                                                                 | kPa                | psi | kPa  | psi | kPa                              | psi |    |
| <b>H21d</b>     | 750/55-26.5/20 |                                                                                   |                                                                                   |                                                                                   | Front, Rear<br>*Front, Rear                                                        |                                                                                     |                                                                                     | *Front, Rear       | 500 | 73   | 450 | 65                               | 550 | 80 |
| <b>8 wheels</b> | 750/55-26.5/24 | Front, Rear                                                                       | Front, Rear                                                                       |                                                                                   |                                                                                    |                                                                                     |                                                                                     |                    | 500 | 73   | 450 | 65                               | 600 | 87 |
|                 | 780/55-26.5/20 |                                                                                   |                                                                                   |                                                                                   | Front                                                                              |                                                                                     |                                                                                     |                    | 500 | 73   | 450 | 65                               | 550 | 80 |
| <b>H21d</b>     | 750/55-26.5/20 |                                                                                   |                                                                                   |                                                                                   | Front, Rear<br>*Front, Rear                                                        |                                                                                     |                                                                                     | *Front, Rear       | 500 | 73   | 450 | 65                               | 550 | 80 |
| <b>6 wheels</b> | 750/55-26.5/24 | Front, Rear                                                                       | Front, Rear                                                                       |                                                                                   |                                                                                    |                                                                                     |                                                                                     |                    | 500 | 73   | 450 | 65                               | 600 | 87 |
|                 | 780/55-26.5/20 |                                                                                   |                                                                                   |                                                                                   | Front                                                                              |                                                                                     |                                                                                     |                    | 500 | 73   | 450 | 65                               | 550 | 80 |
|                 | 700/70-34/16   |                                                                                   |                                                                                   |                                                                                   |                                                                                    |                                                                                     |                                                                                     | Rear               |     |      | 260 | 38                               | 260 | 38 |
|                 | 700/70-34/20   |                                                                                   |                                                                                   |                                                                                   |                                                                                    |                                                                                     |                                                                                     | *Rear              |     |      | 300 | 44                               | 360 | 52 |
|                 | 710/70-34/24   |                                                                                   |                                                                                   | Rear                                                                              |                                                                                    |                                                                                     |                                                                                     |                    |     |      | 300 | 44                               | 400 | 58 |
|                 | 710/70R34      |                                                                                   |                                                                                   |                                                                                   |                                                                                    | Rear                                                                                |                                                                                     |                    |     |      | 300 | 44                               | 400 | 58 |

## ROTTNE FORWARDERS





| Machine         | Tire size / PR | Tread pattern                                                                       |                                                                                     |                                                                                     |                                                                                      |                                                                                       |                                                                                       | Inflation pressure |     |      |     |                                  |     |    |
|-----------------|----------------|-------------------------------------------------------------------------------------|-------------------------------------------------------------------------------------|-------------------------------------------------------------------------------------|--------------------------------------------------------------------------------------|---------------------------------------------------------------------------------------|---------------------------------------------------------------------------------------|--------------------|-----|------|-----|----------------------------------|-----|----|
|                 |                |  |  |  |  |  |  | Front              |     | Rear |     | Max inflation and track pressure |     |    |
|                 |                | F2                                                                                  | TRS 2                                                                               | TRS 2+                                                                              | F<br>*Nordman F                                                                      | Rider                                                                                 | TRS<br>*Nordman TRS                                                                   | kPa                | psi | kPa  | psi | kPa                              | psi |    |
| <b>F10b</b>     | 600/50-22.5/20 | Front, Rear                                                                         | Front, Rear                                                                         |                                                                                     |                                                                                      |                                                                                       |                                                                                       | Front, Rear        | 350 | 51   | 500 | 73                               | 550 | 80 |
| <b>8 wheels</b> | 710/40-22.5/16 |                                                                                     |                                                                                     |                                                                                     | Front, Rear                                                                          |                                                                                       |                                                                                       |                    | 350 | 51   | 400 | 58                               | 550 | 80 |

| Machine         | Tire size / PR | Tread pattern                                                                     |                                                                                   |                                                                                   |                                                                                    |                                                                                     |                                                                                     | Inflation pressure |     |      |     |                                  |     |
|-----------------|----------------|-----------------------------------------------------------------------------------|-----------------------------------------------------------------------------------|-----------------------------------------------------------------------------------|------------------------------------------------------------------------------------|-------------------------------------------------------------------------------------|-------------------------------------------------------------------------------------|--------------------|-----|------|-----|----------------------------------|-----|
|                 |                |  |  |  |  |  |  | Front              |     | Rear |     | Max inflation and track pressure |     |
|                 |                | F2                                                                                | TRS 2                                                                             | TRS 2+                                                                            | F *Nordman F                                                                       | Rider                                                                               | TRS *Nordman TRS                                                                    | kPa                | psi | kPa  | psi | kPa                              | psi |
|                 | 710/40-22.5/20 | Front, Rear                                                                       | Front, Rear                                                                       |                                                                                   |                                                                                    |                                                                                     |                                                                                     | 350                | 51  | 500  | 73  | 550                              | 80  |
| <b>F10d</b>     | 600/50-22.5/20 | Front, Rear                                                                       | Front, Rear                                                                       |                                                                                   |                                                                                    |                                                                                     | Front, Rear                                                                         | 350                | 51  | 550  | 80  | 550                              | 80  |
| <b>8 wheels</b> | 710/40-22.5/20 | Front, Rear                                                                       | Front, Rear                                                                       |                                                                                   |                                                                                    |                                                                                     |                                                                                     | 350                | 51  | 550  | 80  | 550                              | 80  |
| <b>F11d</b>     | 600/50-24.5/20 |                                                                                   | Front, Rear                                                                       |                                                                                   |                                                                                    |                                                                                     |                                                                                     | 350                | 51  | 550  | 80  | 550                              | 80  |
| <b>8 wheels</b> | 710/40-24.5/20 | Front, Rear                                                                       | Front, Rear                                                                       |                                                                                   | Front, Rear<br>*Front, Rear                                                        |                                                                                     |                                                                                     | 350                | 51  | 550  | 80  | 550                              | 80  |
|                 | 800/40-24.5/20 | Front, Rear                                                                       | Front, Rear                                                                       |                                                                                   |                                                                                    |                                                                                     |                                                                                     | 350                | 51  | 550  | 80  | 550                              | 80  |
| <b>F13c</b>     | 600/55-26.5/20 | Front, Rear                                                                       | Front, Rear                                                                       |                                                                                   | Front, Rear<br>*Front, Rear                                                        |                                                                                     | *Front, Rear                                                                        | 350                | 51  | 550  | 80  | 550                              | 80  |
| <b>8 wheels</b> | 600/55R26.5    |                                                                                   |                                                                                   |                                                                                   |                                                                                    | Front, Rear                                                                         |                                                                                     | 350                | 51  | 550  | 80  | 550                              | 80  |
|                 | 710/45-26.5/20 | Front, Rear                                                                       | Front, Rear                                                                       |                                                                                   | Front, Rear<br>*Front, Rear                                                        |                                                                                     | *Front, Rear                                                                        | 350                | 51  | 500  | 73  | 550                              | 80  |
|                 | 710/45R26.5    |                                                                                   |                                                                                   |                                                                                   |                                                                                    | Front, Rear                                                                         |                                                                                     | 350                | 51  | 500  | 73  | 550                              | 80  |
|                 | 800/40-26.5/20 | Front, Rear                                                                       | Front, Rear                                                                       |                                                                                   | Front, Rear                                                                        |                                                                                     |                                                                                     | 350                | 51  | 500  | 73  | 550                              | 80  |
| <b>F15c</b>     | 600/55-26.5/20 | Front, Rear                                                                       | Front, Rear                                                                       |                                                                                   | Front, Rear<br>*Front, Rear                                                        |                                                                                     | *Front, Rear                                                                        | 450                | 65  | 550  | 80  | 550                              | 80  |
| <b>8 wheels</b> | 600/55R26.5    |                                                                                   |                                                                                   |                                                                                   |                                                                                    | Front, Rear                                                                         |                                                                                     | 450                | 65  | 550  | 80  | 550                              | 80  |
|                 | 710/45-26.5/20 | Front, Rear                                                                       | Front, Rear                                                                       |                                                                                   | Front, Rear<br>*Front, Rear                                                        |                                                                                     | *Front, Rear                                                                        | 400                | 58  | 550  | 80  | 550                              | 80  |
|                 | 710/45R26.5    |                                                                                   |                                                                                   |                                                                                   |                                                                                    | Front, Rear                                                                         |                                                                                     | 400                | 58  | 550  | 80  | 550                              | 80  |
|                 | 800/40-26.5/20 | Front, Rear                                                                       | Front, Rear                                                                       |                                                                                   | Front, Rear                                                                        |                                                                                     |                                                                                     | 400                | 58  | 550  | 80  | 550                              | 80  |
| <b>F18</b>      | 750/55-26.5/20 |                                                                                   |                                                                                   |                                                                                   | Rear, *Rear                                                                        |                                                                                     | Rear, *Rear                                                                         |                    |     | 550  | 80  | 550                              | 80  |

| Machine         | Tire size / PR | Tread pattern                                                                     |                                                                                   |                                                                                   |                                                                                    |                                                                                     |                                                                                     | Inflation pressure |     |      |     |                                  |     |
|-----------------|----------------|-----------------------------------------------------------------------------------|-----------------------------------------------------------------------------------|-----------------------------------------------------------------------------------|------------------------------------------------------------------------------------|-------------------------------------------------------------------------------------|-------------------------------------------------------------------------------------|--------------------|-----|------|-----|----------------------------------|-----|
|                 |                |  |  |  |  |  |  | Front              |     | Rear |     | Max inflation and track pressure |     |
|                 |                | F2                                                                                | TRS 2                                                                             | TRS 2+                                                                            | F *Nordman F                                                                       | Rider                                                                               | TRS *Nordman TRS                                                                    | kPa                | psi | kPa  | psi | kPa                              | psi |
| <b>6 wheels</b> | 750/55-26.5/24 | Rear                                                                              | Rear                                                                              |                                                                                   |                                                                                    |                                                                                     |                                                                                     |                    |     | 600  | 87  | 600                              | 87  |
|                 | 780/55-26.5/20 |                                                                                   |                                                                                   |                                                                                   | Rear                                                                               |                                                                                     |                                                                                     |                    |     | 550  | 80  | 550                              | 80  |
|                 | 700/70-34/16   |                                                                                   |                                                                                   |                                                                                   |                                                                                    |                                                                                     | Front                                                                               | 260                | 38  |      |     | 260                              | 38  |
|                 | 700/70-34/20   |                                                                                   |                                                                                   |                                                                                   |                                                                                    |                                                                                     | *Front                                                                              | 320                | 46  |      |     | 360                              | 52  |
|                 | 710/70-34/24   |                                                                                   |                                                                                   | Front                                                                             |                                                                                    |                                                                                     |                                                                                     | 320                | 46  |      |     | 400                              | 58  |
|                 | 710/70R34      |                                                                                   |                                                                                   |                                                                                   |                                                                                    | Front                                                                               |                                                                                     | 320                | 46  |      |     | 400                              | 58  |
| <b>F18</b>      | 750/55-26.5/20 |                                                                                   |                                                                                   |                                                                                   | Front, Rear<br>*Front, Rear                                                        |                                                                                     | Front, Rear<br>*Front, Rear                                                         | 450                | 65  | 550  | 80  | 550                              | 80  |
| <b>8 wheels</b> | 750/55-26.5/24 | Front, Rear                                                                       | Front, Rear                                                                       |                                                                                   |                                                                                    |                                                                                     |                                                                                     | 450                | 65  | 600  | 87  | 600                              | 87  |
|                 | 780/55-26.5/20 |                                                                                   |                                                                                   |                                                                                   | Front, Rear                                                                        |                                                                                     |                                                                                     | 450                | 65  | 550  | 80  | 550                              | 80  |
| <b>F20</b>      | 750/55-26.5/24 | Front, Rear                                                                       | Front, Rear                                                                       |                                                                                   |                                                                                    |                                                                                     |                                                                                     | 450                | 65  | 600  | 87  | 600                              | 87  |
| <b>8 wheels</b> | 780/50-28.5/24 | Front, Rear                                                                       | Front, Rear                                                                       |                                                                                   |                                                                                    |                                                                                     |                                                                                     | 450                | 65  | 600  | 87  | 600                              | 87  |





## TIGERCAT HARVESTERS

| Machine         | Tire size / PR | Tread pattern                                                                       |                                                                                     |                                                                                     |                                                                                      |                                                                                       | Inflation pressure |     |      |     |                                  |     |
|-----------------|----------------|-------------------------------------------------------------------------------------|-------------------------------------------------------------------------------------|-------------------------------------------------------------------------------------|--------------------------------------------------------------------------------------|---------------------------------------------------------------------------------------|--------------------|-----|------|-----|----------------------------------|-----|
|                 |                |  |  |  |  |  | Front              |     | Rear |     | Max inflation and track pressure |     |
|                 |                | F2                                                                                  | TRS 2                                                                               | TRS 2+                                                                              | F *Nordman F                                                                         | TRS *Nordman TRS                                                                      | kPa                | psi | kPa  | psi | kPa                              | psi |
| <b>1165</b>     | 600/55-26.5/20 | Front                                                                               | Front                                                                               |                                                                                     | Front                                                                                | Front                                                                                 | 550                | 80  | 400  | 58  | 550                              | 80  |
| <b>6 wheels</b> | 710/45-26.5/20 | Front                                                                               | Front                                                                               |                                                                                     | Front                                                                                | Front                                                                                 | 550                | 80  | 400  | 58  | 550                              | 80  |



| Machine         | Tire size / PR | Tread pattern                                                                     |                                                                                   |                                                                                   |                                                                                     |                                                                                     | Inflation pressure |     |      |     |                                  |     |
|-----------------|----------------|-----------------------------------------------------------------------------------|-----------------------------------------------------------------------------------|-----------------------------------------------------------------------------------|-------------------------------------------------------------------------------------|-------------------------------------------------------------------------------------|--------------------|-----|------|-----|----------------------------------|-----|
|                 |                |  |  |  |  |  | Front              |     | Rear |     | Max inflation and track pressure |     |
|                 |                | F2                                                                                | TRS 2                                                                             | TRS 2+                                                                            | F<br>*Nordman F                                                                     | TRS<br>*Nordman TRS                                                                 | kPa                | psi | kPa  | psi | kPa                              | psi |
|                 | 710/45-26.5/24 | Front                                                                             | Front                                                                             |                                                                                   |                                                                                     |                                                                                     | 600                | 87  | 400  | 58  | 600                              | 87  |
|                 | 600/65-34/24   |                                                                                   |                                                                                   | Rear                                                                              |                                                                                     |                                                                                     |                    |     | 400  | 58  | 400                              | 58  |
|                 | 710/55-34/24   |                                                                                   |                                                                                   | Rear                                                                              |                                                                                     |                                                                                     |                    |     | 400  | 58  | 400                              | 58  |
| <b>1165</b>     | 710/45-26.5/20 | Front, Rear                                                                       | Front, Rear                                                                       |                                                                                   | Front, Rear                                                                         | Front, Rear                                                                         | 550                | 80  | 400  | 58  | 550                              | 80  |
| <b>8 wheels</b> | 710/45-26.5/24 | Front, Rear                                                                       | Front, Rear                                                                       |                                                                                   | Front, Rear                                                                         | Front, Rear                                                                         | 600                | 87  | 400  | 58  | 600                              | 87  |
| <b>1185</b>     | 750/55-26.5/20 |                                                                                   |                                                                                   |                                                                                   | Front, Rear                                                                         | Front, Rear                                                                         | 550                | 80  | 450  | 65  | 550                              | 80  |
| <b>8 wheels</b> | 750/55-26.5/24 | Front, Rear                                                                       | Front, Rear                                                                       |                                                                                   |                                                                                     |                                                                                     | 600                | 87  | 450  | 65  | 600                              | 87  |
|                 | 710/55-28.5/24 | Front, Rear                                                                       | Front, Rear                                                                       |                                                                                   |                                                                                     |                                                                                     | 600                | 87  | 450  | 65  | 600                              | 87  |
|                 | 780/50-28.5/24 | Front, Rear                                                                       | Front, Rear                                                                       |                                                                                   |                                                                                     |                                                                                     | 600                | 87  | 450  | 65  | 600                              | 87  |



## TIGERCAT FORWARDERS

| Machine         | Tire size / PR | Tread pattern                                                                       |                                                                                     |                                                                                      |                                                                                       | Inflation pressure |     |      |     |                                  |     |
|-----------------|----------------|-------------------------------------------------------------------------------------|-------------------------------------------------------------------------------------|--------------------------------------------------------------------------------------|---------------------------------------------------------------------------------------|--------------------|-----|------|-----|----------------------------------|-----|
|                 |                |  |  |  |  | Front              |     | Rear |     | Max inflation and track pressure |     |
|                 |                | F2                                                                                  | TRS 2                                                                               | F<br>*Nordman F                                                                      | TRS<br>*Nordman TRS                                                                   | kPa                | psi | kPa  | psi | kPa                              | psi |
| <b>1055C</b>    | 600/50-26.5/20 | Front, Rear                                                                         | Front, Rear                                                                         | Front, Rear                                                                          | Front, Rear                                                                           | 550                | 80  | 550  | 80  | 550                              | 80  |
| <b>8 wheels</b> | 710/45-26.5/20 | Front, Rear                                                                         | Front, Rear                                                                         | Front, Rear                                                                          | Front, Rear                                                                           | 550                | 80  | 550  | 80  | 550                              | 80  |
|                 | 710/45-26.5/24 | Front, Rear                                                                         |                                                                                     |                                                                                      |                                                                                       | 600                | 87  | 600  | 87  | 600                              | 87  |
|                 | 800/40-26.5/20 | Front, Rear                                                                         | Front, Rear                                                                         | Front, Rear                                                                          |                                                                                       | 550                | 80  | 550  | 80  | 550                              | 80  |



| Machine         | Tire size / PR | Tread pattern                                                                     |                                                                                   |                                                                                    |                                                                                     | Inflation pressure |     |      |     |                                  |     |
|-----------------|----------------|-----------------------------------------------------------------------------------|-----------------------------------------------------------------------------------|------------------------------------------------------------------------------------|-------------------------------------------------------------------------------------|--------------------|-----|------|-----|----------------------------------|-----|
|                 |                |  |  |  |  | Front              |     | Rear |     | Max inflation and track pressure |     |
|                 |                | F2                                                                                | TRS 2                                                                             | F<br>*Nordman F                                                                    | TRS<br>*Nordman TRS                                                                 | kPa                | psi | kPa  | psi | kPa                              | psi |
| <b>1075C</b>    | 750/55-26.5/20 |                                                                                   |                                                                                   | Front, Rear                                                                        | Front, Rear                                                                         | 600                | 87  | 600  | 87  | 600                              | 87  |
| <b>8 wheels</b> | 750/55-26.5/24 | Front, Rear                                                                       | Front, Rear                                                                       |                                                                                    |                                                                                     | 600                | 87  | 600  | 87  | 600                              | 87  |
|                 | 780/50-28.5/24 | Front, Rear                                                                       | Front, Rear                                                                       |                                                                                    |                                                                                     | 600                | 87  | 600  | 87  | 600                              | 87  |
| <b>1085C</b>    | 750/55-26.5/24 | Front, Rear                                                                       | Front, Rear                                                                       |                                                                                    |                                                                                     | 600                | 87  | 600  | 87  | 600                              | 87  |
| <b>8 wheels</b> | 780/50-28.5/24 | Front, Rear                                                                       | Front, Rear                                                                       |                                                                                    |                                                                                     | 600                | 87  | 600  | 87  | 600                              | 87  |

## ECOLOG HARVESTERS

| Machine          | Tire size / PR | Tread pattern                                                                     |                                                                                   |                                                                                     | Inflation pressure |     |      |     |                                  |     |
|------------------|----------------|-----------------------------------------------------------------------------------|-----------------------------------------------------------------------------------|-------------------------------------------------------------------------------------|--------------------|-----|------|-----|----------------------------------|-----|
|                  |                |  |  |  | Front              |     | Rear |     | Max inflation and track pressure |     |
|                  |                | F2                                                                                | TRS 2                                                                             | TRS 2+                                                                              | kPa                | psi | kPa  | psi | kPa                              | psi |
| <b>1058H5</b>    | 600/55-22.5/20 | Front, Rear                                                                       | Front, Rear                                                                       |                                                                                     | 400                | 58  | 350  | 51  | 550                              | 80  |
| <b>8 wheels</b>  | 710/45-22.5/20 | Front, Rear                                                                       | Front, Rear                                                                       |                                                                                     | 400                | 58  | 350  | 51  | 550                              | 80  |
| <b>550F</b>      | 600/65-34/24   |                                                                                   |                                                                                   | Front, Rear                                                                         | 300                | 44  | 300  | 44  | 400                              | 58  |
| <b>4 wheels</b>  | 710/55-34/24   |                                                                                   |                                                                                   | Front, Rear                                                                         | 300                | 44  | 300  | 44  | 400                              | 58  |
| <b>550 T-PRO</b> | 600/55-26.5/20 | Front                                                                             | Front                                                                             |                                                                                     | 400                | 58  |      |     | 550                              | 80  |
| <b>6 wheels</b>  | 710/45-26.5/20 | Front                                                                             | Front                                                                             |                                                                                     | 400                | 58  |      |     | 550                              | 80  |
|                  | 600/65-34/20   |                                                                                   |                                                                                   | Rear                                                                                |                    |     | 350  | 51  | 400                              | 58  |
|                  | 710/55-34/20   |                                                                                   |                                                                                   | Rear                                                                                |                    |     | 350  | 51  | 400                              | 58  |
| <b>560F</b>      | 600/55-26.5/20 | Front                                                                             | Front                                                                             |                                                                                     | 450                | 65  |      |     | 550                              | 80  |
| <b>6 wheels</b>  | 710/45-26.5/20 | Front                                                                             | Front                                                                             |                                                                                     | 450                | 65  |      |     | 550                              | 80  |
|                  | 600/65-34/20   |                                                                                   |                                                                                   | Rear                                                                                |                    |     | 350  | 51  | 400                              | 58  |
|                  | 710/55-34/20   |                                                                                   |                                                                                   | Rear                                                                                |                    |     | 350  | 51  | 400                              | 58  |
| <b>580F</b>      | 600/55-26.5/20 | Front                                                                             | Front                                                                             |                                                                                     | 500                | 73  |      |     | 550                              | 80  |
| <b>6 wheels</b>  | 710/45-26.5/20 | Front                                                                             | Front                                                                             |                                                                                     | 500                | 73  |      |     | 550                              | 80  |
|                  | 600/65-34/24   |                                                                                   |                                                                                   | Rear                                                                                |                    |     | 350  |     | 400                              | 58  |
|                  | 710/55-34/24   |                                                                                   |                                                                                   | Rear                                                                                |                    |     | 350  |     | 400                              | 58  |
| <b>590F</b>      | 710/55-26.5/24 | Front                                                                             | Front                                                                             |                                                                                     |                    |     |      |     | 600                              | 87  |
| <b>6 wheels</b>  | 710/55-28.5/24 | Front                                                                             | Front                                                                             |                                                                                     |                    |     |      |     | 600                              | 87  |
|                  | 710/55-34/24   |                                                                                   |                                                                                   | Rear                                                                                |                    |     |      |     | 400                              | 58  |

| Machine         | Tire size / PR | Tread pattern                                                                     |                                                                                   |                                                                                     | Inflation pressure |     |      |     |                                  |     |
|-----------------|----------------|-----------------------------------------------------------------------------------|-----------------------------------------------------------------------------------|-------------------------------------------------------------------------------------|--------------------|-----|------|-----|----------------------------------|-----|
|                 |                |  |  |  | Front              |     | Rear |     | Max inflation and track pressure |     |
|                 |                | F2                                                                                | TRS 2                                                                             | TRS 2+                                                                              | kPa                | psi | kPa  | psi | kPa                              | psi |
|                 | 710/70-34/24   |                                                                                   |                                                                                   | Rear                                                                                |                    |     |      |     | 400                              | 58  |
| <b>688F</b>     | 600/55-26.5/20 | Front, Rear                                                                       | Front, Rear                                                                       |                                                                                     |                    |     |      |     | 550                              | 80  |
| <b>8 wheels</b> | 710/45-26.5/20 | Front, Rear                                                                       | Front, Rear                                                                       |                                                                                     |                    |     |      |     | 550                              | 80  |
|                 | 800/40-26.5/20 | Front, Rear                                                                       | Front, Rear                                                                       |                                                                                     |                    |     |      |     | 550                              | 80  |

## ECOLOG FORWARDERS

| Machine         | Tire size / PR | Tread pattern                                                                     |                                                                                    | Inflation pressure |     |      |     |                                  |     |
|-----------------|----------------|-----------------------------------------------------------------------------------|------------------------------------------------------------------------------------|--------------------|-----|------|-----|----------------------------------|-----|
|                 |                |  |  | Front              |     | Rear |     | Max inflation and track pressure |     |
|                 |                | F2                                                                                | TRS 2                                                                              | kPa                | psi | kPa  | psi | kPa                              | psi |
| <b>750F</b>     | 600/55-22.5/20 | Front, Rear                                                                       | Front, Rear                                                                        | 350                | 51  | 500  | 73  | 550                              | 80  |
| <b>8 wheels</b> | 710/45-22.5/20 | Front, Rear                                                                       | Front, Rear                                                                        | 350                | 51  | 500  | 73  | 550                              | 80  |
| <b>1050F</b>    | 600/55-22.5/20 | Front, Rear                                                                       | Front, Rear                                                                        | 350                | 51  | 500  | 73  | 550                              | 80  |
| <b>8 wheels</b> | 710/45-22.5/20 | Front, Rear                                                                       | Front, Rear                                                                        | 350                | 51  | 500  | 73  | 550                              | 80  |
| <b>1250F</b>    | 600/55-26.5/20 | Front, Rear                                                                       | Front, Rear                                                                        | 400                | 58  | 550  | 80  | 550                              | 80  |
| <b>8 wheels</b> | 710/45-26.5/20 | Front, Rear                                                                       | Front, Rear                                                                        | 400                | 58  | 500  | 73  | 550                              | 80  |
|                 | 710/45-26.5/24 | Front, Rear                                                                       | Front, Rear                                                                        | 400                | 58  | 500  | 73  | 600                              | 87  |
|                 | 800/40-26.5/20 | Front, Rear                                                                       | Front, Rear                                                                        | 400                | 58  | 500  | 73  | 550                              | 80  |
| <b>574F</b>     | 600/55-26.5/20 | Front, Rear                                                                       | Front, Rear                                                                        | 400                | 58  | 550  | 80  | 550                              | 80  |
| <b>8 wheels</b> | 710/45-26.5/20 | Front, Rear                                                                       | Front, Rear                                                                        | 400                | 58  | 550  | 80  | 550                              | 80  |

| Machine         | Tire size / PR | Tread pattern                                                                           |                                                                                             | Inflation pressure |     |      |     |                                  |     |
|-----------------|----------------|-----------------------------------------------------------------------------------------|---------------------------------------------------------------------------------------------|--------------------|-----|------|-----|----------------------------------|-----|
|                 |                | <br>F2 | <br>TRS 2 | Front              |     | Rear |     | Max inflation and track pressure |     |
|                 |                |                                                                                         |                                                                                             | kPa                | psi | kPa  | psi | kPa                              | psi |
|                 | 710/45-26.5/24 | Front, Rear                                                                             | Front, Rear                                                                                 | 400                | 58  | 550  | 80  | 600                              | 87  |
|                 | 800/40-26.5/20 | Front, Rear                                                                             | Front, Rear                                                                                 | 400                | 58  | 550  | 80  | 550                              | 80  |
| <b>584F</b>     | 710/45-26.5/20 | Front, Rear                                                                             | Front, Rear                                                                                 | 400                | 58  | 550  | 80  | 550                              | 80  |
| <b>8 wheels</b> | 710/45-26.5/24 | Front, Rear                                                                             | Front, Rear                                                                                 | 400                | 58  | 600  | 87  | 600                              | 87  |
|                 | 800/40-26.5/20 | Front, Rear                                                                             | Front, Rear                                                                                 | 400                | 58  | 550  | 80  | 550                              | 80  |
| <b>594F</b>     | 750/55-26.5/24 | Front, Rear                                                                             | Front, Rear                                                                                 | 450                | 65  | 600  | 87  | 600                              | 87  |
| <b>8 wheels</b> | 710/55-28.5/24 | Front, Rear                                                                             | Front, Rear                                                                                 | 450                | 65  | 600  | 87  | 600                              | 87  |
|                 | 780/55-28.5/24 | Front, Rear                                                                             | Front, Rear                                                                                 | 450                | 65  | 600  | 87  | 600                              | 87  |

# GROUND CONTACT PRESSURE COMPARISON

## GROUND PRESSURE COMPARISON BETWEEN DIFFERENT TIRE SIZES

Both the tire diameter and width have an important role in determining the size of tire contact area. In practice the tire diameter increase has greater effect on machine mobility than the width increase. Due to the variation in operating ground the absolute ground pressure values can be difficult to assess. However the information in this table is useful when comparing the relative performance of different tires.

### CONTACT AREA AND GROUND PRESSURE AT DIFFERENT TYRE LOADS. SOFT SOIL.

| Size            | 600/50-22.5            |                          | 710/40-22.5              |                          | 710/40-24.5              |                          | 500/60-26.5              |                          | 600/55-26.5              |                          | 650/60-26.5              |                          | 650/65-26.5              |                          | 710/45-26.5              |                          |                          |
|-----------------|------------------------|--------------------------|--------------------------|--------------------------|--------------------------|--------------------------|--------------------------|--------------------------|--------------------------|--------------------------|--------------------------|--------------------------|--------------------------|--------------------------|--------------------------|--------------------------|--------------------------|
|                 | mm                     | in                       | mm                       | in                       | mm                       | in                       | mm                       | in                       | mm                       | in                       | mm                       | in                       | mm                       | in                       | mm                       | in                       |                          |
| <b>Diameter</b> | 1171                   | 46,1                     | 1171                     | 46,1                     | 1230                     | 48,4                     | 1273                     | 50,1                     | 1340                     | 52,8                     | 1485                     | 58,5                     | 1485                     | 58,5                     | 1340                     | 52,8                     |                          |
| <b>Width</b>    | 601                    | 23,7                     | 710                      | 28,0                     | 710                      | 28,0                     | 503                      | 19,8                     | 601                      | 23,7                     | 650                      | 25,6                     | 650                      | 25,6                     | 710                      | 28,0                     |                          |
|                 | cm <sup>2</sup>        | in <sup>2</sup>          | cm <sup>2</sup>          | in <sup>2</sup>          | cm <sup>2</sup>          | in <sup>2</sup>          | cm <sup>2</sup>          | in <sup>2</sup>          | cm <sup>2</sup>          | in <sup>2</sup>          | cm <sup>2</sup>          | in <sup>2</sup>          | cm <sup>2</sup>          | in <sup>2</sup>          | cm <sup>2</sup>          | in <sup>2</sup>          |                          |
| Contact area *) | 3520                   | 545,56                   | 4160                     | 644,76                   | 4370                     | 677,31                   | 3200                     | 495,97                   | 4030                     | 624,61                   | 4830                     | 748,6                    | 4830                     | 748,6                    | 4760                     | 737,75                   |                          |
| <b>Load</b>     | <b>Ground pressure</b> |                          | <b>Ground pressure</b>   |                          | <b>Ground pressure</b>   |                          | <b>Ground pressure</b>   |                          | <b>Ground pressure</b>   |                          | <b>Ground pressure</b>   |                          | <b>Ground pressure</b>   |                          | <b>Ground pressure</b>   |                          |                          |
| <b>kg</b>       | <b>lb</b>              | <b>kg/cm<sup>2</sup></b> | <b>lb/in<sup>2</sup></b> | <b>kg/cm<sup>2</sup></b> | <b>lb/in<sup>2</sup></b> | <b>kg/cm<sup>2</sup></b> | <b>lb/in<sup>2</sup></b> | <b>kg/cm<sup>2</sup></b> | <b>lb/in<sup>2</sup></b> | <b>kg/cm<sup>2</sup></b> | <b>lb/in<sup>2</sup></b> | <b>kg/cm<sup>2</sup></b> | <b>lb/in<sup>2</sup></b> | <b>kg/cm<sup>2</sup></b> | <b>lb/in<sup>2</sup></b> | <b>kg/cm<sup>2</sup></b> | <b>lb/in<sup>2</sup></b> |
| 500             | 1100                   | 0,14                     | 2,02                     | 0,12                     | 1,71                     | 0,11                     | 1,62                     | 0,16                     | 2,22                     | 0,12                     | 1,76                     | 0,10                     | 1,47                     | 0,10                     | 1,47                     | 0,11                     | 1,49                     |
| 1000            | 2205                   | 0,28                     | 4,04                     | 0,24                     | 3,42                     | 0,23                     | 3,26                     | 0,31                     | 4,45                     | 0,25                     | 3,53                     | 0,21                     | 2,95                     | 0,21                     | 2,95                     | 0,21                     | 2,99                     |
| 1500            | 3305                   | 0,43                     | 6,06                     | 0,36                     | 5,13                     | 0,34                     | 4,88                     | 0,47                     | 6,66                     | 0,37                     | 5,29                     | 0,31                     | 4,41                     | 0,31                     | 4,41                     | 0,32                     | 4,48                     |

|       |       |      |       |      |       |      |       |      |       |      |       |      |       |      |       |      |       |
|-------|-------|------|-------|------|-------|------|-------|------|-------|------|-------|------|-------|------|-------|------|-------|
| 2000  | 4410  | 0,57 | 8,08  | 0,48 | 6,84  | 0,46 | 6,51  | 0,63 | 8,89  | 0,50 | 7,06  | 0,41 | 5,89  | 0,41 | 5,89  | 0,42 | 5,98  |
| 2500  | 5510  | 0,71 | 10,10 | 0,60 | 8,55  | 0,57 | 8,14  | 0,78 | 11,11 | 0,62 | 8,82  | 0,52 | 7,36  | 0,52 | 7,36  | 0,53 | 7,47  |
| 3000  | 6615  | 0,85 | 12,13 | 0,72 | 10,26 | 0,69 | 9,77  | 0,94 | 13,34 | 0,74 | 10,59 | 0,62 | 8,84  | 0,62 | 8,84  | 0,63 | 8,97  |
| 3500  | 7715  | 0,99 | 14,14 | 0,84 | 11,97 | 0,80 | 11,39 | 1,09 | 15,56 | 0,87 | 12,35 | 0,72 | 10,31 | 0,72 | 10,31 | 0,74 | 10,46 |
| 4000  | 8820  | 1,14 | 16,17 | 0,96 | 13,68 | 0,92 | 13,02 | 1,25 | 17,78 | 0,99 | 14,12 | 0,83 | 11,78 | 0,83 | 11,78 | 0,84 | 11,96 |
| 4500  | 9920  | 1,28 | 18,18 | 1,08 | 15,39 | 1,03 | 14,65 |      |       | 1,12 | 15,88 | 0,93 | 13,25 | 0,93 | 13,25 | 0,95 | 13,45 |
| 5000  | 11025 | 1,42 | 20,21 |      |       | 1,14 | 16,28 |      |       | 1,24 | 17,65 | 1,04 | 14,73 | 1,04 | 14,73 | 1,05 | 14,94 |
| 5500  | 12125 | 1,56 | 22,22 |      |       | 1,26 | 17,90 |      |       | 1,36 | 19,41 | 1,14 | 16,20 | 1,14 | 16,20 | 1,16 | 16,44 |
| 6000  | 13230 |      |       |      |       | 1,37 | 19,53 |      |       | 1,49 | 21,18 | 1,24 | 17,67 | 1,24 | 17,67 | 1,26 | 17,93 |
| 6500  | 14330 |      |       |      |       |      |       |      |       | 1,61 | 22,94 | 1,35 | 19,14 | 1,35 | 19,14 | 1,37 | 19,42 |
| 7000  | 15430 |      |       |      |       |      |       |      |       |      |       | 1,45 | 20,61 | 1,45 | 20,61 | 1,47 | 20,91 |
| 7500  | 16535 |      |       |      |       |      |       |      |       |      |       | 1,55 | 22,09 | 1,55 | 22,09 | 1,58 | 22,41 |
| 8000  | 17635 |      |       |      |       |      |       |      |       |      |       | 1,66 | 23,56 | 1,66 | 23,56 |      |       |
| 8500  | 18740 |      |       |      |       |      |       |      |       |      |       |      |       | 1,76 | 25,03 |      |       |
| 9000  | 19840 |      |       |      |       |      |       |      |       |      |       |      |       |      |       |      |       |
| 9500  | 20945 |      |       |      |       |      |       |      |       |      |       |      |       |      |       |      |       |
| 10000 | 22045 |      |       |      |       |      |       |      |       |      |       |      |       |      |       |      |       |

\*) CONTACT AREA CALCULATED BY USING A FORMULA BY THE SWEDISH FORESTRY RESEARCH INSTITUTE (SKOGSARBETEN).

**CONTACT AREA AND GROUND PRESSURE AT DIFFERENT TYRE LOADS. SOFT SOIL.**

|                 | 750/55-26.5 |      | 780/55-26.5 |      | 800/50R26.5 |      | 710/55-28.5 |      | 780/50-28.5 |      | 800/40-26.5 |      | 600/65-34 |      | 700/55-34 |      | 700/70-34 |      |
|-----------------|-------------|------|-------------|------|-------------|------|-------------|------|-------------|------|-------------|------|-----------|------|-----------|------|-----------|------|
|                 | mm          | in   | mm          | in   | mm          | in   | mm          | in   | mm          | in   | mm          | in   | mm        | in   | mm        | in   | mm        | in   |
| <b>Diameter</b> | 1485        | 58,5 | 1485        | 58,5 | 1485        | 58,5 | 1525        | 60,0 | 1525        | 60,0 | 1340        | 52,8 | 1644      | 64,7 | 1485      | 58,5 | 1844      | 72,6 |

| Width                      |       | 750                | 29,5               | 780                | 30,7               | 800                | 31,5               | 710                | 28,0               | 780                | 30,7               | 800                | 31,5               | 600                | 23,6               | 700                | 27,6               | 700                | 27,6               |
|----------------------------|-------|--------------------|--------------------|--------------------|--------------------|--------------------|--------------------|--------------------|--------------------|--------------------|--------------------|--------------------|--------------------|--------------------|--------------------|--------------------|--------------------|--------------------|--------------------|
|                            |       | cm <sup>2</sup>    | in <sup>2</sup>    | cm <sup>2</sup>    | in <sup>2</sup>    | cm <sup>2</sup>    | in <sup>2</sup>    | cm <sup>2</sup>    | in <sup>2</sup>    | cm <sup>2</sup>    | in <sup>2</sup>    | cm <sup>2</sup>    | in <sup>2</sup>    | cm <sup>2</sup>    | in <sup>2</sup>    | cm <sup>2</sup>    | in <sup>2</sup>    | cm <sup>2</sup>    | in <sup>2</sup>    |
| Contact area <sup>1)</sup> |       | 5570               | 863,29             | 5790               | 897,39             | 5940               | 920,64             | 5410               | 838,5              | 5950               | 922,191            | 5360               | 830,75             | 4930               | 764,101            | 5200               | 805,948            | 6450               | 999,686            |
| Load                       |       | Ground pressure    |                    | Ground pressure    |                    | Ground pressure    |                    | Ground pressure    |                    | Ground pressure    |                    | Ground pressure    |                    | Ground pressure    |                    | Ground pressure    |                    | Ground pressure    |                    |
| kg                         | lb    | kg/cm <sup>2</sup> | lb/in <sup>2</sup> | kg/cm <sup>2</sup> | lb/in <sup>2</sup> | kg/cm <sup>2</sup> | lb/in <sup>2</sup> | kg/cm <sup>2</sup> | lb/in <sup>2</sup> | kg/cm <sup>2</sup> | lb/in <sup>2</sup> | kg/cm <sup>2</sup> | lb/in <sup>2</sup> | kg/cm <sup>2</sup> | lb/in <sup>2</sup> | kg/cm <sup>2</sup> | lb/in <sup>2</sup> | kg/cm <sup>2</sup> | lb/in <sup>2</sup> |
| 500                        | 1100  | 0,09               | 1,27               | 0,09               | 1,23               | 0,08               | 1,19               | 0,09               | 1,31               | 0,08               | 1,19               | 0,09               | 1,32               | 0,10               | 1,44               | 0,10               | 1,36               | 0,08               | 1,10               |
| 1000                       | 2205  | 0,18               | 2,55               | 0,17               | 2,46               | 0,17               | 2,40               | 0,18               | 2,63               | 0,17               | 2,39               | 0,19               | 2,65               | 0,20               | 2,89               | 0,19               | 2,74               | 0,16               | 2,21               |
| 1500                       | 3305  | 0,27               | 3,83               | 0,26               | 3,68               | 0,25               | 3,59               | 0,28               | 3,94               | 0,25               | 3,58               | 0,28               | 3,98               | 0,30               | 4,33               | 0,29               | 4,10               | 0,23               | 3,31               |
| 2000                       | 4410  | 0,36               | 5,11               | 0,35               | 4,91               | 0,34               | 4,79               | 0,37               | 5,26               | 0,34               | 4,78               | 0,37               | 5,31               | 0,41               | 5,77               | 0,38               | 5,47               | 0,31               | 4,41               |
| 2500                       | 5510  | 0,45               | 6,38               | 0,43               | 6,14               | 0,42               | 5,98               | 0,46               | 6,57               | 0,42               | 5,97               | 0,47               | 6,63               | 0,51               | 7,21               | 0,48               | 6,84               | 0,39               | 5,51               |
| 3000                       | 6615  | 0,54               | 7,66               | 0,52               | 7,37               | 0,51               | 7,19               | 0,55               | 7,89               | 0,50               | 7,17               | 0,56               | 7,96               | 0,61               | 8,66               | 0,58               | 8,21               | 0,47               | 6,62               |
| 3500                       | 7715  | 0,63               | 8,94               | 0,60               | 8,60               | 0,59               | 8,38               | 0,65               | 9,20               | 0,59               | 8,37               | 0,65               | 9,29               | 0,71               | 10,10              | 0,67               | 9,57               | 0,54               | 7,72               |
| 4000                       | 8820  | 0,72               | 10,22              | 0,69               | 9,83               | 0,67               | 9,58               | 0,74               | 10,52              | 0,67               | 9,56               | 0,75               | 10,62              | 0,81               | 11,54              | 0,77               | 10,94              | 0,62               | 8,82               |
| 4500                       | 9920  | 0,81               | 11,49              | 0,78               | 11,05              | 0,76               | 10,78              | 0,83               | 11,83              | 0,76               | 10,76              | 0,84               | 11,94              | 0,91               | 12,98              | 0,87               | 12,31              | 0,70               | 9,92               |
| 5000                       | 11025 | 0,90               | 12,77              | 0,86               | 12,29              | 0,84               | 11,98              | 0,92               | 13,15              | 0,84               | 11,96              | 0,93               | 13,27              | 1,01               | 14,43              | 0,96               | 13,68              | 0,78               | 11,03              |
| 5500                       | 12125 | 0,99               | 14,05              | 0,95               | 13,51              | 0,93               | 13,17              | 1,02               | 14,46              | 0,92               | 13,15              | 1,03               | 14,60              |                    |                    | 1,06               | 15,04              | 0,85               | 12,13              |
| 6000                       | 13230 | 1,08               | 15,33              | 1,04               | 14,74              | 1,01               | 14,37              | 1,11               | 15,78              | 1,01               | 14,35              | 1,12               | 15,93              |                    |                    | 1,15               | 16,42              | 0,93               | 13,23              |
| 6500                       | 14330 | 1,17               | 16,60              | 1,12               | 15,97              | 1,09               | 15,57              | 1,20               | 17,09              | 1,09               | 15,54              | 1,21               | 17,25              |                    |                    |                    |                    | 1,01               | 14,33              |
| 7000                       | 15430 | 1,26               | 17,87              | 1,21               | 17,19              | 1,18               | 16,76              | 1,29               | 18,40              | 1,18               | 16,73              |                    |                    |                    |                    |                    |                    | 1,09               | 15,43              |
| 7500                       | 16535 | 1,35               | 19,15              | 1,30               | 18,43              | 1,26               | 17,96              | 1,39               | 19,72              | 1,26               | 17,93              |                    |                    |                    |                    |                    |                    |                    |                    |
| 8000                       | 17635 | 1,44               | 20,43              | 1,38               | 19,65              | 1,35               | 19,16              | 1,48               | 21,03              | 1,34               | 19,12              |                    |                    |                    |                    |                    |                    |                    |                    |
| 8500                       | 18740 | 1,53               | 21,71              | 1,47               | 20,88              | 1,43               | 20,36              | 1,57               | 22,35              | 1,43               | 20,32              |                    |                    |                    |                    |                    |                    |                    |                    |
| 9000                       | 19840 | 1,62               | 22,98              | 1,55               | 22,11              | 1,52               | 21,55              | 1,66               | 23,66              | 1,51               | 21,51              |                    |                    |                    |                    |                    |                    |                    |                    |

|       |       |      |       |      |       |      |       |      |       |      |       |  |  |  |  |  |  |  |
|-------|-------|------|-------|------|-------|------|-------|------|-------|------|-------|--|--|--|--|--|--|--|
| 9500  | 20945 | 1,71 | 24,26 | 1,64 | 23,34 | 1,60 | 22,75 | 1,76 | 24,98 | 1,60 | 22,71 |  |  |  |  |  |  |  |
| 10000 | 22045 | 1,80 | 25,54 | 1,73 | 24,57 | 1,68 | 23,95 | 1,85 | 26,29 | 1,68 | 23,91 |  |  |  |  |  |  |  |

\*) CONTACT AREA CALCULATED BY USING A FORMULA BY THE SWEDISH FORESTRY RESEARCH INSTITUTE (SKOGSARBETEN).

**CONTACT AREA AND GROUND PRESSURE AT DIFFERENT TYRE LOADS. SOFT SOIL.**

|                        |      | 23.1-26            |                    | 28L-26             |                    | 30.5L-32           |                    | 620/75-26          |                    | 500/70-28          |                    | 540/70-30          |                    | 600/70-38          |                    | 650/75-38          |                    |
|------------------------|------|--------------------|--------------------|--------------------|--------------------|--------------------|--------------------|--------------------|--------------------|--------------------|--------------------|--------------------|--------------------|--------------------|--------------------|--------------------|--------------------|
|                        |      | mm                 | in                 | mm                 | in                 | mm                 | in                 | mm                 | in                 | mm                 | in                 | mm                 | in                 | mm                 | in                 | mm                 | in                 |
| <b>Diameter</b>        |      | 1632               | 64,3               | 1644               | 64,7               | 1857               | 73,1               | 1590               | 62,6               | 1405               | 55,3               | 1515               | 59,6               | 1820               | 71,7               | 1965               | 77,4               |
| <b>Width</b>           |      | 587                | 23,1               | 714                | 28,1               | 775                | 30,5               | 625                | 24,6               | 503                | 19,8               | 540                | 21,3               | 611                | 24,1               | 650                | 25,6               |
|                        |      | cm <sup>2</sup>    | in <sup>2</sup>    | cm <sup>2</sup>    | in <sup>2</sup>    | cm <sup>2</sup>    | in <sup>2</sup>    | cm <sup>2</sup>    | in <sup>2</sup>    | cm <sup>2</sup>    | in <sup>2</sup>    | cm <sup>2</sup>    | in <sup>2</sup>    | cm <sup>2</sup>    | in <sup>2</sup>    | cm <sup>2</sup>    | in <sup>2</sup>    |
| <b>Contact area *)</b> |      | 4790               | 742,4              | 5870               | 909,79             | 7200               | 1115,9             | 4970               | 770,3              | 3530               | 547,11             | 4090               | 633,91             | 5560               | 861,74             | 6390               | 990,39             |
| <b>Load</b>            |      | Ground pressure    |                    | Ground pressure    |                    | Ground pressure    |                    | Ground pressure    |                    | Ground pressure    |                    | Ground pressure    |                    | Ground pressure    |                    | Ground pressure    |                    |
| kg                     | lb   | kg/cm <sup>2</sup> | lb/in <sup>2</sup> | kg/cm <sup>2</sup> | lb/in <sup>2</sup> | kg/cm <sup>2</sup> | lb/in <sup>2</sup> | kg/cm <sup>2</sup> | lb/in <sup>2</sup> | kg/cm <sup>2</sup> | lb/in <sup>2</sup> | kg/cm <sup>2</sup> | lb/in <sup>2</sup> | kg/cm <sup>2</sup> | lb/in <sup>2</sup> | kg/cm <sup>2</sup> | lb/in <sup>2</sup> |
| 500                    | 1100 | 0,10               | 1,48               | 0,09               | 1,21               | 0,07               | 0,99               | 0,10               | 1,43               | 0,14               | 2,01               | 0,12               | 1,74               | 0,09               | 1,28               | 0,08               | 1,11               |
| 1000                   | 2205 | 0,21               | 2,97               | 0,17               | 2,42               | 0,14               | 1,98               | 0,20               | 2,86               | 0,28               | 4,03               | 0,24               | 3,48               | 0,18               | 2,56               | 0,16               | 2,23               |
| 1500                   | 3305 | 0,31               | 4,45               | 0,26               | 3,63               | 0,21               | 2,96               | 0,30               | 4,29               | 0,42               | 6,04               | 0,37               | 5,21               | 0,27               | 3,84               | 0,23               | 3,34               |
| 2000                   | 4410 | 0,42               | 5,94               | 0,34               | 4,85               | 0,28               | 3,95               | 0,40               | 5,73               | 0,57               | 8,06               | 0,49               | 6,96               | 0,36               | 5,12               | 0,31               | 4,45               |
| 2500                   | 5510 | 0,52               | 7,42               | 0,43               | 6,06               | 0,35               | 4,94               | 0,50               | 7,15               | 0,71               | 10,07              | 0,61               | 8,69               | 0,45               | 6,39               | 0,39               | 5,56               |
| 3000                   | 6615 | 0,63               | 8,91               | 0,51               | 7,27               | 0,42               | 5,93               | 0,60               | 8,59               | 0,85               | 12,09              | 0,73               | 10,44              | 0,54               | 7,68               | 0,47               | 6,68               |
| 3500                   | 7715 | 0,73               | 10,39              | 0,60               | 8,48               | 0,49               | 6,91               | 0,70               | 10,02              | 0,99               | 14,10              | 0,86               | 12,17              | 0,63               | 8,95               | 0,55               | 7,79               |
| 4000                   | 8820 | 0,84               | 11,88              | 0,68               | 9,69               | 0,56               | 7,90               | 0,80               | 11,45              | 1,13               | 16,12              | 0,98               | 13,91              | 0,72               | 10,24              | 0,63               | 8,91               |
| 4500                   | 9920 | 0,94               | 13,36              | 0,77               | 10,90              | 0,63               | 8,89               | 0,91               | 12,88              |                    |                    | 1,10               | 15,65              | 0,81               | 11,51              | 0,70               | 10,02              |

|      |       |      |       |      |       |      |       |      |       |  |  |  |  |      |       |      |       |
|------|-------|------|-------|------|-------|------|-------|------|-------|--|--|--|--|------|-------|------|-------|
| 5000 | 11025 | 1,04 | 14,85 | 0,85 | 12,12 | 0,69 | 9,88  | 1,01 | 14,31 |  |  |  |  | 0,90 | 12,79 | 0,78 | 11,13 |
| 5500 | 12125 | 1,15 | 16,33 | 0,94 | 13,33 | 0,76 | 10,87 | 1,11 | 15,74 |  |  |  |  | 0,99 | 14,07 | 0,86 | 12,24 |
| 6000 | 13230 | 1,25 | 17,82 | 1,02 | 14,54 | 0,83 | 11,86 |      |       |  |  |  |  | 1,08 | 15,35 | 0,94 | 13,36 |
| 6500 | 14330 |      |       |      |       | 0,90 | 12,84 |      |       |  |  |  |  | 1,17 | 16,63 | 1,02 | 14,47 |
| 7000 | 15430 |      |       |      |       | 0,97 | 13,83 |      |       |  |  |  |  |      |       | 1,10 | 15,58 |
| 7500 | 16535 |      |       |      |       | 1,04 | 14,82 |      |       |  |  |  |  |      |       |      |       |
| 8000 | 17635 |      |       |      |       | 1,11 | 15,80 |      |       |  |  |  |  |      |       |      |       |
| 8500 | 18740 |      |       |      |       |      |       |      |       |  |  |  |  |      |       |      |       |
| 9000 | 19840 |      |       |      |       |      |       |      |       |  |  |  |  |      |       |      |       |
| 9500 | 20945 |      |       |      |       |      |       |      |       |  |  |  |  |      |       |      |       |

**\*) CONTACT AREA CALCULATED BY USING A FORMULA BY THE SWEDISH FORESTRY RESEARCH INSTITUTE (SKOGSARBETEN).**

**CONTACT AREA AND GROUND PRESSURE AT DIFFERENT TYRE LOADS. SOFT SOIL.**

|                        |           | 16.9-28                  |                          | 16.9-30                  |                          | 16.9-34                  |                          | 18.4-34                  |                          | 18.4-38                  |                          | 20.8-38                  |                          |
|------------------------|-----------|--------------------------|--------------------------|--------------------------|--------------------------|--------------------------|--------------------------|--------------------------|--------------------------|--------------------------|--------------------------|--------------------------|--------------------------|
|                        |           | mm                       | in                       | mm                       | in                       | mm                       | in                       | mm                       | in                       | mm                       | in                       | mm                       | in                       |
| <b>Diameter</b>        |           | 1435                     | 56,5                     | 1485                     | 58,5                     | 1585                     | 62,4                     | 1650                     | 65,0                     | 1750                     | 68,9                     | 1840                     | 72,4                     |
| <b>Width</b>           |           | 429                      | 16,9                     | 429                      | 16,9                     | 429                      | 16,9                     | 467                      | 18,4                     | 467                      | 18,4                     | 528                      | 20,8                     |
|                        |           | cm <sup>2</sup>          | in <sup>2</sup>          | cm <sup>2</sup>          | in <sup>2</sup>          | cm <sup>2</sup>          | in <sup>2</sup>          | cm <sup>2</sup>          | in <sup>2</sup>          | cm <sup>2</sup>          | in <sup>2</sup>          | cm <sup>2</sup>          | in <sup>2</sup>          |
| <b>Contact area *)</b> |           | 3080                     | 477,37                   | 3190                     | 494,42                   | 3400                     | 526,97                   | 3850                     | 596,71                   | 4090                     | 633,909                  | 4860                     | 753,25                   |
| <b>Load</b>            |           | <b>Ground pressure</b>   |                          | <b>Ground pressure</b>   |                          | <b>Ground pressure</b>   |                          | <b>Ground pressure</b>   |                          | <b>Ground pressure</b>   |                          | <b>Ground pressure</b>   |                          |
| <b>kg</b>              | <b>lb</b> | <b>kg/cm<sup>2</sup></b> | <b>lb/in<sup>2</sup></b> | <b>kg/cm<sup>2</sup></b> | <b>lb/in<sup>2</sup></b> | <b>kg/cm<sup>2</sup></b> | <b>lb/in<sup>2</sup></b> | <b>kg/cm<sup>2</sup></b> | <b>lb/in<sup>2</sup></b> | <b>kg/cm<sup>2</sup></b> | <b>lb/in<sup>2</sup></b> | <b>kg/cm<sup>2</sup></b> | <b>lb/in<sup>2</sup></b> |
| 500                    | 1100      | 0,16                     | 2,30                     | 0,16                     | 2,22                     | 0,15                     | 2,09                     | 0,13                     | 1,84                     | 0,12                     | 1,74                     | 0,10                     | 1,46                     |
| 1000                   | 2205      | 0,32                     | 4,62                     | 0,31                     | 4,46                     | 0,29                     | 4,18                     | 0,26                     | 3,70                     | 0,24                     | 3,48                     | 0,21                     | 2,93                     |

|      |       |      |       |      |       |      |       |      |       |      |       |      |       |
|------|-------|------|-------|------|-------|------|-------|------|-------|------|-------|------|-------|
| 1500 | 3305  | 0,49 | 6,92  | 0,47 | 6,68  | 0,44 | 6,27  | 0,39 | 5,54  | 0,37 | 5,21  | 0,31 | 4,39  |
| 2000 | 4410  | 0,65 | 9,24  | 0,63 | 8,92  | 0,59 | 8,37  | 0,52 | 7,39  | 0,49 | 6,96  | 0,41 | 5,85  |
| 2500 | 5510  | 0,81 | 11,54 | 0,78 | 11,14 | 0,74 | 10,46 | 0,65 | 9,23  | 0,61 | 8,69  | 0,51 | 7,31  |
| 3000 | 6615  | 0,97 | 13,86 | 0,94 | 13,38 | 0,88 | 12,55 | 0,78 | 11,09 | 0,73 | 10,44 | 0,62 | 8,78  |
| 3500 | 7715  | 1,14 | 16,16 | 1,10 | 15,60 | 1,03 | 14,64 | 0,91 | 12,93 | 0,86 | 12,17 | 0,72 | 10,24 |
| 4000 | 8820  |      |       |      |       | 1,18 | 16,74 | 1,04 | 14,78 | 0,98 | 13,91 | 0,82 | 11,71 |
| 4500 | 9920  |      |       |      |       |      |       | 1,17 | 16,62 | 1,10 | 15,65 | 0,93 | 13,17 |
| 5000 | 11025 |      |       |      |       |      |       |      |       |      |       | 1,03 | 14,64 |
| 5500 | 12125 |      |       |      |       |      |       |      |       |      |       | 1,13 | 16,10 |
| 6000 | 13230 |      |       |      |       |      |       |      |       |      |       |      |       |
| 6500 | 14330 |      |       |      |       |      |       |      |       |      |       |      |       |
| 7000 | 15430 |      |       |      |       |      |       |      |       |      |       |      |       |
| 7500 | 16535 |      |       |      |       |      |       |      |       |      |       |      |       |
| 8000 | 17635 |      |       |      |       |      |       |      |       |      |       |      |       |
| 8500 | 18740 |      |       |      |       |      |       |      |       |      |       |      |       |
| 9000 | 19840 |      |       |      |       |      |       |      |       |      |       |      |       |
| 9500 | 20945 |      |       |      |       |      |       |      |       |      |       |      |       |

**\*) CONTACT AREA CALCULATED BY USING A FORMULA BY THE SWEDISH FORESTRY RESEARCH INSTITUTE (SKOGSARBETEN).**

# CONTACT AREAS ON A HARD DRIVING SURFACE

TRI patterns have a significantly larger net contact area compared with traditional tractor drive tires. This results in significant improvement in friction rate, grip, and wear rate.

## GROUND CONTACT AREA RATIOS

**NORMAL TRACTOR  
DRIVE TIRE**

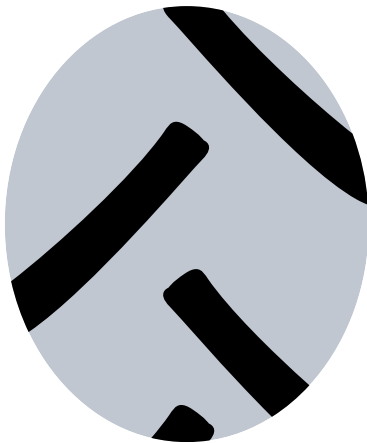

20-25 % net contact area

**NORMAL SECTION  
TRI**



42 % net contact area

**80 SERIES  
TRI 2**

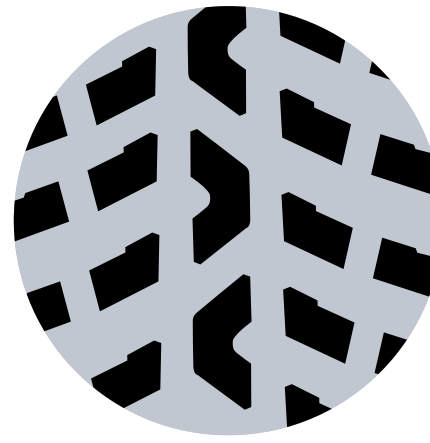

39% net contact area

**80 SERIES  
HAKKAPELIITTA TRI**

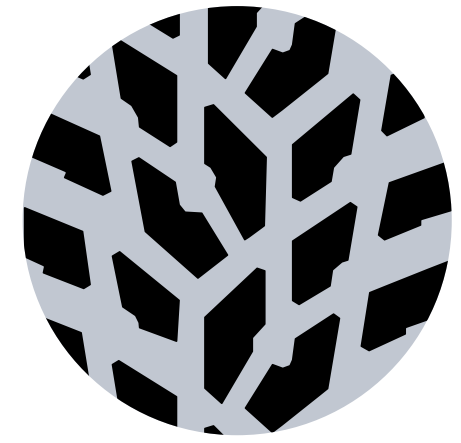

45 % net contact area

## CONTACT AREA ON HARD SURFACE

The deflection takes place only on the tire and not at all on the ground. The values in the table are valid at the nominal load and air pressure conditions.

## CONTACT AREA ON SOFT SOIL

The deflection takes place mainly on the ground: the tire sinks 15% of its diameter into ground, but the deflection will recover to half of the original value. It is impossible to compare actual measurements in different places, but comparison between different tire sizes is possible with the help of the table below.

Compared to the corresponding standard dimension TRI 2 tire commonly gives an appr. 5–10% larger contact area.

65 series tires will give an approximately 20–30% larger area compared to corresponding sizes with a normal section.

## NOKIAN TYRES TRI 2

| Size             | Contact area    |                 |                 |                 |
|------------------|-----------------|-----------------|-----------------|-----------------|
|                  | Hard surface    |                 | Soft surface    |                 |
|                  | cm <sup>2</sup> | in <sup>2</sup> | cm <sup>2</sup> | in <sup>2</sup> |
| <b>85-series</b> |                 |                 |                 |                 |
| 320/85R28        | 806             | 125             | 1 994           | 309             |
| <b>80-series</b> |                 |                 |                 |                 |
| 250/80R16        | 376             | 58              | 1 091           | 169             |
| 340/80R18        | 711             | 110             | 1 717           | 266             |
| 360/80R20        | 810             | 126             | 1 950           | 302             |
| 300/80R24        | 674             | 104             | 1 608           | 249             |
| 340/80R24        | 755             | 117             | 1 980           | 307             |
| 360/80R24        | 458             | 131             | 2 115           | 328             |
| 400/80R24        | 1 035           | 160             | 2 525           | 391             |
| 440/80R24        | 1 200           | 186             | 2 895           | 449             |
| 360/80R28        | 947             | 147             | 2 324           | 360             |
| 400/80R28        | 1 065           | 165             | 2 730           | 423             |
| 440/80R28        | 1 270           | 197             | 3 120           | 484             |
| 440/80R30        | 1 290           | 200             | 3 230           | 501             |
| 480/80R30        | 1 515           | 235             | 3 665           | 568             |
| 440/80R34        | 1 375           | 213             | 3 445           | 535             |
| 480/80R34        | 1 590           | 246             | 3 910           | 606             |
| 480/80R38        | 1 645           | 255             | 4 150           | 643             |
| 540/80R38        | 2 030           | 315             | 5 030           | 780             |
| 620/80R42        | 2 743           | 425             | 6 434           | 997             |
| <b>75-series</b> |                 |                 |                 |                 |
| 270/75R15        | 371             | 58              | 1 086           | 168             |
| 250/75R16        | 323             | 50              | 1 009           | 156             |
| <b>70-series</b> |                 |                 |                 |                 |

| Size             | Contact area    |                 |                 |                 |
|------------------|-----------------|-----------------|-----------------|-----------------|
|                  | Hard surface    |                 | Soft surface    |                 |
|                  | cm <sup>2</sup> | in <sup>2</sup> | cm <sup>2</sup> | in <sup>2</sup> |
| 360/70R20        | 735             | 114             | 1 835           | 284             |
| 500/70R24        | 1 523           | 236             | 3 608           | 559             |
| <b>65-series</b> |                 |                 |                 |                 |
| 420/65R24        | 960             | 149             | 2 415           | 374             |
| 460/65R24        | 1 178           | 183             | 2 742           | 425             |
| 540/65R24        | 1 523           | 236             | 3 608           | 559             |
| 480/65R28        | 1 352           | 210             | 3 086           | 478             |
| 540/65R28        | 1 639           | 254             | 3 740           | 580             |
| 540/65R30        | 1 698           | 263             | 3 867           | 599             |
| 600/65R38        | 2 239           | 347             | 4 976           | 771             |
| 650/65R38        | 2 524           | 391             | 5 657           | 877             |
| 650/65R42        | 2 666           | 413             | 5 953           | 923             |

## NOKIAN TYRES TRI

| Size               | Contact area    |                 |                 |                 |
|--------------------|-----------------|-----------------|-----------------|-----------------|
|                    | Hard surface    |                 | Soft surface    |                 |
|                    | cm <sup>2</sup> | in <sup>2</sup> | cm <sup>2</sup> | in <sup>2</sup> |
| 11.2R24            | 530             | 82              | 1 530           | 237             |
| 16.9R24            | 1 130           | 175             | 2 810           | 436             |
| 16.9R30            | 1 180           | 183             | 3 130           | 485             |
| 18.4R30            | 1 440           | 223             | 3 570           | 533             |
| <b>65-series</b>   |                 |                 |                 |                 |
| 420/65R24          | 940             | 146             | 2 370           | 367             |
| 460/65R24          | 1 040           | 161             | 2 650           | 411             |
| 480/65R24          | 1 150           | 178             | 2 910           | 451             |
| 520/65R24          | 1 430           | 222             | 3 410           | 529             |
| 480/65R28          | 1 145           | 177             | 3 070           | 476             |
| 600/65R38          | 2 110           | 327             | 5 020           | 778             |
| <b>Bias Beltet</b> |                 |                 |                 |                 |
| 18.4B30            | 1 440           | 223             | 3 575           | 544             |
| 580/65B30          | 1 870           | 290             | 4 440           | 688             |
| 580/65B34          | 1 990           | 308             | 4 730           | 733             |

# STUDS AND CHAINS

## STUDS

Nokian Tyres TRI 2, Nokian Tyres TRI, Nokian Tyres Hakkapeliitta Loader and Nokian Tyres Loader Grip patterns offer an excellent winter grip. To gain even more traction and grip in extreme wet icy conditions the tires can be studded. The following schematic pictures show the studding sequence.

## STUD RECOMMENDATION

- Recommended types are truck, tractor or construction machine studs
- Maximum stud length is 25 mm / 1 in
- Minimum stud flange is 9 mm / 11/32 in

## STUD DIMENSIONING EXAMPLES

| Stud marking | Stud length |       | Flange diameter |       | Stud hole diameter |      | Stud protusion |      |
|--------------|-------------|-------|-----------------|-------|--------------------|------|----------------|------|
|              | mm          | in    | mm              | in    | mm                 | in   | mm             | in   |
| 9 - 15       | 15          | 19/32 | 9               | 11/32 | 4                  | 5/32 | 2              | 3/32 |
| 11 - 15      | 15          | 19/32 | 11              | 14/32 | 5                  | 6/32 | 2              | 3/32 |
| 11 - 17      | 17          | 21/32 | 11              | 14/32 | 5                  | 6/32 | 2.5            | 3/32 |
| 12 - 17      | 17          | 21/32 | 12              | 15/32 | 5                  | 6/32 | 2.5            | 3/32 |
| 12 - 20      | 20          | 25/32 | 12              | 15/32 | 5                  | 6/32 | 3              | 4/32 |
| 12 - 24      | 24          | 30/32 | 12              | 15/32 | 6                  | 8/32 | 3              | 4/32 |
| 16 - 19      | 19          | 24/32 | 16              | 20/32 | 7                  | 9/32 | 2.5            | 3/32 |

**NOKIAN TYRES HAKKAPELIITTA TRI**

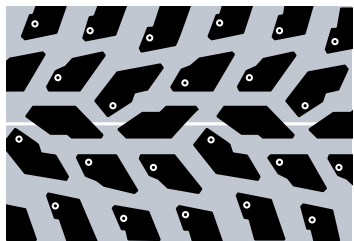

Stud places marked

**NOKIAN TYRES TRI 65 SERIES**

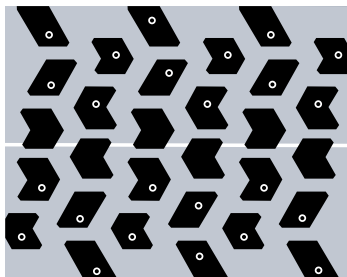

**NOKIAN TYRES TRI**

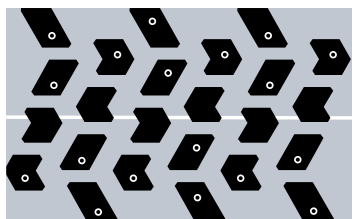

**NOKIAN TYRES GROUND KING**



**NOKIAN TYRES TRI 2**

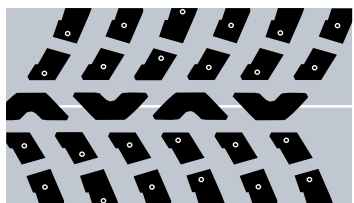

**NOKIAN TYRES HAKKAPELIITTA LOADER**

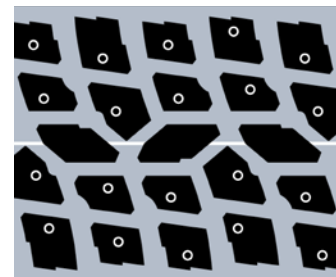

**NOKIAN TYRES LOADER GRIP**

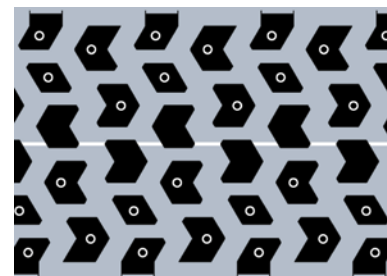

**NUMBER OF STUDS - NOKIAN TYRES TRI 2**

| Size             | Pattern | Number of studs |
|------------------|---------|-----------------|
| <b>85-series</b> |         |                 |
| 320/85R28        | TRI 2   | 168             |
| <b>80-series</b> |         |                 |
| 250/80R16        | TRI 2   | 144             |
| 340/80R18        | TRI 2   | 144             |
| 360/80R20        | TRI 2   | 144             |
| 300/80R24        | TRI 2   | 168             |
| 340/80R24        | TRI 2   | 168             |
| 360/80R24        | TRI 2   | 168             |
| 400/80R24        | TRI 2   | 168             |
| 440/80R24        | TRI 2   | 168             |
| 360/80R28        | TRI 2   | 168             |
| 400/80R28        | TRI 2   | 168             |
| 440/80R28        | TRI 2   | 168             |
| 440/80R30        | TRI 2   | 168             |
| 480/80R30        | TRI 2   | 168             |
| 440/80R34        | TRI 2   | 192             |
| 480/80R34        | TRI 2   | 192             |
| 480/80R38        | TRI 2   | 192             |
| 540/80R38        | TRI 2   | 192             |
| 620/80R42        | TRI 2   | 192             |

| Size             | Pattern | Number of studs |
|------------------|---------|-----------------|
| <b>75-series</b> |         |                 |
| 270/75R15        | TRI 2   | 144             |
| 250/75R16        | TRI 2   | 144             |
| <b>70-series</b> |         |                 |
| 360/70R20        | TRI 2   | 144             |
| 500/70R24        | TRI 2   | 168             |
| 600/70R34        | TRI 2   | 192             |
| 710/70R42        | TRI 2   | 192             |
| <b>65-series</b> |         |                 |
| 420/65R24        | TRI 2   | 168             |
| 460/65R24        | TRI 2   | 168             |
| 540/65R24        | TRI 2   | 168             |
| 480/65R28        | TRI 2   | 168             |
| 540/65R28        | TRI 2   | 168             |
| 540/65R30        | TRI 2   | 168             |
| 600/65R34        | TRI 2   | 192             |
| 600/65R38        | TRI 2   | 192             |
| 650/65R38        | TRI 2   | 192             |
| 650/65R42        | TRI 2   | 192             |

**NUMBER OF STUDS - NOKIAN TYRES TRI**

| Size               | Pattern | Number of studs |
|--------------------|---------|-----------------|
| <b>65-series</b>   |         |                 |
| 460/65R24          | TRI     | 176             |
| 480/65R24          | TRI     | 184             |
| <b>Bias Beltet</b> |         |                 |
| 18.4B34            | TRI     | 144             |
| 580/65B30          | TRI     | 184             |
| 580/65B34          | TRI     | 192             |

## NUMBER OF STUDS - NOKIAN TYRES HAKKAPELIITTA TRI

| Size      | Number of studs | Max. stud flange diameter (mm) | Max. stud height (mm) |
|-----------|-----------------|--------------------------------|-----------------------|
| 400/60R18 | 120             | 9                              | 20                    |
| 340/80R18 | 120             | 9                              | 20                    |
| 360/80R20 | 144             | 9                              | 20                    |
| 400/70R20 | 168             | 9                              | 24                    |
| 420/65R24 | 168             | 9                              | 24                    |
| 360/80R24 | 168             | 9                              | 24                    |
| 400/80R24 | 168             | 9                              | 24                    |
| 440/80R24 | 168             | 9                              | 24                    |
| 460/70R24 | 144             | 12                             | 25                    |
| 500/70R24 | 144             | 12                             | 25                    |
| 540/70R24 | 144             | 12                             | 25                    |
| 400/80R28 | 168             | 9                              | 24                    |
| 440/80R28 | 168             | 12                             | 25                    |
| 540/65R28 | 168             | 12                             | 25                    |
| 540/65R30 | 168             | 12                             | 25                    |
| 440/80R34 | 192             | 12                             | 25                    |
| 480/80R34 | 192             | 12                             | 25                    |
| 600/70R32 | 192             | 12                             | 25                    |
| 480/80R38 | 192             | 12                             | 25                    |
| 540/80R38 | 192             | 12                             | 25                    |
| 650/65R38 | 192             | 12                             | 25                    |
| 650/65R42 | 192             | 12                             | 25                    |

## NUMBER OF STUDS - NOKIAN TYRES LOADER GRIP

| Size    | Number of studs |
|---------|-----------------|
| 17.5R25 | 180             |
| 20.5R25 | 180             |
| 23.5R25 | 172             |

## NUMBER OF STUDS - NOKIAN TYRES HAKKAPELIITTA LOADER

| Size     | Number of studs |
|----------|-----------------|
| 14.00R24 | 168             |
| 17.5R25  | 168             |
| 20.5R25  | 168             |
| 23.5R25  | 168             |

## CHAINS

It is recommended to use chains only for short periods at a time. Chains shorten the tire lifetime. Nokian Heavy Tyres limited warranty doesn't cover any damages made by accessories including the use of chains.

The use of chains comes into question when extreme conditions require additional grip. Then it is recommended to use chains only at low speeds and remove them when they are not needed anymore (i.e. road transit).

Before installing chains inspect them for sharp edges or welding burs.

Ensure that the chains are at the right tightness. Chains too loose can slip on the tire and cause excessive wear.

It is important to check that no chain rings are broken or that no individual rings have turned so that calks cut into the tire. Calks can cut into the tire also when chains are severely worn and over stretched.

# MPT AGILE STUD RECOMMENDATIONS

**1) NOKIAN TYRES MPT AGILE TIRES ARE PART OF THE TRUCK TIRE NORM. THEREFORE:**

Recommended stud for truck tires has a length of 15 mm / 19/32 nds of an inch and flange diameter of 11 mm / 14/32 nds of inch.

| Stud   |           |                 |           | Drilled stud hole |           |       |           |
|--------|-----------|-----------------|-----------|-------------------|-----------|-------|-----------|
| Length |           | Flange diameter |           | Diameter          |           | Depth |           |
| mm     | 32 nds in | mm              | 32 nds in | mm                | 32 nds in | mm    | 32 nds in |
| 15     | 19        | 11              | 14        | 5                 | 6         | 13    | 16        |

**2) STUD AMOUNT IN TIRES (EU / SINCE 1ST JULY 2009):**

Maximum of 50 pcs of studs allowed for every 1 m / 39,4 inch of tire circumference.

**WITH THE MPT AGILE PATTERN TYPE, THE AMOUNT OF STUDS:**

|                      |                                          |
|----------------------|------------------------------------------|
| 365/80R20 MPT Agile  | 171 pcs max (evenly distributed 168 pcs) |
| 14.00R20 MPT Agile   | 198 pcs max (evenly distributed 192 pcs) |
| 14 00R20 MPT Agile 2 | 198 pcs max (evenly distributed 182 pcs) |

**TRUCK TIRE STUD (MAX. 5 G / 0.18 OZ)**



**STUD PLACES IN MPT TIRES**

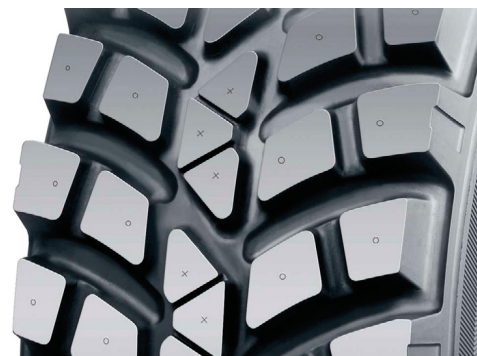

O = Normal stud places, 144 in total  
X = Additional stud places, 72 pcs

**Notice!** Please check your local legislation on stud use.

# MOUNTING TIRES ON FOUR WHEEL DRIVE TRACTORS

The mounting of tires on a four wheel drive tractor must be done with great care in order to produce the best driving results and maintain the tires' service life. Generally, the actual rolling circumference of a front tire should be 1–4 % higher than the rolling circumference calculated using the gear ratio. Excessive traction in the front tires can cause quick wear and reduce mileage, while insufficient traction in the front tires will make the tractor more difficult to steer. Check the manual of the tractor in question for detailed instructions on the calculation of rolling circumferences (gear ratio). When changing the tire size or type, always check the relationship between the rolling circumferences and make sure that the combination is within the limits given by the manufacturer.

## EXAMPLES OF THE CALCULATION

The basis for the calculation is the gear ratio between the front and rear axle, with which the rolling circumference of the required front tire can be calculated.

### EXAMPLE 1: CALCULATING THE ROLLING CIRCUMFERENCE OF FRONT TIRES

| Tire size   | Rolling circumference (from tire manufacturer) |
|-------------|------------------------------------------------|
| 16.9R28 TRI | 4222 mm                                        |
| 20.8R38 TRI | 5448 mm                                        |

Tractor gear ratio: 1.329. The target is 1–5% traction (lead) for front tires.

5448 mm (rear tire rolling circumference) / 1.329 (gear ratio) = 4099 mm (no traction)

|              |                          |
|--------------|--------------------------|
| 1% traction: | 1.01 x 4099 mm = 4140 mm |
| 5% traction: | 1.05 x 4099 mm = 4304 mm |

The selected tire 16.9R28 TRI has a rolling circumference (4140 mm < 4222 mm < 4303 mm) which is within the limit given by the manufacturer. The front tire's traction is 4222 / 4099 = 1.030, i.e. 3.0%.

### EXAMPLE 2: SWITCHING TO TRI 2 TIRES ON THE ABOVE MENTIONED MACHINE

Gear ratio: 1.329. The target is 1–5% traction for the front tire.

The control calculation must be verified. It must be noted as well that the TRI 2 and TRI tires have a different rolling circumference than a correspondent tire with a lug pattern.

| Tire size       | Rolling circumference (from tire manufacturer) |
|-----------------|------------------------------------------------|
| 440/80R28 TRI 2 | 4266 mm                                        |
| 540/80R38 TRI 2 | 5529 mm                                        |

#### Verification:

5529 mm (rear tire rolling circumference) / 1.329 (gear ratio) = 4160 mm (traction 0%)

|              |                          |
|--------------|--------------------------|
| 1% traction: | 1.01 x 4160 mm = 4202 mm |
| 5% traction: | 1.05 x 4160 mm = 4368 mm |

The selected tire 440/80R28 has a rolling circumference (4202 mm < 4266 mm < 4368 mm)

which is within the limit given by the manufacturer.

The front tire's traction is  $4266 / 4160 = 1.025$ , i.e. 2.5%.

The methods above can be used to check the suitability of new tires when mounting them on a tractor with a known gear ratio. However, if this vital information is not available, you should contact the tractor's manufacturer or importer.

# MINE TIRE MAINTENANCE

To utilise the full capacity of a mining tire, it is recommended to check the inflation pressure at least once a week. Keeping the pressure at a sufficient level prevents tire break-up caused by high heat generation. Pressure maintenance reduces cuts and cracks on tire sidewalls by keeping the tire contour in design width.

It is also recommended to keep a tire check diary. This makes it easier to determine the interval and the need for maintenance. A diary helps maintenance when machines are operated in several shifts and by different operators. Regular check-ups help in starting repair procedures early enough to save in tire costs.

When checking the inflation pressure, please observe also the tire temperature. A rise of 10 degrees centigrade / 50 Fahrenheit will increase the inflation pressure approximately 0,35 bar / 5,1 psi at 10 bar pressure level. Use only reliable and calibrated pressure gauges. A regular gauge re-calibration should also be performed.

A cut on a tire sidewall, caused in example by sharp stones, should always be repaired before it proceeds to let moisture reach into the tire reinforcing cords.

Narrow mine tunnels often wear tread more from the outer side of a tire. It is recommended to swap tires from one side to the other to gain more tire hours.

The Nokian Tyres Mine L-5S features a tread wear indicator. Besides this it is also recommended to mark the actual tread wear (mm / in) into the tire check diary.

In handling a TL (tubeless) tire make sure that the rim is not damaged. Even a small abrasion on a tire by a damaged or a faulty rim can lead to excessive air leak. A defective rim is always a serious safety hazard. With a TL tire always use a tubeless rim.

**Notice!** Regular inflation pressure maintenance ensures long service life.

# HAKKAPELIITTA LOADER INFLATION PRESSURE RECOMMENDATIONS FOR DIFFERENT WHEEL LOADERS

## SIZE: 17.5R25

| Manufacturer | Model      | Empty vehicle weight |        | Tipping load static |        | Inflation pressure Front axle |     | Inflation pressure Rear axle |     |
|--------------|------------|----------------------|--------|---------------------|--------|-------------------------------|-----|------------------------------|-----|
|              |            | kg                   | lb     | kg                  | lb     | kPa                           | psi | kPa                          | psi |
| CAT          | IT14G*     | 8 450                | 18 629 | 4 500               | 9 921  | 375                           | 54  | 225                          | 33  |
| CAT          | 914K*      | 8 181                | 18 036 | 5 578               | 12 297 | 375                           | 54  | 225                          | 33  |
| CAT          | 924H       | 11 730               | 25 860 | 8 740               | 19 268 | 450                           | 65  | 300                          | 44  |
| JCB          | 411 & 413S | 8 830                | 19 467 | 6 610               | 14 573 | 375                           | 54  | 225                          | 33  |
| JCB          | 417S ZX    | 9 510                | 20 966 | 7 250               | 15 984 | 400                           | 58  | 225                          | 33  |
| JCB          | 418S ZX    | 9 600                | 21 164 | 7 240               | 15 962 | 400                           | 58  | 250                          | 36  |
| Liebherr     | L524       | 11 100               | 24 471 | 8 500               | 18 739 | 475                           | 69  | 300                          | 44  |
| Liebherr     | L528       | 11 500               | 25 353 | 9 560               | 21 076 | 500                           | 73  | 325                          | 47  |
| Ljungby      | L9         | 10 500               | 23 146 | 6 500               | 14 330 | 450                           | 65  | 300                          | 44  |
| Volvo        | L60H       | 12 400               | 27 337 | 6 570               | 14 484 | 500                           | 73  | 300                          | 44  |

ASSUMPTIONS: Normal bucket. Max speed with full bucket 12.5 mph / \*20 mph. Max speed with empty vehicle 25 mph.

ASSUMPTIONS: Normal bucket. Max speed with full bucket 20 km/h / \*30 km/h. Max speed with empty vehicle 40 km/h

## SIZE: 20.5R25

| Manufacturer | Model | Empty vehicle weight |        | Tipping load static |        | Inflation pressure Front axle |     | Inflation pressure Rear axle |     |
|--------------|-------|----------------------|--------|---------------------|--------|-------------------------------|-----|------------------------------|-----|
|              |       | kg                   | lb     | kg                  | lb     | kPa                           | psi | kPa                          | psi |
| CAT          | 930K  | 14 400               | 31 747 | 10 100              | 22 267 | 400                           | 58  | 275                          | 40  |
| CAT          | 938K  | 16 350               | 36 046 | 12 200              | 26 896 | 475                           | 69  | 300                          | 44  |
| Komatsu      | 270-7 | 13 100               | 28 881 | 10 100              | 22 267 | 350                           | 51  | 225                          | 33  |
| Komatsu      | 320-7 | 16 000               | 35 274 | 11 560              | 25 485 | 450                           | 65  | 300                          | 44  |
| Liebherr     | L538  | 13 400               | 29 542 | 10 700              | 23 590 | 375                           | 54  | 250                          | 36  |
| Liebherr     | L542  | 14 000               | 30 865 | 11 600              | 25 574 | 400                           | 58  | 275                          | 40  |
| Volvo        | L70H  | 14 480               | 31 923 | 9 860               | 21 738 | 400                           | 58  | 275                          | 40  |
| Volvo        | L90H  | 15 990               | 35 252 | 11 470              | 25 287 | 450                           | 65  | 300                          | 44  |

ASSUMPTIONS: Normal bucket. Max speed with full bucket 12.5 mph. Max speed with empty vehicle 25 mph.

ASSUMPTIONS: Normal bucket. Max speed with full bucket 20 km/h. Max speed with empty vehicle 40 km/h

**SIZE: 23.5R25**

| Manufacturer | Model                 | Empty vehicle weight |        | Tipping load static |        | Inflation pressure Front axle |     | Inflation pressure Rear axle |     |
|--------------|-----------------------|----------------------|--------|---------------------|--------|-------------------------------|-----|------------------------------|-----|
|              |                       | kg                   | lb     | kg                  | lb     | kPa                           | psi | kPa                          | psi |
| CAT          | 950K                  | 20 131               | 44 381 | 13 719              | 30 245 | 450                           | 65  | 300                          | 44  |
| CAT          | 962M                  | 20 226               | 44 591 | 13 358              | 29 449 | 450                           | 65  | 300                          | 44  |
| Komatsu      | WA380-6               | 17 583               | 38 764 | 14 563              | 32 106 | 375                           | 54  | 200                          | 29  |
| Komatsu      | WA430-6               | 18 533               | 40 858 | 14 963              | 32 998 | 400                           | 58  | 225                          | 33  |
| Liebherr     | L550                  | 16 590               | 36 575 | 13 204              | 29 110 | 350                           | 51  | 225                          | 33  |
| Ljungby      | L18, Tier IIIB engine | 19 000               | 41 888 | 13 900              | 30 644 | 425                           | 62  | 275                          | 40  |
| Volvo        | L110G                 | 18 405               | 40 576 | 14 401              | 31 749 | 375                           | 54  | 225                          | 33  |
| Volvo        | L120F                 | 20 010               | 44 116 | 14 540              | 32 055 | 450                           | 65  | 300                          | 44  |

ASSUMPTIONS: Normal bucket. Max speed with full bucket 12.5 mph / \*20 mph. Max speed with empty vehicle 25 mph.

ASSUMPTIONS: Normal bucket. Max speed with full bucket 20 km/h / \*30 km/h. Max speed with empty vehicle 40 km/h

## STUDS

Nokian Tyres Hakkapeliitta Loader pattern offers an excellent winter grip. To gain even more traction and grip in extreme wet icy conditions the tires can be studded. The following schematic picture shows the studding sequence

## STUD RECOMMENDATION

- Recommended types are truck, tractor or construction machine studs
- Maximum stud length is 25 mm / 1 in
- Minimum stud flange is 9 mm / 11/32 in

## NUMBER OF STUDS

| Size     | Number of studs |
|----------|-----------------|
| 14.00R24 | 168             |
| 17.5R25  | 168             |
| 20.5R25  | 168             |
| 23.5R25  | 168             |

## NOKIAN TYRES HAKKAPELIITTA LOADER



Stud places marked.

# GROUND KARE AND EXCAVATOR MOUNTING RECOMMENDATIONS

Nokian Tyres 24PR Excavator and Nokian Tyres Ground Kare tires are developed for high load capacities with a maximum inflation pressure of 600 kPa. Nokian Tyres 20PR Excavator tires are developed for high load capacities with a maximum inflation pressure of 450 kPa.

Please note that the wheel's load capacity must meet the machine requirements. The tire mounted on the wheel must have a high enough load capacity as well. Also make sure that the wheel's maximum inflation pressure capability meets the allowed maximum pressure of the tire.

As stated by the ETRTO, consult the rim and wheel manufacturers for load capacity compatibility ("Standards Manual 2019", p. R.4 "General Notes. Strength.")

**The rim's horn (or flange)** shall have a shape that does not damage a tire during mounting. Such rims have: a round/tube shape horn or a well bent down/long horn. For the rim's horn suitability, please consult the tire manufacturer.

**The rim's contour** has to meet ETRTO requirements ("15° Drop-Centre Rims Width Codes AG Contour. Basic Contour" p. R.36, ETRTO 2019). Additionally the diagonal mounting distance has to meet the requirements set by the ETRTO (Engineering Design Information 2019 p. RM.2 "Contour changes of drop-center rims"). For the rim's contour suitability, please contact the tire manufacturer.

Mounting Nokian Tyres Excavator and Nokian Tyres Ground Kare tires always requires a two clamp mounting method by Nokian Tyres. For the bigger clamp, please always use HTTMC00001 clamp developed by Nokian Tyres.

## RECOMMENDED SHAPE:

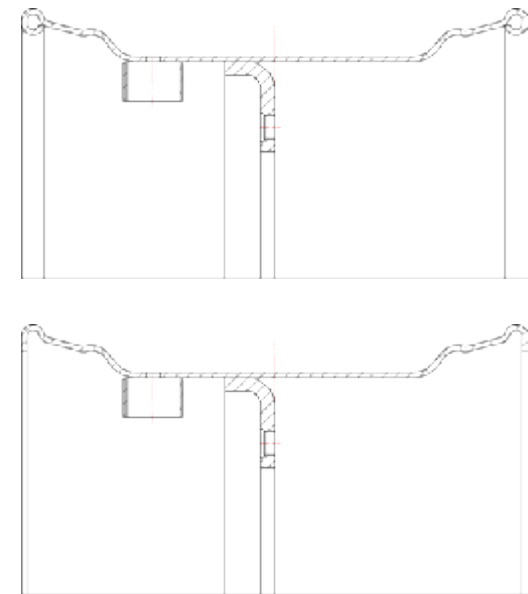

**NON-RECOMMENDED SHAPE:**

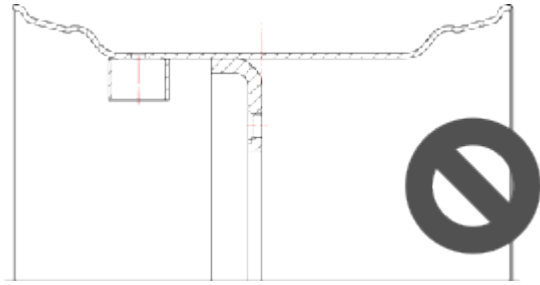



# NOKIAN TYRES INTUITU™ SMART TIRES

Digital tires are the key to more efficient, safer and more sustainable working. With Nokian Tyres Intuitu™ smart tires and mobile app, you always know how your tires are doing – from one tire to the entire fleet.

**nokian**  
**TYRES**

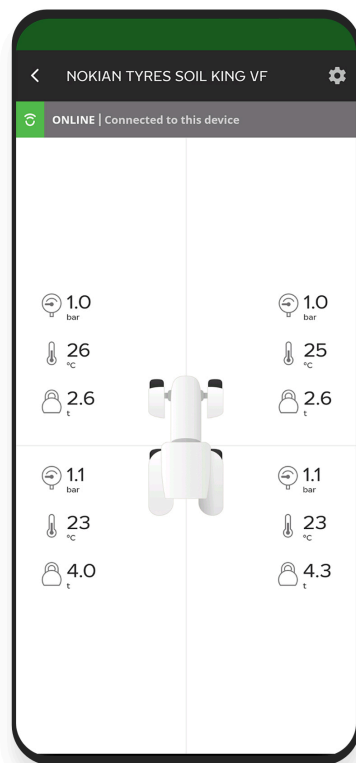

Designed and developed by Nokian Tyres, the Nokian Tyres Intuitu sensor measures tire pressure, temperature and load\* directly from the inside surface of the tire. It sends measurements every minute via Bluetooth to the Nokian Tyres Intuitu mobile app.

When the app detects abnormal tire conditions, it alerts the user. With the power of the Intuitu cloud, all drivers and fleet managers can see the condition of all fleet tires remotely (internet connection required).

### MORE SAVINGS

Smart tire pressure monitoring is important for grip and stability as well as fuel consumption and tire service life. With Nokian Tyres Intuitu, you can be sure you'll get the most out of your tire investment.

### MORE SAFETY

High tire temperatures are linked to tire damage and are a safety risk. Nokian Tyres Intuitu tire monitoring system alerts you on time, making your entire operation more informed, safer and sustainable.

### MORE WARRANTY

By registering your tires on Nokian Tyres Intuitu, you will get a one-year extension to normal tire

warranty and a direct communication channel with Nokian Tyres.

### TECHNICAL SPECIFICATION

|                             |                                                                                      |
|-----------------------------|--------------------------------------------------------------------------------------|
| Operating temperature range | -40 to 80°C (+/- 2 °C) (-40 °C to -20 °C with limited functionality and performance) |
| Pressure measurement range  | 0-9 bar (+/- 0.04 bar)                                                               |
| Load measurement*           | +/- 5 % accuracy 6-30 km/h                                                           |
| Connection to mobile phone  | Bluetooth low energy                                                                 |
| Sensor battery life         | 10 000 active hours typical usage. Non-replaceable battery                           |
| Phone operating systems     | Android 8 onwards   iOS 11 onwards                                                   |
| Alarms                      | Low pressure, high temperature, high speed                                           |

\* Intuitu 2.0 only

**Notice!** Do not use with liquids or inert tubes in the tire. For more detailed information and FAQs, please go to [www.nokiantyres.com/intuitu](http://www.nokiantyres.com/intuitu)

**Nokian Tyres Intuitu available with:** *Nokian Tyres Float King VF, Nokian Tyres Ground King, Nokian Tyres Tractor King, Nokian Tyres TRI 2, Nokian Tyres Hakkapeliitta TRI, Nokian Tyres Country King, Nokian Tyres CT, Nokian Tyres Excavator, Nokian Tyres Ground Kare*

**Nokian Tyres Intuitu 2.0 available with:** *Nokian*

*Tyres Soil King VF*

# REGROOVING OF NOKIAN TYRES TRUCK & BUS TIRES

## INTRODUCTION

Tire regrooving extends the life cycle of Nokian Tyres steel radial tires for buses and trucks. Tire regrooving can be done on new tires by cutting into the tread as instructed by Nokian Tyres.

### To ensure safety and minimize tire damages, the following should be taken into account:

- Only professional operators should perform the regrooving process.
- Only competent tools suitable for the process should be used with electrically heated blades.
- The blades in the cutter heads need to be set to the correct, specified depth.
- The blade setting depth for each individual tire must be determined by referring to the information charts presented in this technical manual in order to prevent the appearance of plies at the bottom of the tread and damage to the tire structure.
- The heating of the blade begins automatically when the blade pierces the rubber.
- The cutter must be held in a way that the underside of the cutting head is flat against the tread surface when regrooving.
- During the regrooving process, a minimum depth of leftover under-tread rubber is required to avoid injuries of the top steel belt, stone-chips as well as groove cracking that can cause rib tears.

## GUIDELINES

- 1. Before regrooving, tires must be demounted from the wheel completely**
- 2. Inspections the tires must include following steps:**
  - Before regrooving, possible damages on any part of the tire must be checked carefully.
  - When selecting a tire for regrooving, special attention needs to be paid to the tire condition when the tread area is in any way damaged. This includes for example chipping, tearing and cutting due to abnormal operating conditions.
  - Stones and other foreign objects, such as nails and other sharp objects, that may have embedded into the tire grooves must be removed. If needed, the possible damages from the foreign objects must be repaired before starting the regrooving process.
  - When a tire is abnormally or intensely worn, regrooving the worn parts of the tire may still be possible if an adequate amount of the original groove is visible before regrooving.
- 3. The minimum remaining tread depth of the tire should be between 3–4 mm before regrooving.**
  - To find the minimum remaining depth, the tread depth must be measured carefully at 4 different places around the tire circumference.
  - The cutter blade needs to be set for the recommendations as shown in the information charts of this technical manual.
- 4. The regrooved tire should be free from all defects and injuries.**
  - To ensure complete safety, it is extremely important to confirm that the belts under the regrooved tread are not exposed in any parts.

## EXAMPLE:



Minimum remaining tread depth = 3 mm (D1)

Recommended regrooving depth = 3 mm (D2)

Depth to which cutter blade is set = 6 mm (D1+D2)

Recommended regrooving width = W

# REGROOVING RECOMMENDATIONS

THE MAXIMUM RECOMMENDED DEPTH IS THE INCREASING DEPTH.

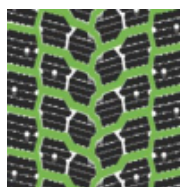

**NOKIAN TYRES HAKKAPELIITTA TRUCK E2**

| Tire size   | Regrooving depth | Width of regrooving | Blade |
|-------------|------------------|---------------------|-------|
| 275/70R22.5 | 2.5 mm           | 7-8 mm              | R3    |
| 295/80R22.5 | 3.0 mm           | 7-8 mm              | R3    |
| 315/70R22.5 | 2.5 mm           | 7-8 mm              | R3    |
| 315/80R22.5 | 3.0 mm           | 7-8 mm              | R3    |

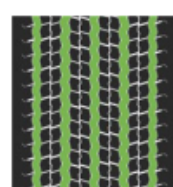

**NOKIAN TYRES HAKKAPELIITTA TRUCK F2**

| Tire size   | Regrooving depth | Width of regrooving | Blade |
|-------------|------------------|---------------------|-------|
| 295/80R22.5 | 3.0 mm           | 8-9 mm              | R3    |
| 315/70R22.5 | 3.0 mm           | 8-9 mm              | R3    |
| 315/80R22.5 | 3.0 mm           | 8-9 mm              | R3    |
| 385/55R22.5 | 3.0 mm           | 8-9 mm              | R3    |
| 385/65R22.5 | 3.0 mm           | 8-9 mm              | R3    |

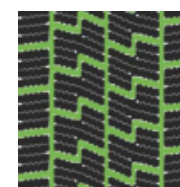

**NOKIAN TYRES HAKKAPELIITTA TRUCK D**

| Tire size   | Regrooving depth | Width of regrooving | Blade |
|-------------|------------------|---------------------|-------|
| 275/70R22.5 | 2.5 mm           | 7-8 mm              | R3    |
| 295/80R22.5 | 3.0 mm           | 7-8 mm              | R3    |
| 315/70R22.5 | 2.5 mm           | 7-8 mm              | R3    |
| 315/80R22.5 | 3.0 mm           | 7-8 mm              | R3    |

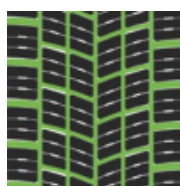

**NOKIAN TYRES HAKKA TRUCK DRIVE**

| Tire size   | Regrooving depth | Width of regrooving | Blade |
|-------------|------------------|---------------------|-------|
| 295/60R22.5 | 2.5 mm           | 7-8 mm              | R3    |
| 315/60R22.5 | 2.5 mm           | 7-8 mm              | R3    |
| 295/80R22.5 | 3.0 mm           | 7-8 mm              | R3    |
| 315/70R22.5 | 3.0 mm           | 7-8 mm              | R3    |
| 315/80R22.5 | 3.0 mm           | 7-8 mm              | R3    |



**NOKIAN TYRES HAKKA TRUCK COACH**

| Tire size   | Regrooving depth | Width of regrooving | Blade |
|-------------|------------------|---------------------|-------|
| 295/80R22.5 | 2.5 mm           | 6-7 mm              | R3    |
| 315/80R22.5 | 2.5 mm           | 6-7 mm              | R3    |

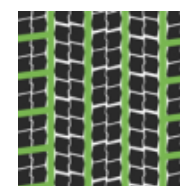

**NOKIAN TYRES HAKKAPELIITTA CITY BUS**

| Tire size   | Regrooving depth | Width of regrooving | Blade |
|-------------|------------------|---------------------|-------|
| 275/70R22.5 | 3.0 mm           | 6-7 mm              | R3    |
| 295/80R22.5 | 2.5 mm           | 6-7 mm              | R3    |

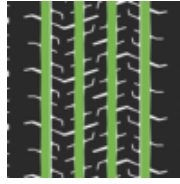

**NOKIAN TYRES HAKKA TRUCK STEER**

| Tire size   | Regrooving depth | Width of regrooving | Blade |
|-------------|------------------|---------------------|-------|
| 315/60R22.5 | 3.0 mm           | 8-9 mm              | R3    |
| 295/80R22.5 | 3.0 mm           | 8-9 mm              | R3    |
| 315/70R22.5 | 3.0 mm           | 8-9 mm              | R3    |
| 315/80R22.5 | 3.0 mm           | 8-9 mm              | R3    |
| 385/55R22.5 | 3.0 mm           | 8-9 mm              | R3    |
| 385/65R22.5 | 3.0 mm           | 8-9 mm              | R3    |

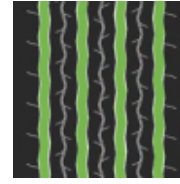

**NOKIAN TYRES E-TRUCK TRAILER**

| Tire size   | Regrooving depth | Width of regrooving | Blade |
|-------------|------------------|---------------------|-------|
| 215/75R17.5 | 2.0 mm           | 6-7 mm              | R3    |
| 235/75R17.5 | 2.0 mm           | 6-7 mm              | R3    |
| 245/70R17.5 | 2.0 mm           | 6-7 mm              | R3    |
| 265/70R19.5 | 2.5 mm           | 7-9 mm              | R3    |
| 385/55R22.5 | 2.5 mm           | 7-9 mm              | R3    |
| 385/65R22.5 | 2.5 mm           | 7-9 mm              | R3    |

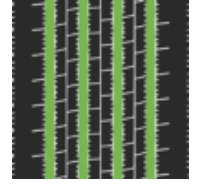

**NOKIAN TYRES E-TRUCK STEER**

| Tire size   | Regrooving depth | Width of regrooving | Blade |
|-------------|------------------|---------------------|-------|
| 215/75R17.5 | 1.5 mm           | 6-7 mm              | R3    |
| 235/75R17.5 | 1.5 mm           | 6-7 mm              | R3    |
| 265/70R19.5 | 1.5 mm           | 7-8 mm              | R3    |
| 285/70R19.5 | 1.5 mm           | 7-8 mm              | R3    |
| 295/80R22.5 | 2.0 mm           | 8-9 mm              | R3    |
| 315/70R22.5 | 2.0 mm           | 8-9 mm              | R3    |
| 315/80R22.5 | 2.5 mm           | 8-9 mm              | R3    |
| 385/65R22.5 | 2.0 mm           | 8-9 mm              | R3    |
| 385/55R22.5 | 2.0 mm           | 8-9 mm              | R3    |

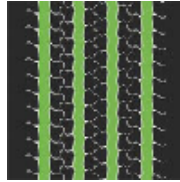

**NOKIAN TYRES HAKKA TRUCK TRAILER**

| Tire size   | Regrooving depth | Width of regrooving | Blade |
|-------------|------------------|---------------------|-------|
| 265/70R19.5 | 2.5 mm           | 7-8 mm              | R3    |
| 275/70R22.5 | 3.0 mm           | 8-9 mm              | R3    |
| 385/65R22.5 | 2.5 mm           | 8-9 mm              | R3    |
| 385/55R22.5 | 2.0 mm           | -9mm                | R3    |



**NOKIAN TYRES R-TRUCK TRAILER**

| Tire size   | Regrooving depth | Width of regrooving | Blade |
|-------------|------------------|---------------------|-------|
| 265/70R19.5 | 3.0 mm           | 7-8 mm              | R3    |
| 285/70R19.5 | 3.0 mm           | 8-10 mm             | R4    |
| 275/70R22.5 | 3.0 mm           | 8-10 mm             | R4    |
| 385/65R22.5 | 3.0 mm           | 8-10 mm             | R4    |



**NOKIAN TYRES R-TRUCK STEER**

| Tire size   | Regrooving depth | Width of regrooving | Blade |
|-------------|------------------|---------------------|-------|
| 315/80R22.5 | 3.0 mm           | 8-10 mm             | R4    |
| 385/65R22.5 | 3.0 mm           | 8-10 mm             | R4    |



**NOKIAN TYRES HAKKA TRUCK 844/  
844PLUS**

| Tire size   | Regrooving depth | Width of regrooving | Blade |
|-------------|------------------|---------------------|-------|
| 265/70R19.5 | 2.5 mm           | 7-8 mm              | R3    |
| 275/70R22.5 | 3.0 mm           | 8-9 mm              | R3    |
| 385/55R22.5 | 3.0 mm           | 8-9 mm              | R3    |



**NOKIAN TYRES R-TRUCK DRIVE**

| Tire size   | Regrooving depth | Width of regrooving | Blade |
|-------------|------------------|---------------------|-------|
| 315/80R22.5 | 3.0 mm           | 8-10 mm             | R4    |



**NOKIAN TYRES E-TRUCK DRIVE**

| Tire size   | Regrooving depth | Width of regrooving | Blade |
|-------------|------------------|---------------------|-------|
| 215/75R17.5 | 1.5 mm           | 6-7 mm              | R3    |
| 235/75R17.5 | 1.5 mm           | 6-7 mm              | R3    |
| 265/70R19.5 | 1.5 mm           | 6-7 mm              | R3    |
| 285/70R19.5 | 1.5 mm           | 6-7 mm              | R3    |
| 295/80R22.5 | 2.5 mm           | 7-8 mm              | R3    |
| 315/70R22.5 | 2.5 mm           | 7-8 mm              | R3    |
| 315/80R22.5 | 2.5 mm           | 7-8 mm              | R3    |

# STUDDING OF NOKIAN TYRES HAKKAPELIITTA TRUCK BRANDED TIRES

**Most of the Nokian Tyres Hakkapeliitta Truck branded tires have pre-marked stud places where the studs can be installed following the below instructions.**

- Recommended stud for truck tires has a length of 15 mm and flange diameter of 11 mm. Recommended drilling diameter is 5 mm and drilling depth is 13 mm.
- It should be noted that there are national regulations about the maximum stud weight, which must be followed. For example, in Finland, the maximum stud weight for heavy vehicles (over 3,5 ton) is 5 g.

## STUDDING PLAN BY TREAD DESIGN AND TIRE SIZE

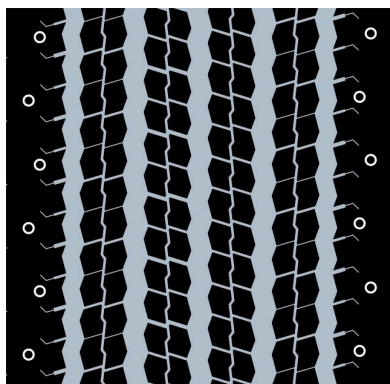

**HAKKAPELIITTA TRUCK F2**

| Tire size   | Number of studs |
|-------------|-----------------|
| 295/80R22.5 | 158             |
| 315/70R22.5 | 152             |
| 315/80R22.5 | 160             |
| 385/55R22.5 | 136             |
| 385/65R22.5 | 142             |

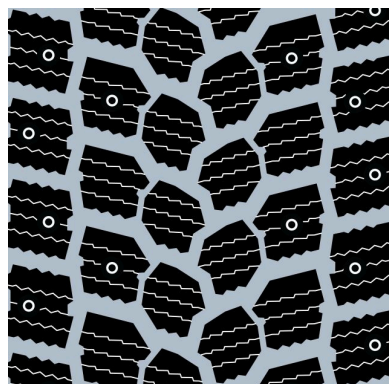

**HAKKAPELIITTA TRUCK E2**

| Tire size   | Number of studs |
|-------------|-----------------|
| 275/70R22.5 | 150             |
| 295/80R22.5 | 168             |
| 315/70R22.5 | 162             |
| 315/80R22.5 | 174             |

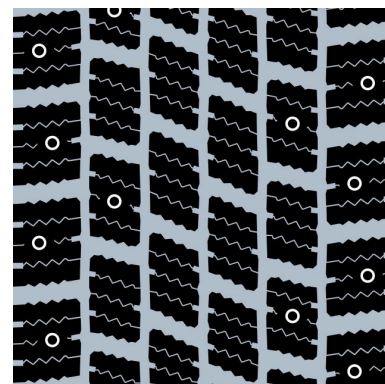

**HAKKAPELIITTA TRUCK D**

| Tire size   | Number of studs |
|-------------|-----------------|
| 275/70R22.5 | 146             |

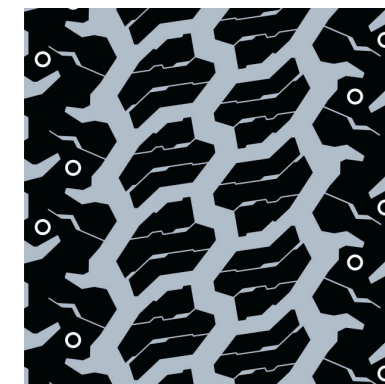

**HAKKAPELIITTA TRUCK T**

| Tire size   | Number of studs |
|-------------|-----------------|
| 265/70R19.5 | 114             |

# AREAS OF USE AND EU LABEL INFO

## EU TIRE LABELS FOR EASY COMPARISON

From May 1st 2021, also truck and bus tires must carry the EU tire label. The labels show important tire properties such as grip, fuel efficiency and noise level at a glance, making it easy to choose a safer, more eco-friendly tire.

You can find the EU label information on each Nokian Tyres product page by clicking on “Show more” under the size information. [NOKIANTYRES.COM/HEAVY/EU-LABELS](https://www.nokiantyres.com/heavy/eu-labels)

|                          | Winter use                                                                        | Long distance                                                                     | Regional                                                                          | Light & medium trucks                                                              | Timber transport                                                                    | On/Off road                                                                         | Long distance buses                                                                 | City buses                                                                          | 3PMSF M+S markings |
|--------------------------|-----------------------------------------------------------------------------------|-----------------------------------------------------------------------------------|-----------------------------------------------------------------------------------|------------------------------------------------------------------------------------|-------------------------------------------------------------------------------------|-------------------------------------------------------------------------------------|-------------------------------------------------------------------------------------|-------------------------------------------------------------------------------------|--------------------|
|                          |  |  |  |  |  |  |  |  |                    |
| <b>Steer</b>             |                                                                                   |                                                                                   |                                                                                   |                                                                                    |                                                                                     |                                                                                     |                                                                                     |                                                                                     |                    |
| Hakkapeliitta Truck F2   | **                                                                                | ██████████                                                                        |                                                                                   |                                                                                    | ██████████                                                                          | ██████████                                                                          | ██████████                                                                          | ██████████                                                                          | 3PMSF, M+S         |
| Hakka Truck Coach        | **                                                                                | ██████████                                                                        |                                                                                   |                                                                                    |                                                                                     |                                                                                     | ██████████                                                                          |                                                                                     | 3PMSF, M+S         |
| Hakkapeliitta City Bus   | **                                                                                |                                                                                   |                                                                                   |                                                                                    |                                                                                     |                                                                                     |                                                                                     | ██████████                                                                          | 3PMSF, M+S         |
| Hakka Truck Steer        | *                                                                                 | ██████████                                                                        |                                                                                   |                                                                                    |                                                                                     |                                                                                     | ██████████                                                                          | ██████████                                                                          | 3PMSF, M+S         |
| Hakka Truck 844PLUS      | *                                                                                 |                                                                                   | ██████████                                                                        |                                                                                    |                                                                                     |                                                                                     |                                                                                     | ██████████                                                                          | 3PMSF, M+S         |
| E-Truck Steer            | *                                                                                 | ██████████                                                                        |                                                                                   |                                                                                    |                                                                                     |                                                                                     | ██████████                                                                          | ██████████                                                                          | 3PMSF, M+S         |
| E-Truck Steer 17.5"      | *                                                                                 |                                                                                   |                                                                                   | ██████████                                                                         |                                                                                     |                                                                                     |                                                                                     | ██████████                                                                          | 3PMSF, M+S         |
| E-Truck Steer 19.5"      | *                                                                                 |                                                                                   | ██████████                                                                        | ██████████                                                                         |                                                                                     |                                                                                     |                                                                                     |                                                                                     | 3PMSF, M+S         |
| R-Truck Steer            | *                                                                                 |                                                                                   |                                                                                   |                                                                                    | ██████████                                                                          | ██████████                                                                          |                                                                                     |                                                                                     | 3PMSF, M+S         |
| <b>Drive</b>             |                                                                                   |                                                                                   |                                                                                   |                                                                                    |                                                                                     |                                                                                     |                                                                                     |                                                                                     |                    |
| Hakkapeliitta Truck D    | **                                                                                | ██████████                                                                        | ██████████                                                                        |                                                                                    |                                                                                     |                                                                                     | ██████████                                                                          | ██████████                                                                          | 3PMSF, M+S         |
| Hakkapeliitta Truck E/E2 | **                                                                                | ██████████                                                                        | ██████████                                                                        |                                                                                    | ██████████                                                                          | ██████████                                                                          | ██████████                                                                          | ██████████                                                                          | 3PMSF, M+S         |
| Hakka Truck Coach        | **                                                                                | ██████████                                                                        |                                                                                   |                                                                                    |                                                                                     |                                                                                     | ██████████                                                                          |                                                                                     | 3PMSF, M+S         |

|                        | Winter use<br> | Long distance<br> | Regional<br> | Light & medium trucks<br> | Timber transport<br> | On/Off road<br> | Long distance buses<br> | City buses<br> | 3PMSF<br>M+S<br>markings |
|------------------------|-------------------------------------------------------------------------------------------------|----------------------------------------------------------------------------------------------------|-----------------------------------------------------------------------------------------------|-------------------------------------------------------------------------------------------------------------|---------------------------------------------------------------------------------------------------------|----------------------------------------------------------------------------------------------------|------------------------------------------------------------------------------------------------------------|---------------------------------------------------------------------------------------------------|--------------------------|
| Hakkapeliitta City Bus | **                                                                                              |                                                                                                    |                                                                                               |                                                                                                             |                                                                                                         |                                                                                                    |                                                                                                            |                | 3PMSF, M+S               |
| Hakka Truck Drive      | **                                                                                              |                   |              |                                                                                                             |                                                                                                         |                                                                                                    |                         |                | 3PMSF, M+S               |
| Hakkapeliitta Truck T  | **                                                                                              |                                                                                                    |              |                                                                                                             |                                                                                                         |                                                                                                    |                                                                                                            |                                                                                                   | 3PMSF, M+S               |
| E-Truck Drive          | *                                                                                               |                   |                                                                                               |                                                                                                             |                                                                                                         |                                                                                                    |                         |                | 3PMSF, M+S               |
| E-Truck Drive 17.5"    | *                                                                                               |                                                                                                    |                                                                                               |                           |                                                                                                         |                                                                                                    |                                                                                                            |                                                                                                   | 3PMSF, M+S               |
| E-Truck Drive 19.5"    | *                                                                                               |                                                                                                    |              |                           |                                                                                                         |                                                                                                    |                                                                                                            |                                                                                                   | 3PMSF, M+S               |
| R-Truck Drive          | *                                                                                               |                                                                                                    |                                                                                               |                                                                                                             |                      |                 |                                                                                                            |                                                                                                   | 3PMSF, M+S               |
| <b>Trailer</b>         |                                                                                                 |                                                                                                    |                                                                                               |                                                                                                             |                                                                                                         |                                                                                                    |                                                                                                            |                                                                                                   |                          |
| Hakkapeliitta Truck F2 | **                                                                                              |                   |                                                                                               |                                                                                                             |                                                                                                         |                                                                                                    |                                                                                                            |                                                                                                   | 3PMSF, M+S               |
| Hakkapeliitta Truck T  | **                                                                                              |                   |              |                                                                                                             |                      |                                                                                                    |                                                                                                            |                                                                                                   | 3PMSF, M+S               |
| Hakka Truck Trailer    | **                                                                                              |                   |                                                                                               |                                                                                                             |                                                                                                         |                                                                                                    |                                                                                                            |                                                                                                   | 3PMSF, M+S               |
| Hakka Truck 844PLUS    | *                                                                                               |                   |              |                                                                                                             |                                                                                                         |                                                                                                    |                                                                                                            |                                                                                                   | 3PMSF, M+S               |
| Hakka Truck 844        | *                                                                                               |                   |              |                                                                                                             |                                                                                                         |                                                                                                    |                                                                                                            |                                                                                                   | 3PMSF, M+S               |
| E-Truck Trailer        | *                                                                                               |                  |                                                                                               |                                                                                                             |                                                                                                         |                                                                                                    |                                                                                                            |                                                                                                   | 3PMSF, M+S               |
| R-Truck Trailer        | *                                                                                               |                 |            |                                                                                                             |                    |                                                                                                    |                                                                                                            |                                                                                                   | 3PMSF, M+S               |

\*\* Excellent grip in severe winter conditions

\* Good grip in normal winter road conditions

# HOW TO USE LOAD CAPACITY TABLES?

## Q: HOW TO FIND THE RIGHT INFLATION PRESSURE?

**Tire:** 650/65R26.5 174 D ELS  
**Load per tire:** 7 000 kg / 15 432 lb  
**Max speed of vehicle:** 40 km/h / 25 mph

**A: Correct inflation pressure is 2.8 bar / 41 psi**

**SIZE 650/65R26.5 174 D**

| Constant |      | 0.8 bar | 12 psi | 1.2 bar | 17 psi | 1.6 bar | 23 psi | 2.0 bar | 29 psi | 2.4 bar | 35 psi | 2.8 bar | 41 psi | 3.2 bar | 46 psi | 3.6 bar | 53 psi | 4.0 bar | 58 psi |
|----------|------|---------|--------|---------|--------|---------|--------|---------|--------|---------|--------|---------|--------|---------|--------|---------|--------|---------|--------|
| km/h     | mph  | kg      | lbs    | kg      | lbs    | kg      | lbs    | kg      | lbs    | kg      | lbs    | kg      | lbs    | kg      | lbs    | kg      | lbs    | kg      | lbs    |
| 10       | 5    | 4 260   | 9 390  | 5 400   | 11 905 | 6 400   | 14 110 | 7 200   | 15 875 | 8 350   | 18 410 | 9 300   | 20 505 | 10 100  | 22 265 | 11 100  | 24 470 | 12 100  | 26 675 |
| 20       | 12.5 | 3 900   | 8 600  | 4 960   | 10 935 | 5 860   | 12 920 | 6 600   | 14 550 | 7 650   | 16 865 | 8 500   | 18 740 | 9 250   | 20 395 | 10 150  | 22 375 | 11 100  | 24 470 |
| 25       | 15   | 3 740   | 8 245  | 4 740   | 10 450 | 5 620   | 12 390 | 6 350   | 14 000 | 7 350   | 16 205 | 8 150   | 17 965 | 8 850   | 19 510 | 9 750   | 21 495 | 10 600  | 23 370 |
| 30       | 20   | 3 580   | 7 890  | 4 540   | 10 010 | 5 380   | 11 860 | 6 050   | 13 340 | 7 000   | 15 430 | 7 800   | 17 195 | 8 500   | 18 740 | 9 300   | 20 505 | 10 150  | 22 375 |
| 40       | 25   | 3 220   | 7 100  | 4 080   | 8 995  | 4 840   | 10 670 | 5 440   | 11 995 | 6 300   | 13 870 | 7 050   | 15 540 | 7 650   | 16 865 | 8 400   | 18 520 | 9 150   | 20 170 |
| 50       | 30   | 2 860   | 6 305  | 3 640   | 8 025  | 4 300   | 9 480  | 4 840   | 10 670 | 5 600   | 12 345 | 6 250   | 13 780 | 6 800   | 14 990 | 7 450   | 16 425 | 8 150   | 17 965 |
| 65       | 40   | 2 360   | 5 205  | 3 000   | 6 615  | 3 550   | 7 825  | 4 000   | 8 820  | 4 625   | 10 195 | 5 150   | 11 355 | 5 600   | 12 345 | 6 150   | 13 560 | 6 700   | 14 770 |

## Q: HOW TO FIND A MAXIMUM SPEED FOR THE APPLICATION (HIGHEST SPEED WITH THE CHOSEN TIRE)?

**Tire:** 650/60R34 175 D  
**Load per tire:** 10 000 kg / 22 046 lb  
**Inflation pressure:** 4.0 bar / 58 psi. Use tire maximum inflation pressure to gain the highest speed value

**A: Maximum speed is 30 km/h / 20 mph**

**SIZE 650/60R34 175 D**

| Constant |      | 0.8 bar | 12 psi | 1.2 bar | 17 psi | 1.6 bar | 23 psi | 2.0 bar | 29 psi | 2.4 bar | 35 psi | 2.8 bar | 41 psi | 3.2 bar | 46 psi | 3.6 bar | 53 psi | 4.0 bar | 58 psi |
|----------|------|---------|--------|---------|--------|---------|--------|---------|--------|---------|--------|---------|--------|---------|--------|---------|--------|---------|--------|
| km/h     | mph  | kg      | lbs    | kg      | lbs    | kg      | lbs    | kg      | lbs    | kg      | lbs    | kg      | lbs    | kg      | lbs    | kg      | lbs    | kg      | lbs    |
| 10       | 5    | 4 500   | 9 920  | 5 540   | 12 215 | 6 750   | 14 880 | 7 650   | 16 865 | 8 550   | 18 850 | 9 850   | 21 715 | 10 450  | 23 040 | 11 350  | 25 020 | 12 450  | 27 445 |
| 20       | 12.5 | 4 140   | 9 125  | 5 080   | 11 200 | 6 200   | 13 670 | 7 050   | 15 540 | 7 850   | 17 305 | 9 000   | 19 840 | 9 600   | 21 165 | 10 400  | 22 930 | 11 400  | 25 130 |
| 25       | 15   | 3 960   | 8 730  | 4 860   | 10 715 | 5 940   | 13 095 | 6 750   | 14 880 | 7 550   | 16 645 | 8 650   | 19 070 | 9 200   | 20 280 | 10 000  | 22 045 | 10 950  | 24 140 |
| 30       | 20   | 3 780   | 8 335  | 4 660   | 10 275 | 5 680   | 12 520 | 6 450   | 14 220 | 7 200   | 15 875 | 8 250   | 18 190 | 8 800   | 19 400 | 9 550   | 21 055 | 10 450  | 23 040 |
| 40       | 25   | 3 400   | 7 495  | 4 200   | 9 260  | 5 100   | 11 245 | 5 780   | 12 745 | 6 500   | 14 330 | 7 450   | 16 425 | 7 900   | 17 415 | 8 600   | 18 960 | 9 400   | 20 725 |
| 50       | 30   | 3 040   | 6 700  | 3 740   | 8 245  | 4 540   | 10 010 | 5 160   | 11 375 | 5 760   | 12 700 | 6 600   | 14 550 | 7 050   | 15 540 | 7 650   | 16 865 | 8 350   | 18 410 |
| 65       | 40   | 2 500   | 5 510  | 3 075   | 6 780  | 3 750   | 8 265  | 4 250   | 9 370  | 4 750   | 10 470 | 5 450   | 12 015 | 5 800   | 12 785 | 6 300   | 13 890 | 6 900   | 15 210 |

**Notice!**

Exceeding maximum speed leads to tire overheating resulting in premature break-up.

**Q: FOR THE TIRE, WHAT ARE THE REQUIRED (MINIMUM) INFLATION PRESSURES WHEN:**

- 1) Driving on the road?
- 2) Working on the field?

**Tire:** 710/55R34 177 D

**Load per tire:** 7 000 kg / 15 432 lb

**A:**

- 1) Vehicle keeps maximum speed in 50 km/h / 30 mph.

With this load the minimum inflation pressure is 2.8 bar/41 psi.

- 2) Maximum speed in field applications is 10 km/h / 5 mph.

With this load the minimum inflation pressure is 1.6 bar / 23 psi.

**SIZE 710/55R34 177 D**

|              | Constant | 0.8 bar | 12 psi | 1.2 bar | 17 psi | 1.6 bar | 23 psi | 2.0 bar | 29 psi | 2.4 bar | 35 psi | 2.8 bar | 41 psi | 3.2 bar | 46 psi | 3.6 bar | 53 psi | 4.0 bar | 58 psi |        |
|--------------|----------|---------|--------|---------|--------|---------|--------|---------|--------|---------|--------|---------|--------|---------|--------|---------|--------|---------|--------|--------|
|              | km/h     | mph     | kg     | lbs     | kg     | lbs     | kg     | lbs     | kg     | lbs     | kg     | lbs     | kg     | lbs     | kg     | lbs     | kg     | lbs     | kg     | lbs    |
| <b>Field</b> | 10       | 5       | 4 780  | 10 540  | 5 860  | 12 920  | 7 200  | 15 875  | 8 100  | 17 855  | 9 300  | 20 505  | 10 450 | 23 040  | 11 100 | 24 470  | 12 100 | 26 675  | 13 150 | 28 990 |
|              | 20       | 12.5    | 4 380  | 9 655   | 5 380  | 11 860  | 6 600  | 14 550  | 7 450  | 16 425  | 8 500  | 18 740  | 9 600  | 21 165  | 10 150 | 22 375  | 11 100 | 24 470  | 12 050 | 26 565 |
|              | 25       | 15      | 4 200  | 9 260   | 5 140  | 11 330  | 6 350  | 14 000  | 7 150  | 15 765  | 8 150  | 17 965  | 9 200  | 20 280  | 9 750  | 21 495  | 10 600 | 23 370  | 11 550 | 25 465 |
|              | 30       | 20      | 4 020  | 8 860   | 4 920  | 10 845  | 6 050  | 13 340  | 6 800  | 14 990  | 7 800  | 17 195  | 8 800  | 19 400  | 9 300  | 20 505  | 10 150 | 22 375  | 11 050 | 24 360 |
|              | 40       | 25      | 3 620  | 7 980   | 4 420  | 9 745   | 5 440  | 11 995  | 6 150  | 13 560  | 7 050  | 15 540  | 7 900  | 17 415  | 8 400  | 18 520  | 9 150  | 20 170  | 9 950  | 21 935 |
| <b>Road</b>  | 50       | 30      | 3 220  | 7 100   | 3 940  | 8 685   | 4 840  | 10 670  | 5 460  | 12 035  | 6 250  | 13 780  | 7 050  | 15 540  | 7 450  | 16 425  | 8 150  | 17 965  | 8 850  | 19 510 |
|              | 65       | 40      | 2 650  | 5 840   | 3 250  | 7 165   | 4 000  | 8 820   | 4 500  | 9 920   | 5 150  | 11 355  | 5 800  | 12 785  | 6 150  | 13 560  | 6 700  | 14 770  | 7 300  | 16 095 |

# LIMITED WARRANTY

## READ OUR WARRANTIES ONLINE

**Nokian Heavy Tyres limited warranty**

**Intuitu™ Sensor limited warranty**

**Extended warranty for users of the Intuitu mobile application**

Go to [nokiantyres.com/warrantyinfomation/](https://nokiantyres.com/warrantyinfomation/) or click on the link in the Intuitu app.

Nokian Heavy Tyres' liability shall be limited to the aforesaid limited warranties and shall only be valid as stipulated in the limited warranties.

# GENERAL TERMS OF DELIVERY

## 1. DEFINITIONS

1.1. The following definitions shall apply to these General Terms of Delivery and to any Agreement:

“Agreement” shall mean a signed document (including its appendices) referring to these General Terms of Delivery or to which these General Terms of Delivery are attached or any other agreement between the Parties concluded as stipulated in section 2.2.

“Buyer” shall mean a Party purchasing the Products.

“Force Majeure Event” shall mean events beyond the control of a Party which occur after the Agreement entered into force and which were not reasonably foreseeable at the time the Agreement entered into force and whose effects are not capable of being overcome without unreasonable expense and/or loss of time to the Party concerned. Events of Force Majeure will include (without being limited to) epidemic, pandemic, war, civil unrest, strikes, lockouts and other general labour disputes, acts of government, natural disasters, exceptional weather conditions, breakdown or general unavailability of transport facilities, accidents, fire, flood, explosions and general shortages of

energy.

“Intellectual Property Rights” shall mean patents (including petty patents and utility models), design patents, and designs (whether or not capable of registration), copyright, trademark, service mark, and any other form of statutory or common law intellectual property protection of any kind; and applications for any of the foregoing including without limitation reissues, divisions, or other continuations thereof, in all jurisdictions, where applicable.

“Party” shall mean either Nokian Tyres or the Buyer.

“Products” shall mean tires, tire sensors, studs and anti-slip devices, or other products developed and manufactured by or for Nokian Tyres. The Products shall be those specified in the Agreement or those agreed between the Parties from time to time.

“Nokian Tyres” shall mean Nokian Tyres plc and any of its affiliate companies.

“Restricted Person” shall mean a person, organization or entity that is:

(i) listed on a sanctions list, including but not limited to “Specifically Designated Nationals and Blocked Persons” maintained by OFAC in U.S., “Consolidated List of Financial Sanctions Targets in the UK” maintained by HMT in UK; (ii) located or resident in or incorporated under the laws of a country or territory that is, or whose government is, the target of a country-wide or territory-wide Trade Restriction; (iii) owned or controlled by a Restricted Person; or (iv) otherwise a target of a Trade Restriction.

“Trade Restrictions” shall mean export and import laws, orders, and licenses, embargoes, sanctions of an economic, commercial or financial nature, regulations on sectors subject to restrictions (such as use for military purposes), regulations concerning Restricted Persons and other restrictive measures of similar nature, as existing, amended, supplemented and substituted from time to time, administrated, enacted or enforced by United Nations, United States of America (including OFAC), European Union or any of its member states, countries of European Economic Area, United Kingdom (including HTM), any other competent jurisdiction or any competent authority of the above. Trade Restrictions also include any other restrictions that may have any direct or indirect impact of any nature on Nokian Tyres or its subsidiaries irrespective of the

country/government/ authority by which the Trade Restriction is administered, enacted or enforced.

## 2. ENTRY INTO FORCE OF AGREEMENT

2.1. The Agreement enters into force when signed by both Parties.

2.2. The Agreement enters also into force when the Buyer accepts in writing Nokian Tyres's tender regarding the delivery of the Products or when Nokian Tyres accepts the Buyer's purchase order regarding the delivery of the Products in writing or by delivering the Products specified in such purchase order.

2.3. No Buyer's terms in Buyer's request for tender, purchase order or any other document will form part of the Agreement unless specifically approved in writing by Nokian Tyres. The Buyer expressly waives any right to rely on such terms.

## 3. PRODUCTS AND SERVICES

3.1. Nokian Tyres reserves the right to apply quantity limits on any purchase order, to reject all or part of a purchase order, and to discontinue or make changes to Products without notice, even if Buyer has already placed a purchase order. Also,

even if a purchase order has been accepted, Nokian Tyres may subsequently cancel such purchase order in whole or in part due to product unavailability (including without limitation, any discontinuation of the Product).

3.2. Nokian Tyres may offer ancillary services related to the Products such as mobile applications for tire monitoring. Services are subject to separate terms and conditions with which Buyer undertakes to comply when using the services.

## 4. DELIVERY

4.1. The delivery term of the Products shall be FCA, premises named by Nokian Tyres (Incoterms 2020), unless otherwise agreed by the Parties.

4.2. The Buyer shall inspect the Products after the delivery. The delivery shall be deemed accepted if the Buyer has not presented Nokian Tyres with a written remark regarding the delivery of the Products within seven (7) days from the delivery date.

4.3. Nokian Tyres shall deliver the Products at the agreed time of delivery. If the time of delivery has not been agreed in writing, Nokian Tyres shall deliver the Products within a reasonable time from the entry into force of the Agreement provided that the Products are available or, if the Products are not available, within a reasonable

time after they become available. Even though Nokian Tyres agrees to take all commercially reasonable measures to meet the agreed delivery dates, the Buyer acknowledges and agrees that Nokian Tyres shall not be liable for its failure to meet the agreed delivery dates.

4.4. If Nokian Tyres has outstanding due receivables from the Buyer, Nokian Tyres has the right to refrain from delivering the Products until the Buyer has settled the due payments in full. In such an event, the agreed delivery time will be extended correspondingly.

4.5. Nokian Tyres shall be entitled to make also partial deliveries.

## 5. PRICE AND TERMS OF PAYMENT

5.1. The prices of the Products have been agreed in the Agreement. Unless otherwise agreed in writing, Nokian Tyres' price list in force at the time of entry into force of the Agreement shall be applied. Nokian Tyres can issue changes to applicable price lists with a prior notice of one (1) month. Prices do not include any value added or similar taxes, which shall be added to all prices according to the laws and regulations in force at the time of the delivery. All Products shall be invoiced and payments made in Euro currency (EUR).

5.2. When the amount of or basis for taxes or other public payments changes before the delivery of the Products, either due to regulation change or change in the practice, Nokian Tyres has the right to adjust the prices of the Products correspondingly.

5.3. Unless otherwise stipulated by Nokian Tyres in writing, any offer issued by Nokian Tyres to the Buyer is valid for three (3) months from the date of issuance of the offer.

5.4. Unless otherwise agreed in writing, the Products will be invoiced after the date of delivery. Payment shall be due within thirty (30) days of the date of the invoice. The Buyer is obliged to pay eleven and a half (11.5) percent of annual interest on overdue payments beginning from the due date.

5.5. If Nokian Tyres has agreed to grant credit to the Buyer for the payment of the Products, Buyer is upon Nokian Tyres' request obliged to provide Nokian Tyres all necessary financial information (including but not limited to financial statements of the company) that is needed to grant the credit and assess the creditworthiness of the Buyer during the credit period. The obligation to provide financial information to Nokian Tyres continues as long as there is any open credit i.e. unpaid receivables from Buyer. For sake of clarity, the granting of any credit is at the sole discretion of Nokian Tyres and subject to a separate

decision made by Nokian Tyres.

## 6. TRANSFER OF RISK AND TITLE

6.1. Products delivered shall remain, to the extent permitted by applicable law, the property of Nokian Tyres until the Buyer has paid the price of the Products and the value added or similar taxes related to the respective Products. The Buyer shall give Nokian Tyres all necessary assistance in taking any measures to protect Nokian Tyres' title to the Products.

6.2. Until the title to the Products passes to the Buyer in accordance with Section 5.1 above, the Buyer shall store the Products at no costs to Nokian Tyres separately from all other products in its possession and mark the Products so that they are clearly identified as Nokian Tyres' property.

6.3. Notwithstanding the fact that the Products remain the property of Nokian Tyres, the Buyer may sell or use the Products in the ordinary course of the Buyer's business at full market value for the account of Nokian Tyres. Any such sale or use shall be a sale or use of Nokian Tyres' property by the Buyer and the Buyer shall act as the principal when making such sales or dealings. Until the title to the Products passes from Nokian Tyres to the Buyer, the entire proceeds from the sale or other dealings of the Products shall be

held in trust for Nokian Tyres and shall not be mixed with other money or paid into any overdrawn bank account of the Buyer and shall be at all times identified as Nokian Tyres' money. Also, until the title to the Products passes from Nokian Tyres to the Buyer, the Buyer shall assign its outstanding claims arising from the resale of the Products to Nokian Tyres as a security for Nokian Tyres' claims.

6.4. Until the title to the Products passes from Nokian Tyres to the Buyer, the Buyer shall upon Nokian Tyres' request return the delivered and unsold Products to Nokian Tyres. If the Buyer fails to do so, Nokian Tyres may enter upon any premises owned or occupied or controlled by the Buyer where the Products are supposed to be situated and repossess the Products. Upon such repossession, the rights of the Buyer under the Agreement with respect to the Products in question shall terminate.

6.5. The Buyer shall not pledge any of the Products which are still owned by Nokian Tyres. Without prejudice to any other rights of Nokian Tyres, if the Buyer does so, all sums whatsoever owed by the Buyer to Nokian Tyres shall become immediately due and payable.

6.6. The Buyer shall insure and keep insured the Products to their full market value against all risks to the reasonable satisfaction of Nokian Tyres until the date when the title to the Products

passes from Nokian Tyres to the Buyer, and shall whenever requested by Nokian Tyres produce a copy of the respective insurance policy. Without prejudice to the other rights of Nokian Tyres, if the Buyer fails to do so, all sums whatsoever owed by the Buyer to Nokian Tyres shall become immediately due and payable.

6.7. Notwithstanding the fact that the title to the Products shall remain with Nokian Tyres in accordance with the above provisions, the risk of damage or loss of the Products shall pass to the Buyer at the following times: (a) in the case the Products are to be delivered at Nokian Tyres's premises, at the time when Nokian Tyres notifies the Buyer that the Products are available for collection; or (b) in the case the Products are to be delivered otherwise than at Nokian Tyres's premises, at the time determined in the applicable delivery term.

## 7. WARRANTIES

7.1. Nokian Tyres' warranty terms concerning the Products are set out in Nokian Heavy Tyres' limited warranty terms valid at the time of the delivery. EXCEPT AS SET FORTH IN SUCH WARRANTY TERMS, THERE ARE NO OTHER EXPRESS OR IMPLIED WARRANTIES, INCLUDING BUT NOT LIMITED TO ANY IMPLIED WARRANTIES OF MERCHANTABILITY OR FITNESS FOR A PARTICULAR PURPOSE. To the maximum extent permitted by the applicable law, Nokian Tyres

shall have no other obligations or liabilities with respect to any possible defect or deficiency in the Products delivered hereunder than as set forth in the above-mentioned warranty terms.

## 8. LIABILITY AND CLAIMS

8.1. To the extent permitted by the applicable law, under no circumstances shall Nokian Tyres' liability under this Agreement exceed the invoice price of any Products with respect to which a claim is made.

8.2. Under no circumstances shall Nokian Tyres be liable under this Agreement for any indirect or consequential damage or loss, including without limitation any increased costs or expenses, or loss of profit, business, contracts, revenues or anticipated savings.

8.3. When Nokian Tyres has expressly agreed with the Buyer on the return of any of the delivered Products to Nokian Tyres, the Buyer assumes full responsibility for ensuring that the Products are placed in Nokian Tyres' possession. Nokian Tyres shall not accept any liability for any loss of any Products in transit.

8.4. The Buyer acknowledges and agrees to that any data generated by Nokian Tyres' digital services regarding the use of Products can be used in processing of claims made by the Buyer towards Nokian Tyres.

## 9. SPECIFICATIONS AND INTELLECTUAL PROPERTY RIGHTS

9.1. The weights, dimensions, capacities, prices, performance ratings and other data included in catalogues, prospectuses, circulars, advertisements and price lists and other similar information regarding the Products, as expressed in Nokian Tyres' general product information, constitute an approximate guide. This data shall not be binding on Nokian Tyres, save to the extent that it is by reference expressly included in the Agreement.

9.2. No right or license is granted under the Agreement to the Buyer under any patent, trademark, copyright, registered design or other Intellectual Property Rights, except for the right to use or resell the Products.

9.3. All Products sold in retail packaging may be resold by the Buyer only in the packaging supplied by Nokian Tyres and in no case may any trademark other than those applied by Nokian Tyres be marked on or applied in relation to the Products.

## 10. CONFIDENTIALITY

10.1. The Buyer undertakes to keep confidential all terms and conditions of the Agreement and its appendices, as well as all information given on

Nokian Tyres' or its business partners' operations, products and services and any information regarded as trade secrets of Nokian Tyres. The Buyer shall not (and shall secure that its directors, agents and employees shall not) be entitled at any time without prior written consent of Nokian Tyres to disclose Nokian Tyres' confidential information to any third party or to use it whether directly or indirectly for other purposes than in accordance with the Agreement. The obligation of confidentiality shall survive the termination of the Agreement and remain in force for five (5) years thereafter.

10.2. The Section 10.1 shall not apply to any information which (i) the receiving Party can prove to have been in its possession at the date of receipt or (ii) which is or becomes public knowledge otherwise than through a breach of an obligation of confidentiality.

## 11. INTEGRITY AND CODE OF CONDUCT

11.1. The Nokian Tyres' Code of Conduct applies to the business relationship between the parties (available at Nokian Tyres' webpages). The Buyer agrees to comply with the principles set out therein, as amended from time to time. 11.2. The Buyer further warrants that the Buyer or any individuals or entities acting for or on behalf of the Buyer have not violated any applicable laws and regulations related to anti-trust and

competition, anti-corruption or money laundering and warrants that applicable anti-trust and competition, anti-corruption or money laundering laws and regulations are complied with in all its activities.

## 12. DATA PRIVACY

12.1. As a part of the cooperation under the Agreement, Nokian Tyres may collect and processes personal data about the representatives of the Buyer. Nokian Tyres processes the personal data in accordance with applicable data protection legislation. More information about for what purposes and how personal data is collected and processed by Nokian Tyres is available in Nokian Tyres' Privacy Statement, which is available at <https://www.nokiantyres.com/privacy-statement/>.

12.2. Unless otherwise agreed, the cooperation under the Agreement does not include any processing of personal data by one party on behalf of the other party, or any sharing or disclosure of personal data, and the parties agree that each party is independently responsible for complying with applicable data protection legislation with regard to the personal data they may process.

12.3. If the cooperation under the Agreement would include disclosing personal data from one party to another, but no party processes personal

data on behalf of the other party, the original controller of the personal data shall be responsible for ensuring that there is a legal basis for such disclosure.

## 13. TRADE RESTRICTIONS AND IMPORT/EXPORT CONTROLS

13.1. The Buyer warrants that it will comply in all respects with any Trade Restrictions for every Product delivered to the Buyer. The Buyer also assures that other individuals or entities acting for or on behalf of the Buyer comply with the Trade Restrictions.

13.2. The Buyer warrants that neither it nor any other Buyer belonging to same group of companies, nor any owner, beneficial owner, member of their board of directors nor any of their managing director nor any other director, employee, agent or representative or of any member of the group is currently a Restricted Person or have ever been a Restricted Person. The Buyer undertakes to inform Nokian Tyres without delay if any person or Buyer mentioned above shall become subject to a Trade Restriction.

13.3. Accordingly, the Buyer undertakes:

a) to obtain, at its own expense, any licenses, shipping documents and authorizations or

approvals to export or import the Products as may be required; and

b) not to advertise, market, promote, sell, lease or otherwise transfer the purchased Products to Restricted Person or to restricted countries/areas subject to Trade Restriction; and

c) not to advertise, market, promote, sell, lease or otherwise transfer the purchased Products for the purpose of using them in restricted sectors, insofar as the transfer is restricted according to a Trade Restriction and insofar as a license or approval has not been obtained; and

d) to comply with any applicable Trade Restrictions with regard to issuance of payments and finance associated with the Products.

13.4. The Buyer shall indemnify Nokian Tyres and hold Nokian Tyres harmless from and against any damages, liabilities or costs resulting from the Buyer's violation or alleged violation of the Trade Restrictions.

13.5. Nokian Tyres retains the right to cancel or delay delivery of any Product at any time without penalty or liability of any nature, as, at the sole discretion of Nokian Tyres, required with respect to a Trade Restrictions. The delivery may be delayed until a license, approval or similar is granted or for the duration of the restriction. If

purchased Products are transferred in violation of the Trade Restrictions, Nokian Tyres shall not be obligated to provide any warranty for the Products transferred.

13.6. Nokian Tyres is, at their sole discretion, also entitled to terminate the Agreement with immediate effect without penalty or liability of any nature if a delivery of any Product or any other performance of either Party under the Agreement may result in violation of any Trade Restriction.

13.7. Nokian Tyres shall be entitled to audit the Buyer's compliance with obligations relating to these matters. The Buyer shall supply on request all necessary information to verify compliance.

13.8. As a customer of Nokian Tyres, the Buyer may have been required to provide certain information of the Buyer to Nokian Tyres in accordance with Nokian Tyres' client onboarding process before the signing of this Agreement. The Buyer undertakes to inform Nokian Tyres immediately if there are any changes to the information provided as part of Nokian Tyres' customer onboarding process.

## 14. TERM AND TERMINATION

14.1. The Agreement shall be in full force and effect (i) until Parties' obligations under the

Agreement have been fulfilled or (ii) in case of a continuous agreement until terminated by either party for any reason with at least three (3) months prior written notice. Termination of a continuous Agreement in accordance with this section 14.1 shall not relieve neither Party from any obligations related to orders accepted before termination.

14.2. The Agreement may be terminated with immediate effect by the non-defaulting Party with a written notice to the other Party in the event that (a) the other Party commits a material breach of the Agreement and fails to remedy such breach (if capable of being remedied) within thirty (30) days after having been notified thereof in writing; or (b) the other Party commits an act of bankruptcy, is placed in liquidation or becomes otherwise incapable of fulfilling its financial obligations under the Agreement, or should it become apparent that any of the above occurrences shall take place.

14.3. Furthermore, the Agreement may be terminated with immediate effect with a written notice by Nokian Tyres to the Buyer in the event that (a) there is a direct or indirect change of ownership or control or other substantial change in the management, staff or the business operations of the Buyer which may adversely affect achieving the purpose of the Agreement; (b) Buyer violates any of its obligations under sections 9, 10, 11, 12 or 13; or (c) the Buyer enters

into an agreement with a third party or engages itself in any activity which prejudices the confidentiality of Nokian Tyres' confidential material or information.

14.4. Upon termination of the Agreement due to the Buyer's breach, Nokian Tyres shall have the right to do one or more of the following: (a) revoke any express or implied authority to sell, resell, use or consume any Products whose title has not passed to the Buyer and re-sell such Products; (b) suspend any deliveries to be made under any agreement with the Buyer; and/or (c) make claim against the Buyer for the price of the unpaid Products and/ or damages.

## 15. OTHER TERMS

15.1. In case of conflict, the Agreement shall take precedence over these General Terms of Delivery, and these General Terms of Delivery shall take precedence over any other appendices of the Agreement.

15.2. The Agreement constitutes the entire agreement between the parties with respect to the subject matter and supersedes all other prior agreements and understandings, both written and oral, between the parties with respect to the subject matter.

15.3. Neither Party shall be liable to the other Party for any delay or non-performance of its

obligations under the Agreement in the event and to the extent that such delay or non-performance is due to an Force Majeure Event.

15.4. The Agreement and these General Terms of Delivery shall be construed and enforced in accordance with the laws of Finland, excluding its choice of law provisions and Convention on Contracts for the International Sale of Goods (CISG). Any dispute, controversy or claim arising out of or relating to the Agreement, or the breach, termination or validity thereof, shall be finally settled in arbitration by one (1) arbitrator in accordance with the Arbitration Rules of the Central Chamber of Commerce of Finland. The arbitration shall be conducted in Helsinki.